

Data Sheet

R-Series V RDV EtherCAT®

Magnetostrictive Linear Position Sensors

- Space-saving installation due to detached sensor electronics housing
- Backwards compatible with RD4 generation
- All advantages of the R-Series V



V
THE NEW GENERATION

MEASURING TECHNOLOGY

The absolute, linear position sensors provided by Temposonics rely on the company's proprietary magnetostrictive technology, which can determine position with a high level of precision and robustness. Each Temposonics® position sensor consists of a ferromagnetic waveguide, a position magnet, a strain pulse converter and a supporting electronics. The magnet, connected to the object in motion in the application, generates a magnetic field at its location on the waveguide. A short current pulse is applied to the waveguide. This creates a momentary radial magnetic field and torsional strain on the waveguide. The momentary interaction of the magnetic fields releases a torsional strain pulse that propagates the length of the waveguide. When the ultrasonic wave reaches the beginning of the waveguide it is converted into an electrical signal. Since the speed of the ultrasonic wave in the waveguide is precisely known, the time required to receive the return signal can be converted into a linear position measurement with both high accuracy and repeatability.

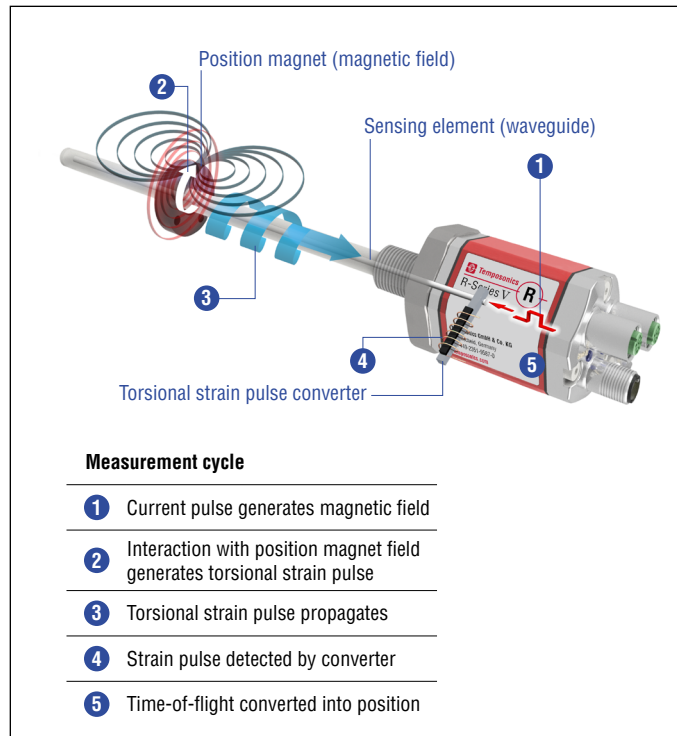
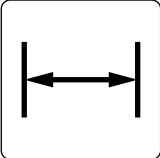
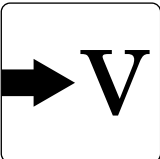



Fig. 1: Time-of-flight based magnetostrictive position sensing principle

R-SERIES V RDV EtherCAT®

The Temposonics® R-Series V brings very powerful sensor performance to meet the many demands of your application. The sensor RDV is the version of the R-Series V with a detached sensor electronics. The main advantages of the version RDV are:

- 

Space-saving installation
The detached sensor electronics allow space-saving installation of the compact measuring rod.
- 

R-Series V platform
The detached sensor electronics is based on the R-Series V and offers all advantages of the innovative series.
- 

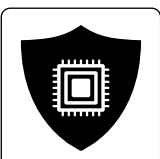
Backwards compatible
Mechanically and electrically, the sensors are backwards compatible with the RD4. This means that the sensor rod or the sensor electronics can be replaced without any problems.
- 

Protection of the sensor electronics
By separating the robust sensor rod from the complex evaluation electronics improved protection against process influences can be realized.

In addition the R-Series V EtherCAT® scores with the following features:

- 

30 positions simultaneously
The R-Series V EtherCAT® can detect and report the position, velocity and acceleration of up to 30 magnets simultaneously.
- 

R-Series V EtherCAT®
In addition to the measured position value via the EtherCAT® protocol further data about the current sensor status, such as the total distance travelled, the internal temperature and the total operating hours, can be displayed for diagnostic purposes.

All settings under control with the smart assistants for the R-Series V

The TempoLink® and the TempoGate® smart assistants support you in setup and diagnostics of the R-Series V. For more information of these assistants please see the data sheets:

- TempoLink® smart assistant (Document part number: [552070](#))
- TempoGate® smart assistant (Document part number: [552110](#))

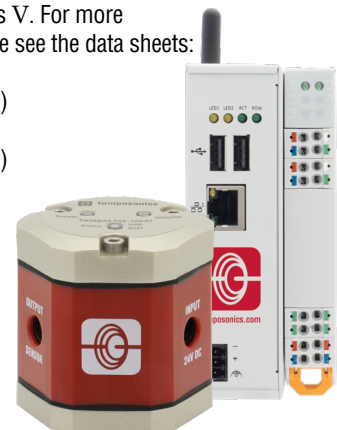

TECHNICAL DATA

Output							
Interface	EtherCAT® Ethernet Control Automation Technology						
Data protocol	EtherCAT® 100 Base-Tx, Fast Ethernet						
Data transmission rate	100 MBit/s max.						
Measured value	Position, velocity and acceleration/option: Simultaneous multi-position, multi-velocity and multi-acceleration measurements up to 30 magnets						
Measurement parameters							
Resolution: Position	0.5...1000 µm (selectable)						
Native cycle time	Stroke length	25 mm	300 mm	750 mm	1000 mm	2000 mm	5080 mm
	Cycle time	100 µs	294 µs	370 µs	476 µs	833 µs	2273 µs
Extrapolation cycle time	Number of magnets	≤ 10 magnets		11...30 magnets			
	Cycle time	100 µs		250 µs			
Linearity deviation ^{1, 2}	Stroke length	≤ 500 mm		> 500 mm			
	Linearity deviation	≤ ±50 µm		< 0.01 % F.S.			
	Optional internal linearity: Linearity tolerance (Applies for the first magnet for multi-position measurement)						
	Stroke length	25...300 mm	300...600 mm	600...1200 mm			
	typical	±15 µm	±20 µm	±25 µm			
maximum	±25 µm	±30 µm	±50 µm				
Repeatability	< ±0.001 % F.S. (minimum ±2.5 µm)						
Hysteresis	< 4 µm typical						
Temperature coefficient	< 15 ppm/K typical						
Operating conditions							
Operating temperature	-40...+85 °C (-40...+185 °F)						
Humidity	90 % relative humidity, no condensation						
Ingress protection	Sensor electronics: IP67 (with correctly mounted housing and connectors) Measuring rod with connecting cable for side cable entry: IP65 Measuring rod with single wires and flat connector with bottom cable entry: IP30						
Shock test	100 g/11 ms, IEC standard 60068-2-27						
Vibration test	10 g/10...2000 Hz, IEC standard 60068-2-6 (excluding resonant frequencies)						
EMC test	Electromagnetic emission according to EN 61000-6-3						
	Electromagnetic immunity according to EN 61000-6-2 The RDV sensors fulfill the requirements of the EMC directives 2014/30/EU, UKSI 2016 No. 1091 and TR CU 020/2011 under the condition of an EMC-compliant installation. ³						
Operating pressure	350 bar (5076 psi)/700 bar (10,153 psi) peak (at 10 × 1 min) for sensor rod						
Magnet movement velocity	Any						
Design/Material							
Sensor electronics housing	Aluminum (painted), zinc die cast						
Sensor rod with flange	Stainless steel 1.4301 (AISI 304)						
RoHS compliance	The used materials are compliant with the requirements of EU Directive 2011/65/EU and EU Regulation 2015/863 as well as UKSI 2022 No. 622						
Stroke length	25...2540 mm (1...100 in.) for pressure-fit flange »S«						
	25...5080 mm (1...200 in.) for all threaded flanges						

1/ With position magnet # 251 416-2

2/ For rod style »S« the linearity deviation can be higher in the first 30 mm (1.2 in.) of stroke length

3/ The cable between the sensor element and the electronic housing must be mounted in an appropriately shielded environment.

Mechanical mounting	
Mounting position	Any
Mounting instruction	Please consult the technical drawings on page 5 , page 6 , page 7 and the operation manual (document number: 552059)
Electrical connection	
Connection type	2 × M12 female connectors (5 pin), 1 × M12 male connector (4 pin) 2 × M12 female connectors (5 pin), 1 × M8 male connector (4 pin)
Operating voltage	+12...30 VDC ±20 % (9.6...36 VDC)
Power consumption	Less than 4 W typical
Dielectric strength	500 VDC (DC ground to machine ground)
Polarity protection	Up to -36 VDC
Overvoltage protection	Up to 36 VDC

TECHNICAL DRAWING

RDV with bottom cable entry

- The connecting cables between the sensor electronics housing and the rod are routed into the interior via the bottom of the sensor electronics housing
- Rod and connecting cable are fully encapsulated and protected against external disturbances

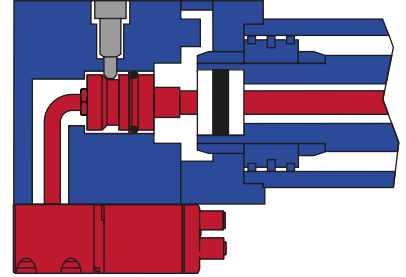

RDV with bottom cable entry, example: Connector D56 (connector outlet)

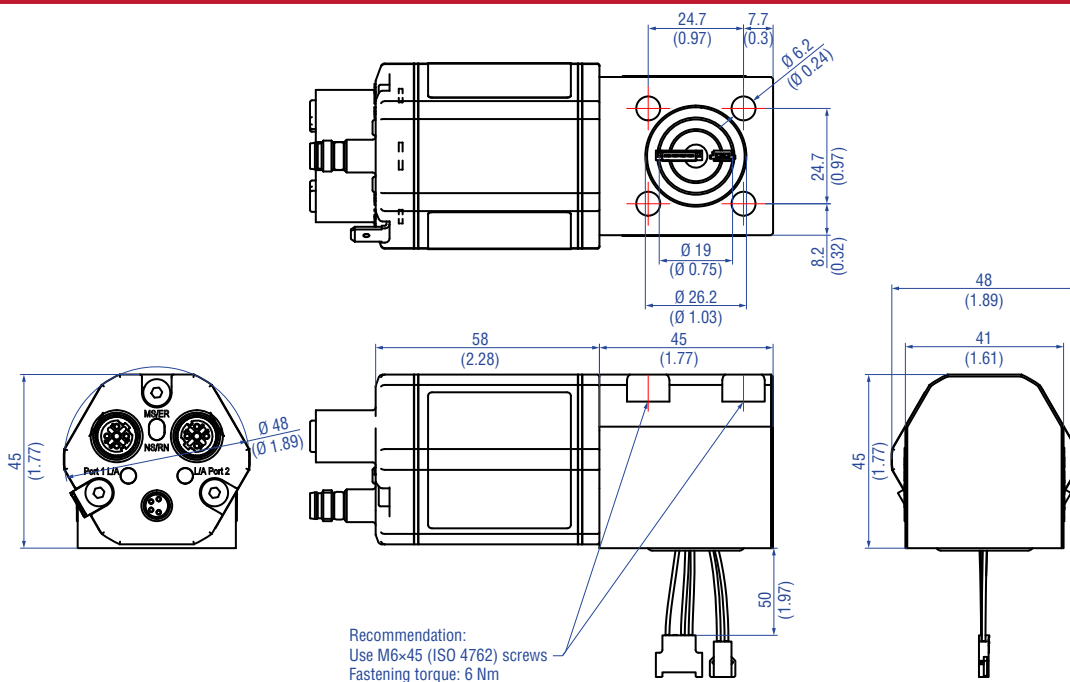

Controlling design dimensions are in millimeters and measurements in () are in inches

Fig. 2: Temposonics® RDV sensor electronics housing with bottom cable entry

RDV with side connection

- The connecting cable between the sensor electronics housing and the rod is connected to the side of the sensor electronics housing
- Rod and connecting cable are sealed against dust and protected against water jets

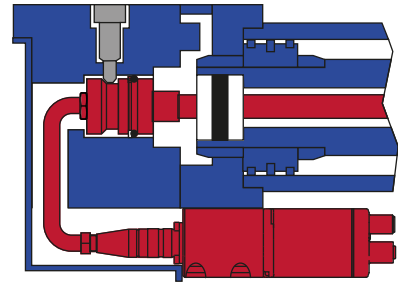

RDV with side cable entry, example: Connector D58 (connector outlet)

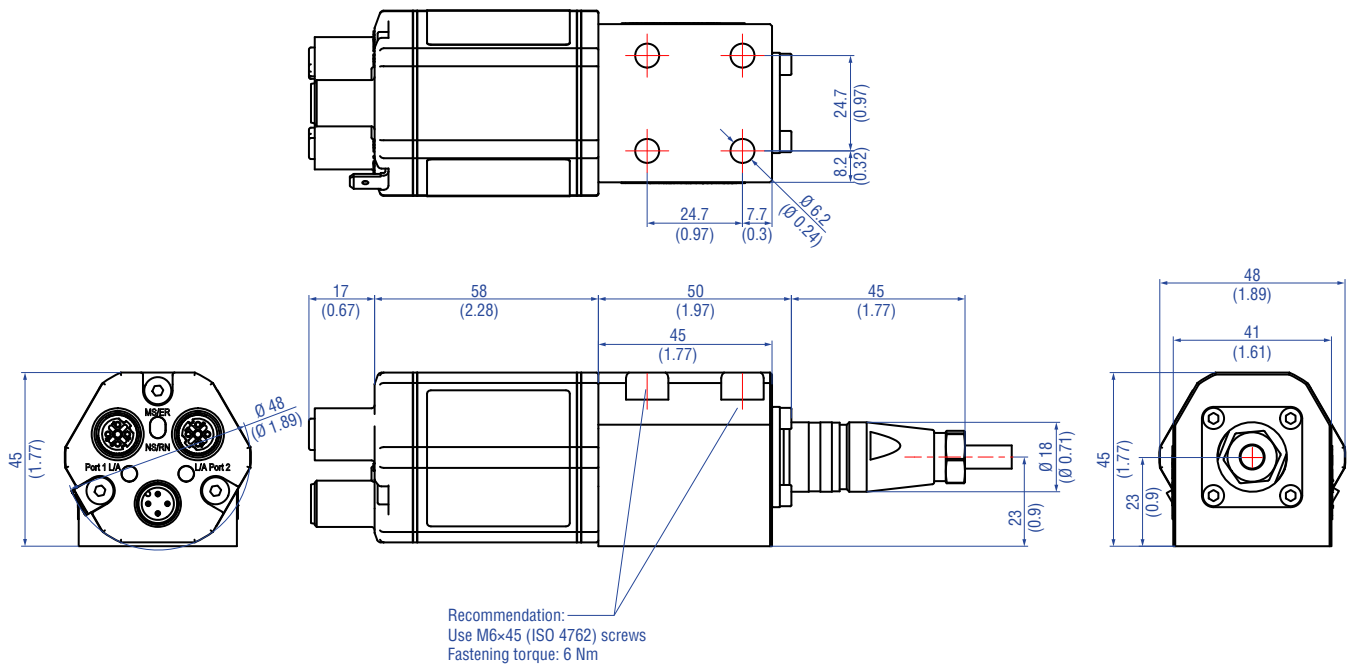

Controlling design dimensions are in millimeters and measurements in () are in inches

Fig. 3: Temposonics® RDV sensor electronics housing with side cable entry

Threaded flange »C« & »D« (for bottom or side cable entry)

PUR cable:
Ø 6 (Ø 0.24)
Bending radius:
> 24 (> 0.94)
Cable length (bottom cable entry):
65/170/230/350
(2.6/6.7/9.1/13.8)
Cable length (side cable entry):
250/400/600
(9.8/15.7/23.6)

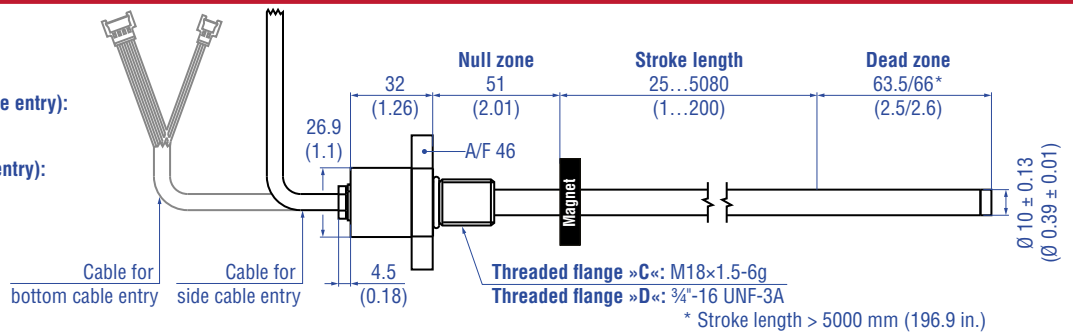

Threaded flange »M« (for bottom or side cable entry)

PUR cable:
Ø 6 (Ø 0.24)
Bending radius:
> 24 (> 0.94)
Cable length (bottom cable entry):
65/170/230/350
(2.6/6.7/9.1/13.8)
Cable length (side cable entry):
250/400/600
(9.8/15.7/23.6)

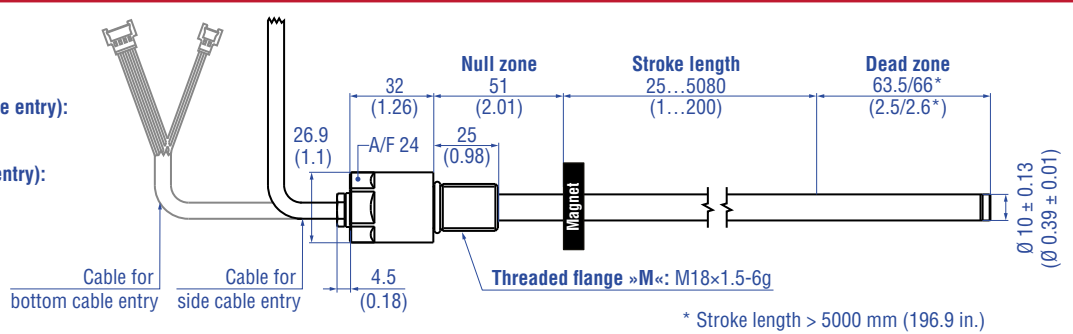

Threaded flange »T« (for bottom or side cable entry)

PUR cable:
Ø 6 (Ø 0.24)
Bending radius:
> 24 (> 0.94)
Cable length (bottom cable entry):
65/170/230/350
(2.6/6.7/9.1/13.8)
Cable length (side cable entry):
250/400/600
(9.8/15.7/23.6)

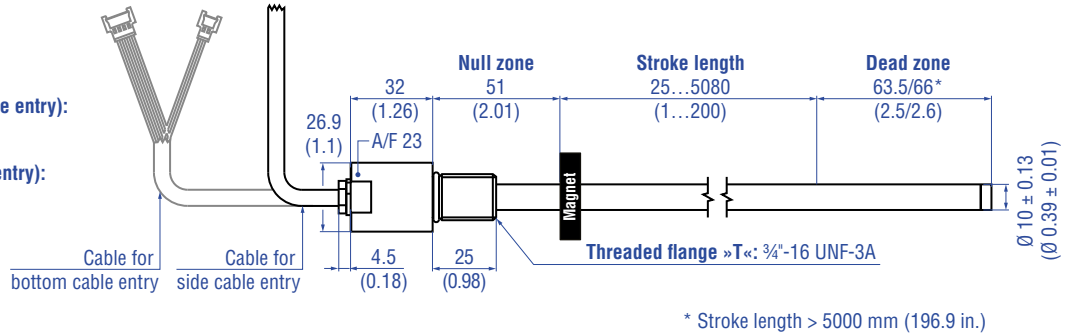

Pressure fit flange »S« (for bottom or side cable entry)

PUR cable:
Ø 6 (Ø 0.24)
Bending radius:
> 24 (> 0.94)
Cable length (bottom cable entry):
65/170/230/350
(2.6/6.7/9.1/13.8)
Cable length (side cable entry):
250/400/600
(9.8/15.7/23.6)

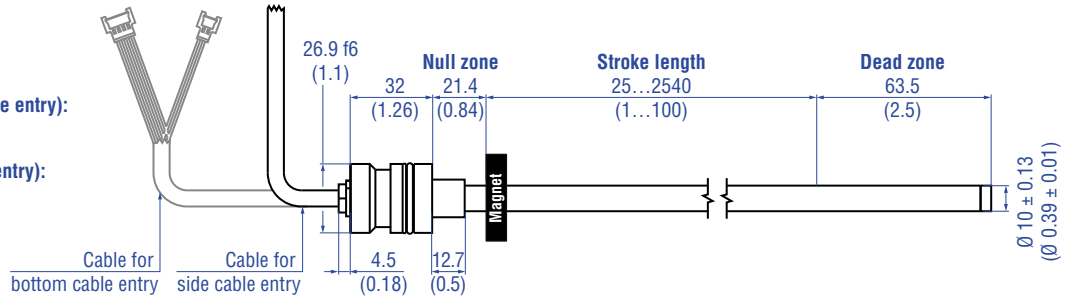

Controlling design dimensions are in millimeters and measurements in () are in inches

Fig. 4: Temposonics® RDV flange types

CONNECTOR WIRING



D58		
Port 1 – Signal		
M12 female connector (D-coded)	Pin	Function
 <p>View on sensor</p>	1	Tx (+)
	2	Rx (+)
	3	Tx (-)
	4	Rx (-)
Port 2 – Signal		
M12 female connector (D-coded)	Pin	Function
 <p>View on sensor</p>	1	Tx (+)
	2	Rx (+)
	3	Tx (-)
	4	Rx (-)
Power supply		
M12 male connector (A-coded)	Pin	Function
 <p>View on sensor</p>	1	+12...30 VDC (±20 %)
	2	Not connected
	3	DC Ground (0 V)
	4	Not connected

Fig. 5: Connector wiring D58



D56		
Port 1 – Signal		
M12 female connector (D-coded)	Pin	Function
 <p>View on sensor</p>	1	Tx (+)
	2	Rx (+)
	3	Tx (-)
	4	Rx (-)
Port 2 – Signal		
M12 female connector (D-coded)	Pin	Function
 <p>View on sensor</p>	1	Tx (+)
	2	Rx (+)
	3	Tx (-)
	4	Rx (-)
Power supply		
M8 male connector	Pin	Function
 <p>View on sensor</p>	1	+12...30 VDC (±20 %)
	2	Not connected
	3	DC Ground (0 V)
	4	Not connected

Fig. 6: Connector wiring D56

FREQUENTLY ORDERED ACCESSORIES – Additional options available in our [Accessories Catalog](#) 551444

Position magnets			
U-magnet OD33 Part no. 251 416-2	Ring magnet OD33 Part no. 201 542-2	Ring magnet OD25.4 Part no. 400 533	Ring magnet OD17.4 Part no. 401 032
Material: PA ferrite GF20 Weight: Approx. 11 g Surface pressure: Max. 40 N/mm ² Fastening torque for M4 screws: 1 Nm Operating temperature: -40...+105 °C (-40...+221 °F)	Material: PA ferrite GF20 Weight: Approx. 14 g Surface pressure: Max. 40 N/mm ² Fastening torque for M4 screws: 1 Nm Operating temperature: -40...+105 °C (-40...+221 °F)	Material: PA ferrite Weight: Approx. 10 g Surface pressure: Max. 40 N/mm ² Operating temperature: -40...+105 °C (-40...+221 °F)	Material: PA neobond Weight: Approx. 5 g Surface pressure: Max. 20 N/mm ² Operating temperature: -40...+105 °C (-40...+221 °F)
Marked version for sensors with internal linearization: Part no. 254 226	Marked version for sensors with internal linearization: Part no. 253 620	Marked version for sensors with internal linearization: Part no. 253 621	

Magnet spacer	O-rings		
Magnet spacer Part no. 400 633	O-ring for threaded flange M18x1.5-6g Part no. 401 133	O-ring for threaded flange 3/4"-16 UNF-3A Part no. 560 315	O-ring for pressure fit flange Ø 26.9 mm Part no. 560 705
Material: Aluminum Weight: Approx. 5 g Surface pressure: Max. 20 N/mm ² Fastening torque for M4 screws: 1 Nm	Material: Fluoroelastomer Durometer: 75 ± 5 Shore A Operating temperature: -40...+204 °C (-40...+400 °F)	Material: Fluoroelastomer Durometer: 75 ± 5 Shore A Operating temperature: -40...+204 °C (-40...+400 °F)	Material: Nitrile rubber Operating temperature: -53...+107 °C (-65...+225 °F)

O-rings	Mounting accessories		
Back-up ring for pressure fit flange Ø 26.9 mm Part no. 560 629	O-ring for mounting block with bottom entry Part no. 561 435	Hex jam nut M18x1.5-6g Part no. 500 018	Hex jam nut 3/4"-16 UNF-3A Part no. 500 015
Material: Polymyte Durometer: 90 Shore A	Material: FKM Durometer: 80 ± 5 Shore A Operating temperature: -15...+200 °C (5...+392 °F)	Material: Steel, zinc plated	Material: Steel, zinc plated

Controlling design dimensions are in millimeters and measurements in () are in inches

Mounting accessories

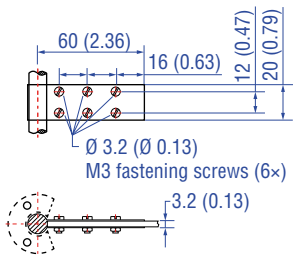

Fixing clip Part no. 561 481

Application: Used to secure sensor rods ($\varnothing 10$ mm ($\varnothing 0.39$ in.)) when using an U-magnet or block magnet
Material: Brass, non-magnetic

Cable connectors* – Signal

Cable connectors* – Power

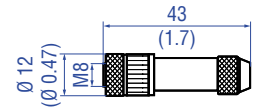
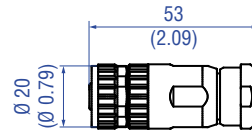
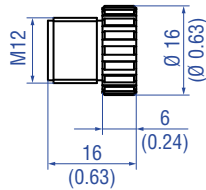
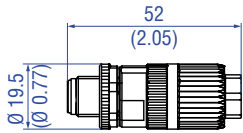

M12 D-coded male connector (4 pin), straight
Part no. 370 523

M12 connector end cap
Part no. 370 537

M12 A-coded female connector (4 pin/5 pin), straight
Part no. 370 677

M8 female connector (4 pin), straight
Part no. 370 504

Material: Zinc nickel-plated
Termination: Insulation-displacement
Cable Ø: 5.5...7.2 mm (0.2...0.28 in.)
Wire: 24 AWG – 22 AWG
Operating temperature:
–25...+85 °C (–13...+185 °F)
Ingress protection: IP65 / IP67 (correctly fitted)
Fastening torque: 0.6 Nm

Female connectors M12 should be covered by this protective cap
Material: Brass nickel-plated
Ingress protection: IP67 (correctly fitted)
Fastening torque: 0.39...0.49 Nm

Material: GD-Zn, Ni
Termination: Screw
Contact insert: CuZn
Cable Ø: 4...8 mm (0.16...0.31 in.)
Wire: 1.5 mm²
Operating temperature:
–30...+85 °C (–22...+185 °F)
Ingress protection: IP67 (correctly fitted)
Fastening torque: 0.6 Nm

Material: CuZn nickel plated
Termination: Solder
Cable Ø: 3.5...5 mm (0.14...0.28 in.)
Wire: 0.25 mm²
Operating temperature:
–40...+85 °C (–40...+185 °F)
Ingress protection: IP67 (correctly fitted)
Fastening torque: 0.5 Nm

Cables

Cable sets

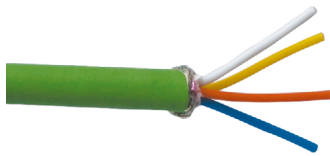

PUR signal cable
Part no. 530 125

PVC power cable
Part no. 530 108

Signal cable with M12 D-coded male connector (4 pin), straight – M12 D-coded, male connector (4 pin), straight
Part no. 530 064

Signal cable with M12 D-coded male connector (4 pin), straight – RJ45 male connector, straight
Part no. 530 065





Material: PUR jacket; green
Features: Cat 5, highly flexible, halogen free, suitable for drag chains, mostly oil & flame resistant
Cable Ø: 6.5 mm (0.26 in.)
Cross section: 2 × 2 × 0.35 mm² (22 AWG)
Bending radius: 5 × D (fixed installation)
Operating temperature:
–20...+60 °C (–4...+140 °F)

Material: PVC jacket; gray
Features: Shielded, flexible, mostly flame resistant
Cable Ø: 4.9 mm (0.19 in.)
Cross section: 3 × 0.34 mm²
Bending radius: 5 × D (fixed installation)
Operating temperature:
–30...+80 °C (–22...+176 °F)

Material: PUR jacket; green
Features: Cat 5e
Cable length: 5 m (16.4 ft)
Cable Ø: 6.5 mm (0.26 in.)
Ingress protection: IP65, IP67, IP68 (correctly fitted)
Operating temperature:
–30...+70 °C (–22...+158 °F)

Material: PUR jacket; green
Features: Cat 5e
Cable length: 5 m (16.4 ft)
Cable Ø: 6.5 mm (0.26 in.)
Ingress protection M12 connector: IP67 (correctly fitted)
Ingress protection RJ45 connector: IP20 (correctly fitted)
Operating temperature:
–30...+70 °C (–22...+158 °F)

*/ Follow the manufacturer's mounting instructions
Controlling design dimensions are in millimeters and measurements in () are in inches
Color of connectors and cable jacket may change. Colors of the cores and technical properties remain unchanged.

Cable sets	Programming tools		
			
<p>Power cable with M8 female connector (4 pin), straight – pigtail Part no. 530 066 (5 m (16.4 ft.)) Part no. 530 096 (10 m (32.8 ft.)) Part no. 530 093 (15 m (49.2 ft.))</p>	<p>Power cable with M12 A-coded female connector (5 pin), straight – pigtail Part no. 370 673</p>	<p>TempoLink® kit for Temposonics® R-Series V Part no. TL-1-0-EM08 (D56) Part no. TL-1-0-EM12 (D58)</p>	<p>TempoGate® smart assistant for Temposonics® R-Series V Part no. TG-C-0-Dxx (xx indicates the number of R-Series V sensors that can be connected (even numbers only))</p>
<p>Material: PUR jacket; gray Features: Shielded Cable Ø: 5 mm (0.2 in.) Operating temperature: -40...+90 °C (-40...+194 °F)</p>	<p>Material: PUR jacket; black Features: Shielded Cable length: 5 m (16.4 ft) Ingress protection: IP67 (correctly fitted) Operating temperature: -25...+80 °C (-13...+176 °F)</p>	<ul style="list-style-type: none"> • Connect wirelessly via Wi-Fi enabled device or via USB with the diagnostic tool • Simple connectivity to the sensor via 24 VDC power line (permissible cable length: 30 m) • User friendly interface for mobile devices and desktop computers • See data sheet “TempoLink® smart assistant” (document part no.: 552070) for further information 	<ul style="list-style-type: none"> • OPC UA server for diagnostics of the R-Series V • For installation in the control cabinet • Connection via LAN and Wi-Fi • See data sheet “TempoGate® smart assistant” document part no.: 552110 for further information

Color of connectors and cable jacket may change. Colors of the cores and technical properties remain unchanged.

ORDER CODE

1	2	3	4	5	6	7	8	9	10	11	12	13	14	15	16	17	18	19	20
R	D	V										D	5		1	U	1		1
a			b	c	d						e	f			g	h			

a	Design
R D V	Detached sensor electronics "Classic"

b	Design
C	Threaded flange M18×1.5-6g (A/F 46)
D	Threaded flange ¾"-16 UNF-3A (A/F 46)
M	Threaded flange M18×1.5-6g (A/F 24)
S	Pressure fit flange Ø 26.9 mm f6
T	Threaded flange ¾"-16 UNF-3A (A/F 23)

c	Mechanical options
For side cable entry	
A	PUR cable with M16 connector, 250 mm length
B	PUR cable with M16 connector, 400 mm length
C	PUR cable with M16 connector, 600 mm length
For bottom cable entry	
2	Single wires with flat connector, 65 mm length
4	Single wires with flat connector, 170 mm length
5	Single wires with flat connector, 230 mm length
6	Single wires with flat connector, 350 mm length

d	Stroke length
X X X X M	Flange »S«: 0025...2540 mm Flange »C«, »D«, »M«, »T«: 0025...5080 mm
Stroke length (mm)	Ordering steps
25... 500 mm	5 mm
500... 750 mm	10 mm
750... 1000 mm	25 mm
1000... 2500 mm	50 mm
2500... 5080 mm	100 mm
X X X X U	Flange »S«: 001.0...100.0 in. Flange »C«, »D«, »M«, »T«: 001.0...200.0 in.
Stroke length (in.)	Ordering steps
1... 20 in.	0.2 in.
20... 30 in.	0.4 in.
30... 40 in.	1.0 in.
40... 100 in.	2.0 in.
100... 200 in.	4.0 in.
Non standard stroke lengths are available; must be encoded in 5 mm/0.1 in. increments	

e	Number of magnets
X X	01...30 position(s) (1...30 magnet(s))

f	Connection type
D 5 6	2 × M12 female connectors (D-coded), 1 × M8 male connector
D 5 8	2 × M12 female connectors (D-coded), 1 × M12 male connector (A-coded)

g	System
1	Standard

h	Output
U 1 0 1	EtherCAT®, position, velocity and acceleration (1...30 magnet(s))
U 1 1 1	EtherCAT®, position, velocity and acceleration internal linearization (1...30 magnet(s))

NOTICE
<ul style="list-style-type: none"> Specify number of magnets for your application and order the magnets separately. The number of magnets is limited by the stroke length. The minimum allowed distance between magnets (i.e. front face of one to the front face of the next one) is 75 mm (3 in.). Use magnets of the same type for multi-position measurement. If the option for internal linearization (U111) in h "Output" is chosen, select a suitable magnet.

DELIVERY

	RDV-C/-D/-M/-T: Sensor, O-ring	Accessories have to be ordered separately.
	RDV-S: Sensor, O-ring, back-up ring	

Manuals, Software & 3D Models available at:
www.temposonics.com

GLOSSARY

D

Distributed Clock

EtherCAT® uses a logical network of **Distributed Clocks (DC)** to synchronize the time on all local bus devices on the network. The EtherCAT® master usually selects the first Distributed Clock capable slave device as a Reference Clock, and then maintains a precise mapping of frame delays for all other slave devices in order to adjust their time to match the system time.

E

ESI

The properties and functions of an EtherCAT® device are described in an ESI file (**EtherCAT® Slave Information**). The XML-based ESI file contains all relevant data that are important for the implementation of the device in the controller as well as for data exchange during operation. The ESI file of the R-Series V EtherCAT® is available on the homepage www.temposonics.com.

EtherCAT®

EtherCAT® (**Ethernet for Control Automation Technology**) is an Industrial Ethernet interface and is managed by the **EtherCAT® Technology Group (ETG)**. The R-Series V EtherCAT® and its corresponding ESI file are certified by the ETG.

Extrapolation

The native measurement cycle time of a sensor increases with the stroke length. With extrapolation, the sensor is able to report data faster than the native cycle time, independent of the stroke length of the sensor. Without extrapolation, if data is requested faster than the native cycle time, the last measured value is repeated.

I

Internal Linearization

The internal linearization offers an improved linearity for an overall higher accuracy of the position measurement. The internal linearization is set for the sensor during production.

M

Multi-position measurement

During the measurement cycle, the positions of every magnet on the sensor are simultaneously reported. The velocity and acceleration are continuously calculated based on these changing position values as the magnets are moved.

UNITED STATES
Temposonics, LLC
Americas & APAC Region
3001 Sheldon Drive
Cary, N.C. 27513
Phone: +1 919 677-0100
E-mail: info.us@temposonics.com

GERMANY
Temposonics
GmbH & Co. KG
EMEA Region & India
Auf dem Schüffel 9
58513 Lüdenscheid
Phone: +49 2351 9587-0
E-mail: info.de@temposonics.com

ITALY
Branch Office
Phone: +39 030 988 3819
E-mail: info.it@temposonics.com

FRANCE
Branch Office
Phone: +33 6 14 060 728
E-mail: info.fr@temposonics.com

UK
Branch Office
Phone: +44 79 21 83 05 86
E-mail: info.uk@temposonics.com

SCANDINAVIA
Branch Office
Phone: +46 70 29 91 281
E-mail: info.sca@temposonics.com

CHINA
Branch Office
Phone: +86 21 3405 7850
E-mail: info.cn@temposonics.com

JAPAN
Branch Office
Phone: +81 3 6416 1063
E-mail: info.jp@temposonics.com

Document Part Number:
552136 Revision B (EN) 08/2023



temposonics.com