

# Temposonics®

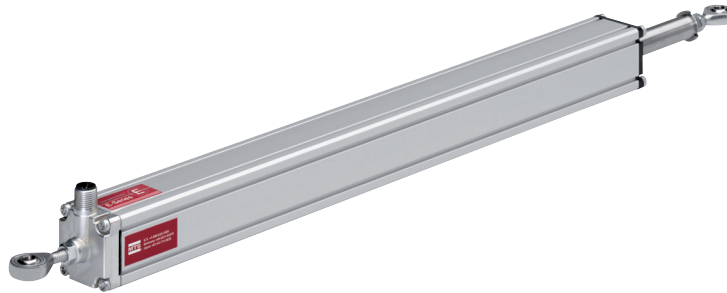
Magnetostrictive, Absolute, Non-contact  
Linear-Position Sensors



**E-Series Model ER**  
Analog and Start/Stop Outputs

Document Part Number:  
550996 Revision E

## Data Sheet



**Model ER position sensor-  
Stroke Length: 50 mm to 1500 mm (2 in. to 60 in.)**

### FEATURES

- Linear, Absolute Measurement
- Non-Contact Sensing Technology
- Linearity Deviation Less Than 0.02% F.S.
- Repeatability Within 0.005% F.S.
- Two Outputs Available:
  - Analog (Voltage/Current) Forward or Reverse Acting
  - Digital-Pulse Output (Start/Stop)
- Simple Sensor Parameter Upload (for Start/Stop)
- Stroke Length Range: 50 mm to 1500 mm (2 in. to 60 in.)
- Internal Electronics are Sealed for IP67 Ingress Protection
- EMI Shielded and CE Certified

### BENEFITS

- Rugged, Cost Effective, Precise and Durable Non-wear Alternative to Linear Potentiometers
- Extendable and Retractable Dual Rod Ends
- The Magnet is Contained and Protected Inside The Sensor Housing
- Over Voltage Protection to 36 Vdc and Polarity Protection up to -30 Vdc

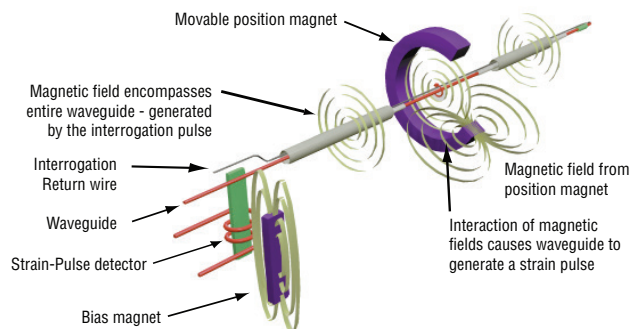
### APPLICATIONS

- Continuous Operation In Harsh Industrial Conditions

### TYPICAL INDUSTRIES

- Factory Automation
- Woodworking and Metal Forming
- Material Handling and Packaging

### Time-based Magnetostrictive position sensing principle



### Benefits of Magnetostriction

Temposonics linear-position sensors use the time-based magnetostrictive position sensing principle developed by MTS. Within the sensing element, a sonic-strain pulse is induced in a specially designed magnetostrictive waveguide by the momentary interaction of two magnetic fields. One field comes from a movable permanent magnet that passes along the outside of the sensor. The other field comes from an “interrogation” current pulse applied along the waveguide. The resulting strain pulse travels at sonic speed along the waveguide and is detected at the head of the sensing element.

The position of the magnet is determined with high precision and speed by accurately measuring the elapsed time between the application of the interrogation pulse and the arrival of the resulting strain pulse with a high-speed counter. The elapsed time measurement is directly proportional to the position of the permanent magnet and is an absolute value. Therefore, the sensor's output signal corresponds to absolute position, instead of incremental, and never requires recalibration or re-homing after a power loss. Absolute, non-contact sensing eliminates wear, and guarantees the best durability and output repeatability.

All specifications are subject to change. Contact MTS for specifications and engineering drawings that are critical to your application. Drawings contained in this document are for reference only. Go to <http://www.mtssensors.com> for the latest product documentation and related media.

## E-Series Model ER Sensor, Analog and Start/Stop Outputs

### Product Overview and Specifications

#### Product overview

MTS Sensors continues to establish new performance standards for low-cost, fully-industrial, durable position sensors using the widely preferred magnetostrictive technology. This principle for accurate and non-contact measurement of linear-position sensing was developed 30 years ago by MTS and is used with outstanding success in a large variety of industrial applications.

The innovative Temposonics model ER sensor brings proven benefits of magnetostrictive feedback to the versatile rod-and-cylinder sensor package.

It is ideal for demanding industrial applications where high performance non-contact feedback is essential for maximum productivity and overall reliability. The model ER sensor's rod-and-cylinder design has a rod that can extend from the sensor housing. As the rod is extended and retracted, the sensing magnet remains completely contained and protected at all times, ensuring reliable sensor performance in the toughest industrial environments.

#### Product specifications

Parameters	Specifications	Parameters	Specifications
<b>OUTPUT</b>		<b>ENVIRONMENTAL</b>	
<b>Measured output variables:</b>	Position	<b>Operating conditions:</b>	<b>Operating temperature:</b> -40 °C (-40 °F) to 75 °C (167 °F)
<b>Resolution:</b>	<b>Analog:</b> Infinite (restricted by output ripple) <b>Start/Stop:</b> 0.1, 0.01 and 0.005 mm (controller dependent)		<b>Relative humidity:</b> 90% no condensation
<b>Linearity deviation:</b>	< ± 0.02% full stroke (minimum ± 60 µm)		<b>Ingress protection:</b> IP 67** (when mating connector is correctly fitted)
<b>Repeatability:</b>	< ± 0.005% full stroke (minimum ± 20 µm)	<b>EMC test:</b>	<b>Electromagnetic emission:</b> EN 61000-6-4 <b>Electromagnetic susceptibility:</b> EN 61000-6-2. This sensor meets the EC directive requirements and is marked with CE.
<b>Outputs:</b>	<b>Analog (voltage or current) Voltage:</b> 0 to 10 Vdc and 10 to 0 Vdc or <b>Two outputs:</b> 0 to 10 Vdc and 10 to 0 Vdc (controller input resistance RL ≥ 5k Ohm) <b>Current:</b> 4 to 20 mA or 20 to 4 mA (Controller input resistance RL ≤ 500 Ohm)	<b>Shock rating:</b>	100 g (single hit)/ IEC standard EN 60068-2-27
	<b>Digital-pulse (Start/Stop):</b> RS-422 differential signal Serial parameter upload available for: Measuring range, offset, gradient, status and manufacturer number	<b>Vibration rating:</b>	10 g/10 to 2000 Hz, IEC standard EN 60068-2-6 (resonance frequencies excluded)
<b>Stroke length:</b>	<b>Range:</b> 50 mm to 1500 mm (2 in. to 60 in.)	<b>WIRING</b>	
<b>ELECTRONICS</b>		<b>Connection types:</b>	<b>Analog output:</b> 5-pin (M12) male integral connector <b>Start/Stop output:</b> 8-pin (M12) male integral connector
<b>Operating voltage:</b>	<b>+24 Vdc nominal:</b> -15% or +20%* <b>Polarity protection:</b> up to -30 Vdc <b>Over voltage protection:</b> up to 36 Vdc <b>Current drain:</b> Analog: 50 - 140 mA Start/Stop: 50 - 100 mA (Stroke length dependent) <b>Dielectric withstand voltage:</b> 500 Vdc (DC ground to machine ground)	<b>ROD-AND-CYLINDER STYLE SENSOR</b>	
		<b>Sensor rod:</b>	Aluminum
		<b>Sensor housing:</b>	Aluminum
		<b>Mounting options:</b>	Adjustable mounting clamps or dual rod ends

\* UL Recognition requires an approved power supply with energy limitation UL 61010-1), or Class 2 rating according to the National Electrical Code (USA) / Canadian Electrical Code.

\*\* The IP rating is not part of the UL Recognition.

## Outputs

### ANALOG (VOLTAGE/CURRENT) OUTPUTS

Analog outputs include voltage (0 to 10 Vdc forward or reverse acting), and current (4 to 20 mA forward or reverse acting). Since the outputs are direct, no signal conditioning electronics are needed when interfacing with controllers or meters (see 'Figure 1').

#### Analog output voltages ranges:

- 0 to 10 Vdc
- 10 to 0 Vdc
- 0 to 10 Vdc and 10 to 0 Vdc
- 4 to 20 mA
- 20 to 4 mA

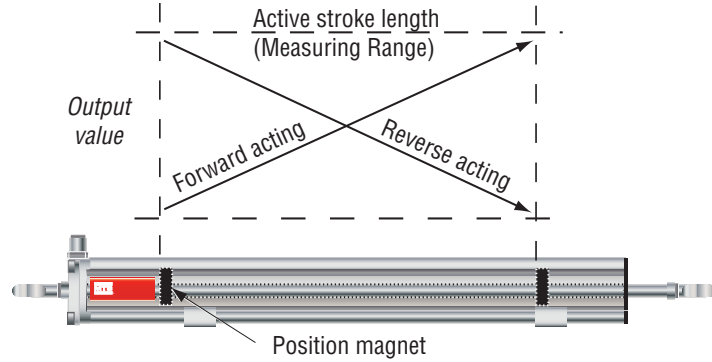


Figure 1. Analog Output signals

### DIGITAL START/STOP OUTPUT

The Temposonics E-Series Model ER Start/Stop output sensors require a start signal from a controller or interface module to initiate the measurement cycle. The sensor generates a stop signal at the end of the measurement cycle that is used to stop the controller's counter clock.

The elapsed time between the Start and Stop signals is directly proportional to the magnet's position along the active stroke length. The controller can calculate the absolute position of the magnet from the time value and the sensor's unique gradient value (inverse of the speed for the sonic pulse traveling in the sensor's waveguide). (see 'Figure 2').

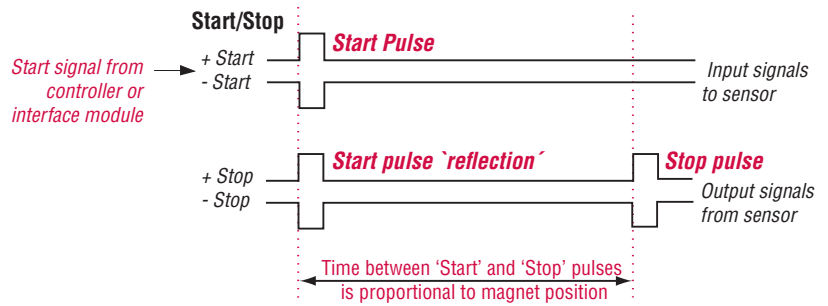


Figure 2. Start/Stop output signals (RS-422 differential pairs)

## Communication

### SENSOR PARAMETER UPLOAD FEATURE

For applications using smart sensor interfaces, the Model ER sensor with Start/Stop output (Option R3) comes with the ability to perform sensor parameter uploads. This feature replaces the task of entering sensor data manually, saving time and preventing possible entry errors during start-up or for system maintenance.

#### Note: Start/Stop output (option R3)

When the sensor parameter upload feature is not activated the Start/Stop output (Option R3) remains fully compatible with the Start/Stop output (Option R0) used in the previous generation E-Series sensor family.

#### The upload feature supports the following sensor parameters:

- Measuring range
- Offset
- Gradient - (Shown as speed of the sonic-strain pulse (m/s) or inverse speed (µs/in.))
- Status
- Manufacturer number

The sensor's specific parameters can be retrieved by the controller and interface module at any time, via the sensor's Start/Stop signal lines.

The sensor parameter upload feature requires a customer supplied RS-422 interface. The data format is serial, 4800 Baud, 8-bit data length. Please contact the factory for additional parameter upload protocol details.

## E-Series Model ER Sensor, Analog and Start/Stop Outputs Sensor Dimensions and Mounting

### Model ER rod-and-cylinder sensor dimension references

Drawings are for reference only, contact applications engineering for tolerance specific information.

A robust aluminum extrusion forms the sensor housing containing the sensor rod, magnet, sensing element and electronics. The permanent magnet is mounted on a sliding carrier attached to the end of the rod. As the rod moves in and out, the magnet travels above the sensing element inside the sensor housing.

#### MODEL ER ROD-AND-CYLINDER SENSOR

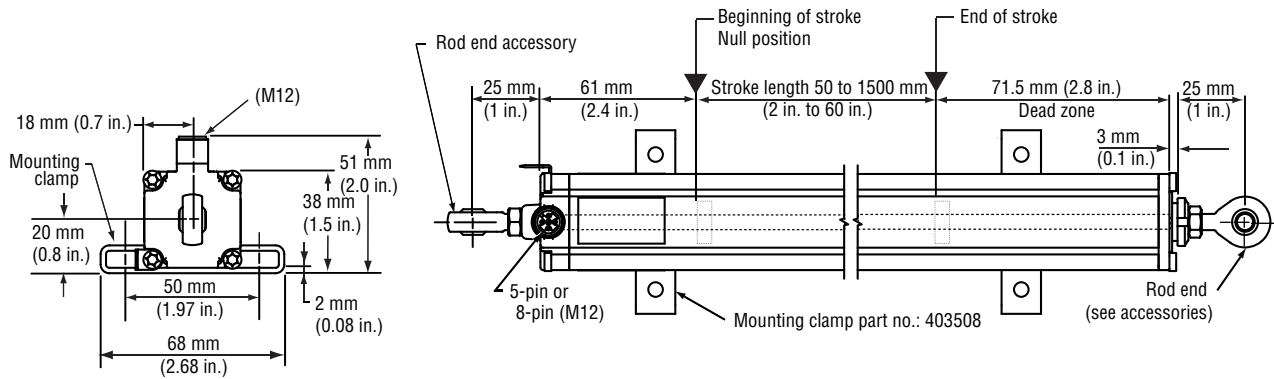


Figure 3. E-Series model ER rod-and cylinder sensor dimension reference

### Sensor mounting (Model ER)


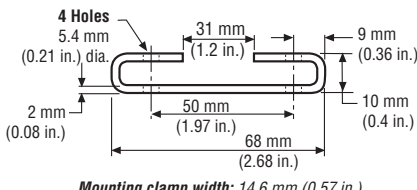
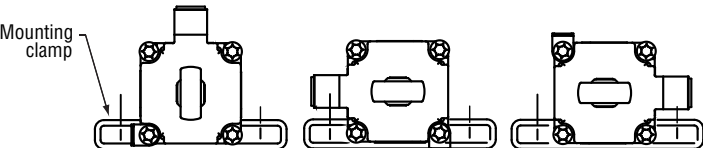
#### SENSOR MOUNTING CLAMPS

The E-Series model ER sensor is mounted onto the machine with moveable mounting clamps. Grooves for mounting clamps are available on three sides of the sensor housing, allowing versatile mounting orientations for the sensor's connector and extension cable. The rod is then attached to the moving machine part.


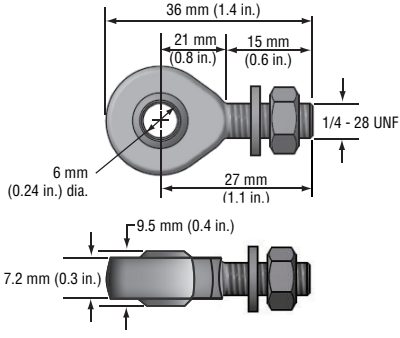

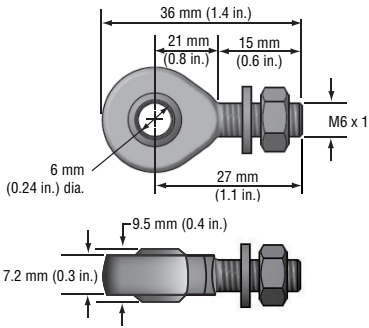

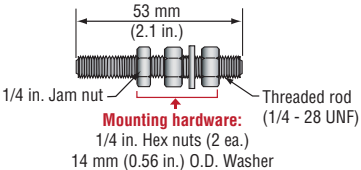
Optional rod ends can be used to simplify sensor installation design and facilitate articulated motion sensing. Using dual rod ends the model ER sensor can be mounted between two independent moving points, such as swinging door applications. Please note for model ER sensors having stroke lengths over 750 mm (30 in.) only the first 90% of the stroke length can be used for articulated type applications when the weight of the sensor is supported only by rod ends.

#### Notes:

1. Mounting clamps are ordered separately. Two mounting clamps, (part number 403508) are required for stroke lengths up to 750 mm (30 in.). A least one additional mounting clamp is required for longer stroke lengths.
2. MTS recommends using 10-32 cap screws (customer supplied) at a maximum torque of 44 in. lbs. when fastening mounting clamps.

Model ER sensor mounting and installation reference	Mounting method	Part number
 	<b>Mounting clamp</b> Sensor mounting for sensor model ER	403508
	<b>Three possible mounting configuration using mounting clamp and screws</b>	Mounting clamp, part number 403508

## E-Series Model ER Sensor, Analog and Start/Stop Outputs Sensor Mounting

Model ER sensor mounting and installation reference	Mounting method	Part number
 	<p><b>Rod end</b> US customary measurement Optional, male 1/4 - 28 threads</p>	<p>254235</p>
 	<p><b>Rod end</b> Metric measurement Optional, male M6 threads</p>	<p>254210</p>
  <p><b>Mounting hardware:</b> 1/4 in. Hex nuts (2 ea.) 14 mm (0.56 in.) O.D. Washer</p>	<p><b>Stud end</b> Optional mounting hardware kit Hex nuts (2 pcs.), jam nut and washer</p>	<p>251975</p>

## E-Series Model ER Sensor, Analog and Start/Stop Outputs Connections and Wiring

### Connections and wiring (Model ER)

#### SENSOR INTEGRAL CONNECTOR (D34 AND D84) PINOUT/WIRE COLOR CODES

The E-Series model ER sensor connects directly to a controller or interface module with the standard male, 5-pin or 8-pin integral connector and an extension cable as described in 'Table 1' and 'Table 2' below.

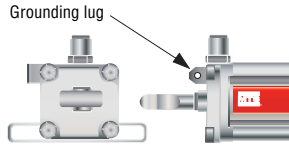


Figure 4. Grounding lug location.

#### Attention:

The sensors aluminum housing has an anodic coating which prevents the sensor's mounting clamps from providing the appropriate grounding. A grounding lug (see 'Figure 4') is provided near the connector end of the sensor for a convenient connection to earth ground. The appropriate grounding of the cable shield is also required at the controller end.



Integral D34 connector (male) as viewed from the end of the sensor

Pin no.	Extension Cable Wire color	Signal/Function Analog outputs
1	Brown	+24 Vdc
2	White	Output signal
3	Blue	DC ground (for power return)
4	Black	2nd Output signal (optional)
5	Gray	Ground for signal return

Table 1. Integral D34 sensor connector (mates with cable connectors 370618 and 370619)




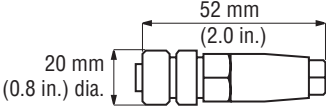

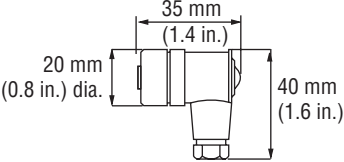
Integral D84 connector (male) as viewed from the end of the sensor

Pin no.	Extension cable wire color	Signal/function Start/Stop outputs
1	White	(+) Start
2	Brown	(-) Start
3	Green	(+) Stop
4	Yellow	(-) Stop
5	Gray	No connection
6	Pink	No connection
7	Blue	+24 Vdc
8	Red	DC ground (for power return)


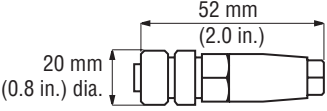

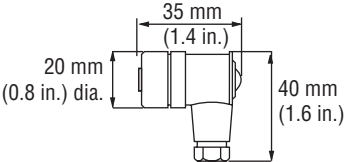
Table 2. Integral D84 sensor connector (mates with cable connectors 370671 and 370672)

## E-Series Model ER Sensor, Analog and Start/Stop Outputs Cable Connector Options (D34 and D84)

### MATING CABLE CONNECTOR OPTIONS FOR (D34) CONNECTOR TYPES *(Photo and drawing dimensions are for reference only)*

Connector and dimensions	Description	Part number
 	<p>Female cable connector, straight exit (Field installable) 5-Pin (D34) Mates with standard male (M12) integral connector <b>Termination:</b> Screw terminals <b>Cable gland:</b> PG9 for 6-8 mm dia. cable <b>Ingress protection:</b> IP67</p>	370618
 	<p><b>Female cable connector, 90° exit (Field installable)</b> 5-Pin (D34) Mates with standard male (M12) integral connector <b>Termination:</b> Screw terminals <b>Cable gland:</b> PG9 for 6-8 mm dia. cable <b>Ingress protection:</b> IP67</p>	370619


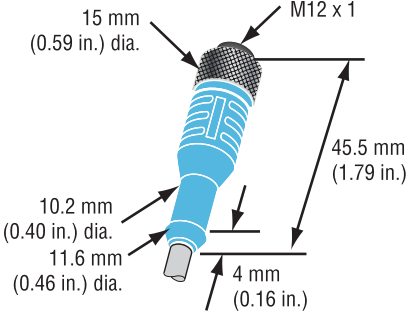
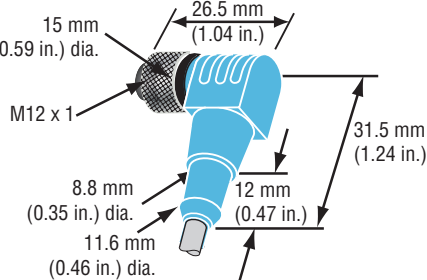

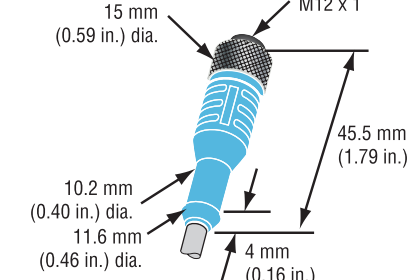
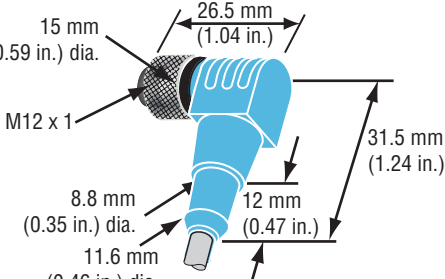
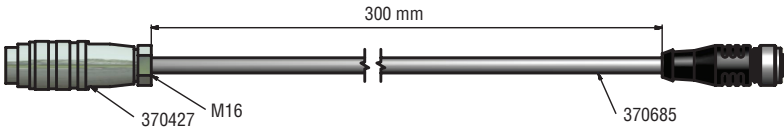
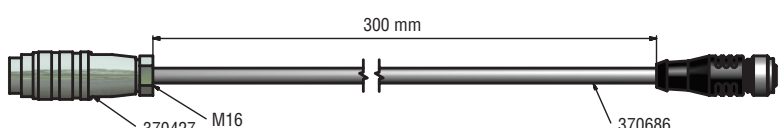
### MATING CABLE CONNECTOR OPTIONS FOR (D84) CONNECTOR TYPES *(Photo and drawing dimensions are for reference only)*

Connector and dimensions	Description	Part number
 	<p>Female cable connector, straight exit (Field installable) 8-Pin (D84) Mates with standard male (M12) integral connector <b>Termination:</b> Screw terminals <b>Cable gland:</b> PG9 for 6-8 mm dia. cable <b>Ingress protection:</b> IP67</p>	370671
 	<p><b>Female cable connector, 90° exit (Field installable)</b> 8-Pin (D84) Mates with standard male (M12) integral connector <b>Termination:</b> Screw terminals <b>Cable gland:</b> PG9 for 6-8 mm dia. cable <b>Ingress protection:</b> IP67</p>	370672



**E-Series Model ER Sensor, Analog and Start/Stop Outputs**  
**M12 Cord Sets and Adapter Cable Options**

**M12 CORD SETS AND (M16) ADAPTER CABLE OPTIONS** (Photo and drawing dimensions are for reference only)

Cord set and dimensions	Description	Part number
 	<p><b>M12 Cord set, female connector, Straight exit</b>                      5-Pin (M12) mates with standard male (D34) integral connector  <b>Ingress protection: IP67</b>  <b>Cable: 5 m, shielded, pigtail end</b></p>	370673
<p>(Image not available)</p> 	<p><b>M12 Cord set, female connector 90° exit</b>                      5-Pin (M12) mates with standard male (D34) integral connector  <b>Ingress protection: IP67</b>  <b>Cable: 5 m, shielded, pigtail end</b></p>	370675
 	<p><b>M12 Cord set, female connector, straight exit</b>                      8-Pin (M12) mates with standard male (D84) integral connector  <b>Ingress protection: IP67</b>  <b>Cable: 5 m, shielded, pigtail end</b></p>	370674
<p>(Image not available)</p> 	<p><b>M12 Cord set, Female, Connector 90° Exit</b>                      8-Pin (M12) mates with standard male (D84) integral connector  <b>Ingress protection: IP67</b>  <b>Cable: 5 m, shielded, pigtail end</b></p>	370676
Adapter cable and dimensions	Description	Part number
	<p><b>Adapter cable</b>                      5-Pin female (M12) connector, straight exit to 6-pin male D60 (M16) connector, straight exit  <b>Ingress protection: IP67</b></p>	254257
	<p><b>Adapter cable</b>                      8-Pin female (M12) connector, straight exit to 6-pin male D60 (M16) connector, straight exit  <b>Ingress protection: IP67</b></p>	254258



## E-Series Model ER Sensor, Analog and Start/Stop Outputs Ordering Information

Use the order matrix below to configure your Model ER sensor order number.

E	R														
1	2	3	4	5	6	7	8	9	10	11	12	13	14	15	

- SENSOR MODEL** \_\_\_\_\_ = E R **1 - 2**
- ER** = E-Series model ER position sensor
- HOUSING STYLE** \_\_\_\_\_ =  **3**
- S** = Inside thread 1/4 - 28 at end of rod (For model ER sensors using US customary stroke length measurement)
- M** = Inside thread M6 at end of rod ( For model ER sensors using metric stroke length measurement)
- STROKE LENGTH** \_\_\_\_\_ =      **4 - 8**
- \_\_\_\_\_ **M** = Millimeters (Encode in 25 or 50 mm increments) as indicated in 'Stroke length notes' below.
- \_\_\_\_\_ **U** = Inches (Encode in 1 or 2 in. increments) as indicated in 'Stroke length notes' below.  
(Digit for tenths of inches is always '0')

Stroke length Notes:	
<b>Stroke length ranges:</b>	
<b>M</b> = 50 to 1500 mm (Preferred stroke lengths are: 75,100, 150, 200, 300, 400, 500, 600, 750, 1000 and 1250 mm)	
<b>U</b> = 2 to 60 in. (Preferred stroke lengths are: 3, 6, 9, 12, 15, 18, 21, 24, 30, 42, 48 and 54 in.)	
<b>The increment size between standard stroke lengths vary as shown below:</b>	
Stroke length (mm)	Ordering increment
≤ 500 mm	25 mm
> 500 mm and ≤ 1500 mm	50 mm
Stroke length (IN)	Ordering increment
≤ 22 in.	1 in.
> 22 in. and ≤ 60 in.	2 in.

- SENSOR CONNECTION TYPES** \_\_\_\_\_ = D   **9 - 11**
- D34** = 5-Pin (M12), male, (Analog output)
- D84** = 8-Pin (M12), male, (Start/Stop output)
- INPUT VOLTAGE** \_\_\_\_\_ = 1 **12**
- 1** = + 24 Vdc (+20%, -15%), standard
- OUTPUT** (2 or 3 digit code defined by output option selected below) \_\_\_\_\_ =    **13 - 15**
- VOLTAGE**
- V01** = 0 to 10 Vdc
- V11** = 10 to 0 Vdc
- V03** = 0 to 10 Vdc and 10 to 0 Vdc (2 output channels)
- CURRENT**
- A01** = 4 to 20 mA
- A11** = 20 to 4 mA
- START/STOP**
- R3** = Start/Stop with sensor parameters upload function
- Start/Stop output (Option **R3**) is fully compatible with the Start/Stop output (Option **RO**) used in the previous generation E-Series sensors.

**Document Part number:**  
550996 Revision E (EN) 05/2014



## LOCATIONS

**USA**  
**MTS Systems Corporation**  
**Sensors Division**  
3001 Sheldon Drive  
Cary, N.C. 27513, USA  
Tel. +1 919 677-0100  
Fax +1 919 677-0200  
info.us@mtssensors.com  
www.mtssensors.com

**GERMANY**  
**MTS Sensor Technologie**  
**GmbH & Co. KG**  
Auf dem Schüffel 9  
58513 Lüdenscheid, Germany  
Tel. +49 2351 9587-0  
Fax +49 2351 56491  
info.de@mtssensors.com  
www.mtssensor.de

**JAPAN**  
**MTS Sensors Technology Corp.**  
737 Aihara-machi,  
Machida-shi,  
Tokyo 194-0211, Japan  
Tel. +81 42 775-3838  
Fax +81 42 775-5512  
info.jp@mtssensors.com  
www.mtssensor.co.jp

**FRANCE**  
**MTS Systems SAS**  
Zone EUROPARC Bâtiment EXA 16  
16/18, rue Eugène Dupuis  
94046 Creteil, France  
Tel. +33 1 58 4390-28  
Fax +33 1 58 4390-03  
info.fr@mtssensors.com  
www.mtssensor.com

**ITALY**  
**MTS Systems Srl. Sensor Division**  
Via Diaz,4  
25050 Provaglio d'Iseo (BS), Italy  
Tel. +39 030 988 3819  
Fax +39 030 982 3359  
info.it@mtssensors.com  
www.mtssensor.com

**CHINA**  
**MTS Sensors**  
Room 504, Huajing Commercial Center,  
No. 188, North Qinzhou Road  
200233 Shanghai, China  
Tel. +86 21 6485 5800  
Fax +86 21 6495 6329  
info.cn@mtssensors.com  
www.mtssensors.cn

## LEGAL NOTICES

MTS, Temposonics and Level Plus are registered trademarks of MTS Systems Corporation. All other trademarks are the property of their respective owners. Printed in USA. Copyright © 2014 MTS Systems Corporation. All Rights Reserved in all media.

All specifications are subject to change. Contact MTS for specifications and engineering drawings that are critical to your application. Drawings contained in this document are for reference only. Go to <http://www.mtssensors.com> for the latest product information.