

Temposonics®

Absolute, Non-Contact Position Sensors

R-Series Catalog

0.5 μm

Analog
CANbus
Profibus-DP
SSI
EtherCAT
Profinet

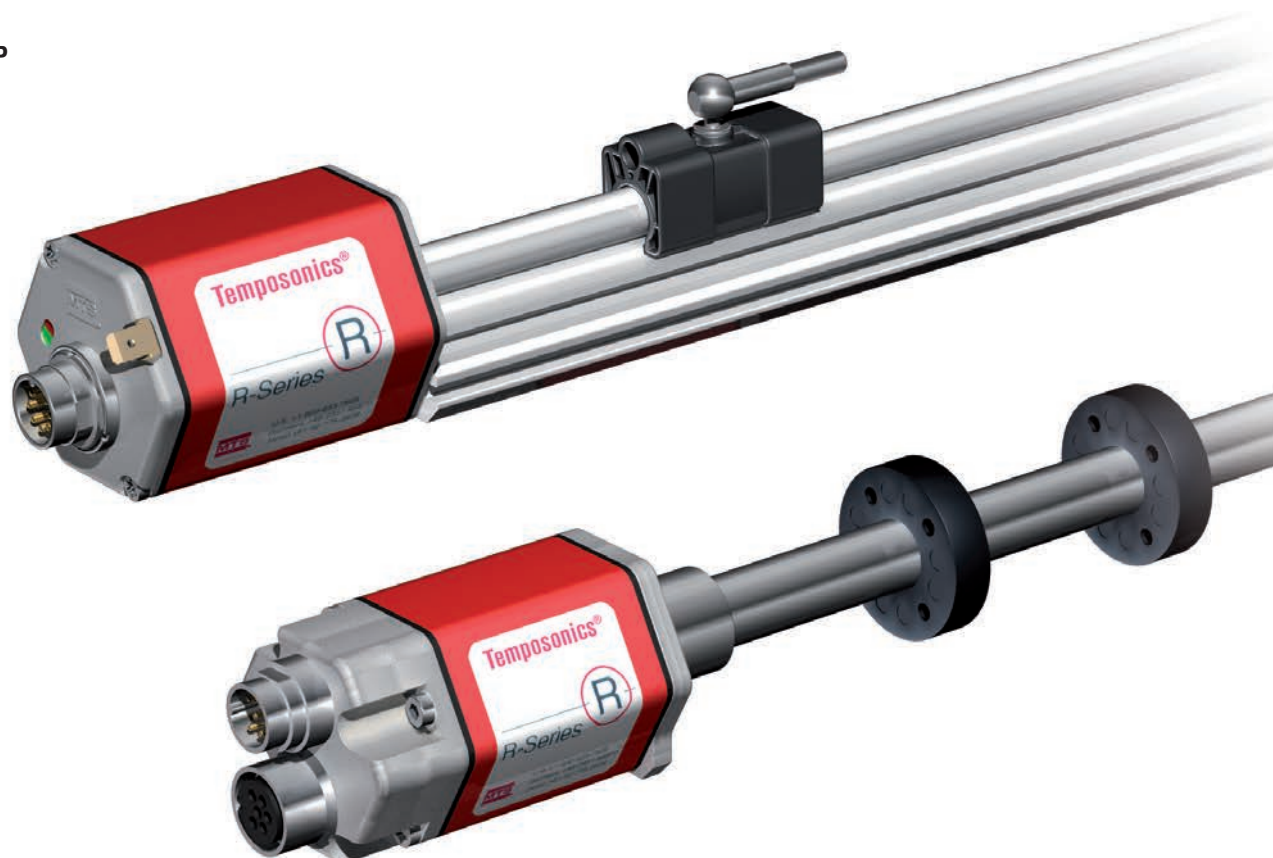

The Measurable Difference

Contents

Company	3
Principle	4
Applications	5
Quality	6 - 7
Glossary	8
General Data	9
R-Series Analog	11 - 16
R-Series CANbus	17 - 22
R-Series EtherCAT	23 - 28
R-Series Profibus-DP	29 - 34
R-Series Profinet	35 - 40
R-Series SSI	41 - 46
Mounting / Installation RP + RH	47
R-Series Flexibel	49 - 53
R-Series RD4	55 - 62
R-Series RS	63 - 66
Accessories	67 - 81
Service	82

THE COMPANY

The World of MTS

Following the founding of **MTS Systems Corporation** in 1951, the company rapidly developed into a leading supplier of intelligent hardware and software products in the fields of test and simulation systems and in measuring and automation technology. Today MTS Systems Corporation has over **2.200 employees** worldwide – **360** of whom are employed by **MTS Sensors** at three sites in the **USA (Cary, N.C.)**, **Germany (Lüdenscheid)** and **Japan (Tokyo)**. At MTS, intensive basic research is efficiently merged with a consistent focus on practical requirements. The results are innovative solutions for a wide range of potential industrial and non-industrial applications.



Headquarters
MTS Systems Corporation, Minneapolis, USA



MTS Sensor Technologie
Lüdenscheid, Germany



MTS Sensors Division
Cary (North Carolina), USA



MTS Sensors Technology Corp.
Tokyo, Japan

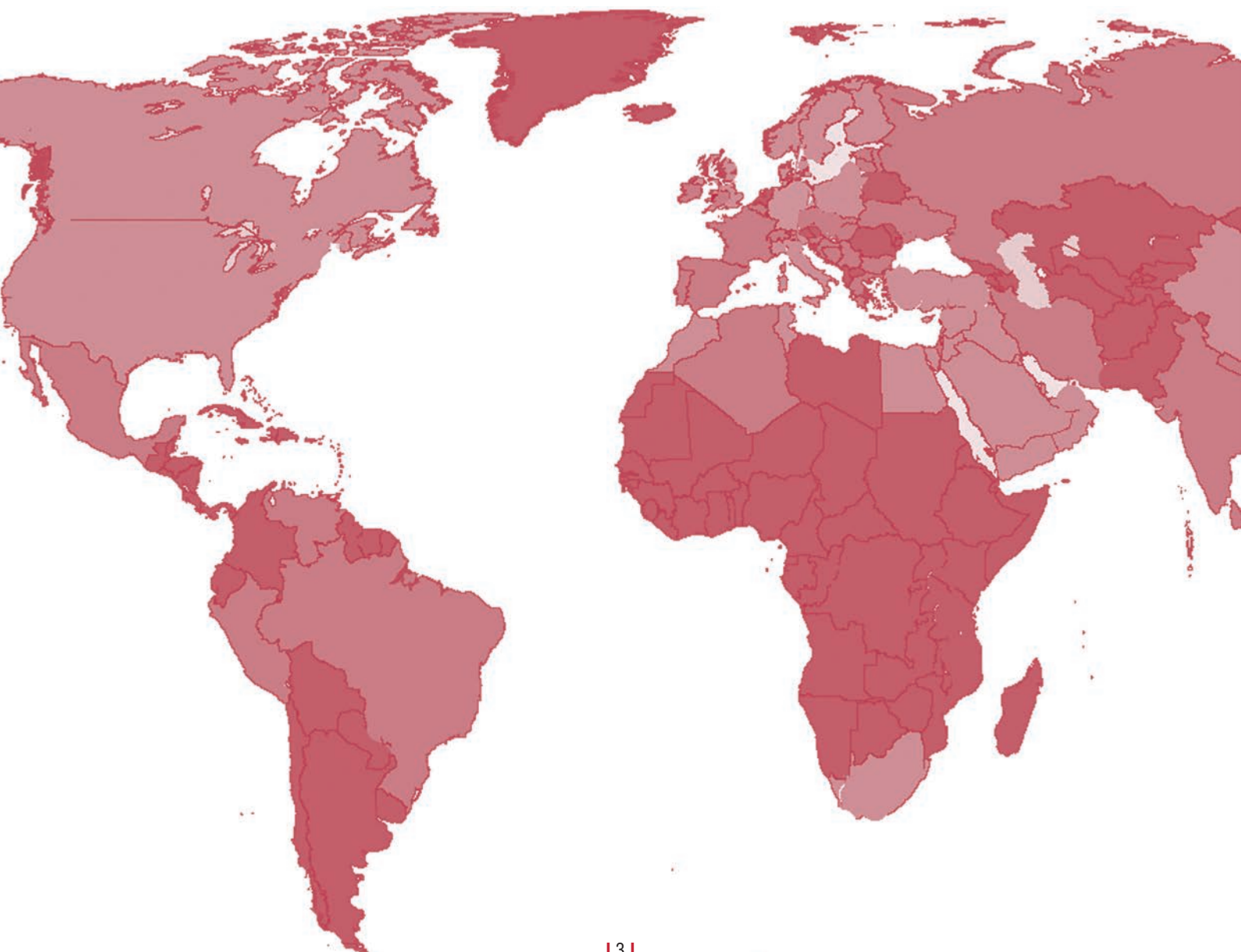

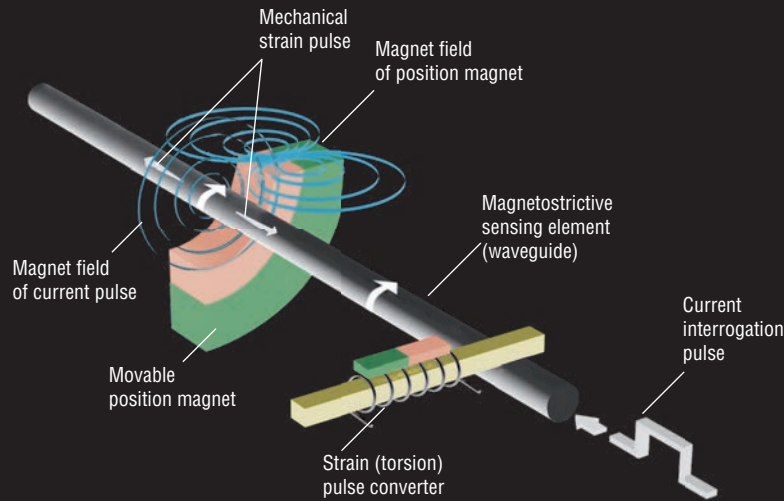

MAGNETOSTRICTIVE PRINCIPLE

Technology at its best

The best linear position sensors provide absolute position measurement resulting in higher productivity and greater safety for machine and automation devices. MTS linear position sensors outperform the competition, deliver accuracy and reliability under the most difficult conditions, resulting in excellent value for our customers. Our success is due to more than 30 years of technology leadership, vertically integrated manufacturing processes and unsurpassed levels of support.

MTS Sensors was the first to realize the promising advantages for linear position measurement contained in the magnetostrictive measuring principle developed by J. Tellermann. Tellerman's original design, was used to develop Temposonics® brand sensors: the first magnetostrictive position sensors, a technology which guarantees precision and reliability without equal.

Magnetostriction - how it works

The heart of MTS sensors is the ferromagnetic measuring element, also known as the waveguide, and a movable position magnet that generates a direct-axis magnetic field in the waveguide.

When a current or interrogation pulse passes through the waveguide, a second magnetic field is created radially around the waveguide. The interaction between the magnetic field in the waveguide and the magnetic field produced by the position magnet generates a strain pulse which travels at a constant ultrasonic speed from its point of generation, the measurement point, to the end of the waveguide where it is transformed into an electric pulse in the sensor element. The resulting signal is processed by the specialized electronics of the Temposonics® sensor. With our extensive know-how of ferromagnetic materials, magnetic effects and ultrasonic processes, MTS remains unrivalled in performance standards for non-contacting position measurement of the highest precision.

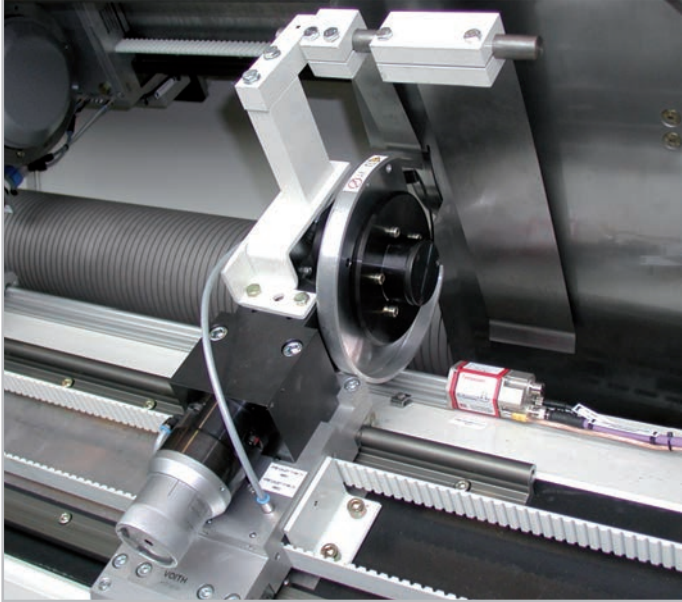

APPLICATIONS

Magnetostriction: The best choice for your application

You are under constant pressure to improve your products, reduce your costs and maintain a competitive edge. The choice you make must provide accuracy and repeatability. You need modular solutions that can adapt to your specific application and you need a price/performance ratio that delivers value. By choosing MTS Temposonics® sensors, you're choosing the leader in magnetostrictive sensors.

And that means you have a huge competitive advantage.

Increased productivity through innovation

MTS sensors do more than just measure position. Intelligent electronics move some control functions to the sensor, dramatically increasing productivity. When needed, MTS can tailor application-specific software to meet your needs.

Small sensor - great effect

MTS Temposonics® position sensors are used in countless industrial and non-industrial applications, from packaging machines through drinks bottling and canning plants right up to plastics molding machines and steel rolling mills. The precision and reliability of Temposonics® sensors offer huge benefits that result in high-quality products and efficient processes.

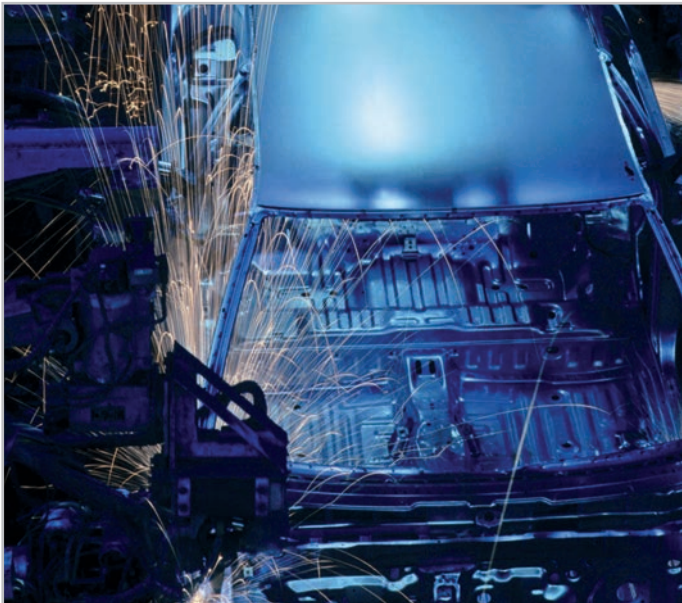

Amazing, where Temposonics® can be found....

Temposonics® sensors are often found wherever position must be measured precisely. Our engineers love the challenges of unusual applications, and they have helped customers to solve many difficult applications around the world. In the truest sense of the word, Temposonics® paved the way for the planning of the bridge over the Great Belt in the Baltic Sea and the Veltins-Arena in Gelsenkirchen (Germany). Temposonics® sensors also helped in the salvage of the capsized Russian submarine "Kursk".

Temposonics® rod-in-cylinder: thinking ahead

In order to enable user-friendly use of superior Temposonics® sensor technology in cylinders, MTS has further enhanced the rod-style version. An innovative modular design eliminates the need to break the high-pressure hydraulic seal of the fluid system when installing or replacing the sensor cartridge. The sensor's pressure housing can stay permanently mounted in the cylinder and the basic sensor can be easily removed. This capability significantly reduces maintenance costs and potential downtime.

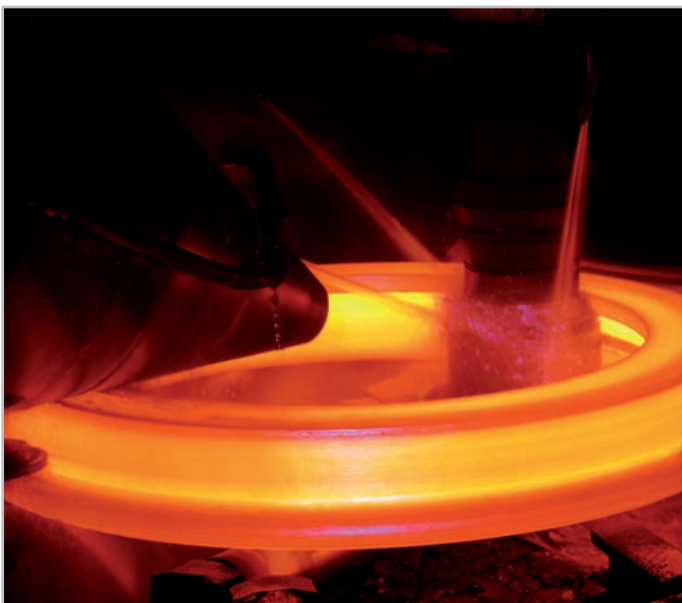

A Liquid Level sensor....

By simply mounting the position magnet into a float, the application range of R-Series sensors extends substantially. These highly precise float gauges supply exact level values. In addition, a second float can be added to measure "interface levels" simultaneously (i.e. interface of water / oil, etc.).

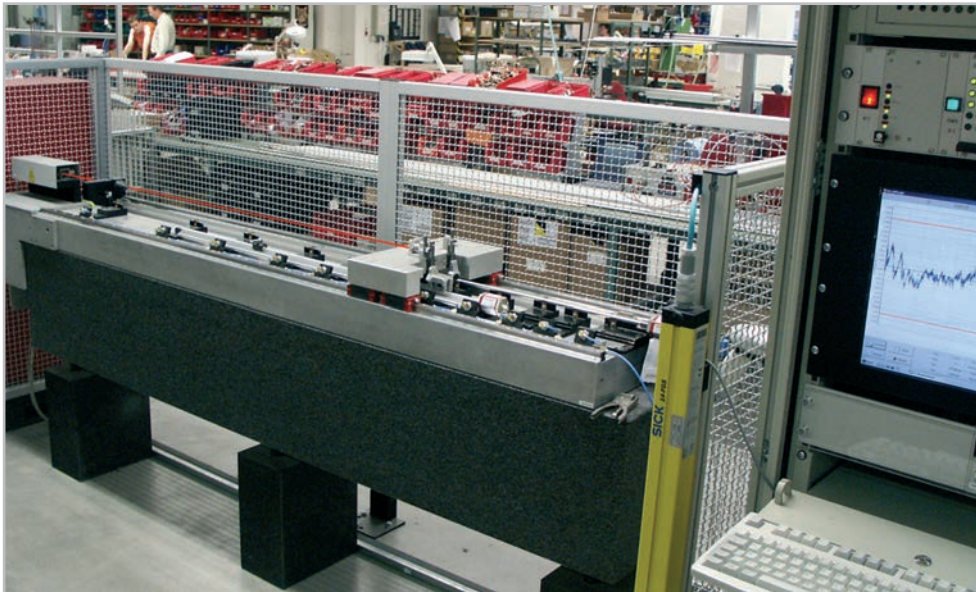

Laser controlled quality: Up to 1000 measuring points per mm!

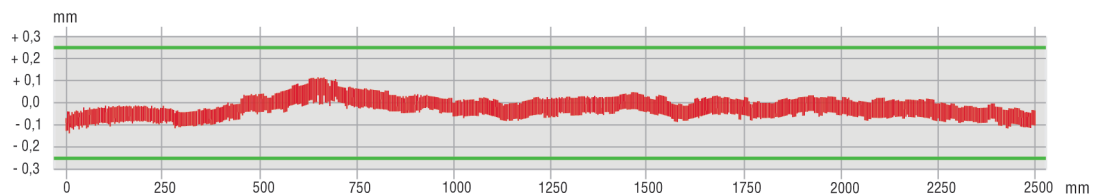

QUALITY

Precision is our strength

Maximum precision and uncompromising quality in the service of the customer - those are the characteristic elements of the MTS philosophy. Focused on these targets, MTS Sensors has been setting standards in measuring and automation technology worldwide for **three decades**. Our ultramodern, **fully automated** production technology guarantees the consistently high quality and precision of Temposonics® position sensors so that they can reliably pass our stringent quality requirements. Shock and vibration resistance and EMC tests, for example, are monitored on external test facilities and during the final inspection, each sensor passes automatic high profile laser interferometer measuring tables which examine and document linearity in up to **0.5 µm** steps.

Our engineers enthusiastically take up every challenge and develop position measuring solutions of exemplary precision based on magnetostriction, even for the most unusual applications. Over the decades, we have built up a wealth of experience which we put into practice in the form of intelligent sensors and software for our customers in a wide variety of industrial sectors. And our quality requirements extend to our comprehensive after-sales service.

QUALITY ASSURANCE

The quality of our position sensors and liquid level transducers is our mission and it is black on white certified. It proves itself in countless applications world-wide every day. MTS co-operates with research institutes, professional associations from the range of the sensor technology and user organizations, in order to offer the customers sensors with a maximum of innovative quality.

Certificate

PROFIBUS Nutzerorganisation e.V. grants to
MTS Sensor Technologie GmbH
 Auf dem Schüffel 9, 58513 Lüdenscheld, Germany

the Certificate No: **Z01255** for the PROFIBUS device:

Model Name: MTS R-Series
Revision: 22Sep06; SW/FW: SW05; HW: HW04
GSD: MTSR04C3.GSG, File Version: 22.Sep.06

This certificate confirms that the product has successfully passed the certification tests with the following scope:

<input checked="" type="checkbox"/> DP-V0	MS0, Sync, Freeze, Set_Slave_Add
<input checked="" type="checkbox"/> Physical Layer	RS485

Test Report Number: **481-1**
 Authorized Test Laboratory: **Siemens AG, Fürth, Germany**

The tests were executed in accordance with the following documents:
 "Test Specifications for PROFIBUS DP Slaves, Version 3.0 from November 2005".
 This certificate is granted according to the document:
 "Framework for testing and certification of PROFIBUS and PROFINET products".
 For all products that are placed in circulation by March 14, 2013 the certificate is valid for life.

[Signature]
 (Official in Charge)

Board of PROFIBUS Nutzerorganisation e. V.

[Signature]
 (Jörg Freitag)

[Signature]
 (K.-P. Lindner)

CERTIFICATE

This is to certify that

MTS Sensor Technologie GmbH & Co. KG
 Auf dem Schüffel 9
 58513 Lüdenscheld

has implemented and maintains a **Quality Management System**.

Scopes:
 Development and manufacturing of linear position transducers and liquid level measuring systems based on the magnetostrictive principle

Through an audit, documented in a report, it was verified that the management system fulfills the requirements of the following standard:

ISO 9001 : 2008

Certificate registration no. 003095 QM08
 Date of certification 2013-02-20
 Valid until 2016-02-19

DQS GmbH
Götz Blechschmidt
 Götz Blechschmidt
 Managing Director

Accredited Body: DQS GmbH, August-Schanz-Straße 21, 60433 Frankfurt am Main



GLOSSARY

A

Absolute position

The sensor's output indicates the position relatively to an absolute (fixed) reference point. Immediately after power is applied, there is no need to 'rehome' the sensor as you would with one that provides an incremental position output.

Asynchronous mode

Asynchronous data communication occurs when data is sent from one device with its own clock to another device with a separate clock. When the Temposonics® R-Series SSI position sensor is used in the asynchronous mode, the sensor takes measurements at its fastest internal interrogation rate (length dependent) and provides the information upon request.

D

Drift

see also warm-up and temperature coefficient.
Drift is the change in the output signal or output value under environmental impact e.g. time or temperature.

F

Full Scale (F.S.)

(see range)

G

Gradient

The gradient is the inverse of the rate at which a strain pulse propagates through the magnetostrictive waveguide. (velocity of propagation ≈ 2780 m/s). The gradient values will vary slightly from sensor to sensor. The actual measured gradient values for some sensors are indicated on the label attached to the sensor.

H

Hysteresis

The difference in indicated position for the same point along a stroke length when reached from **opposing directions**.

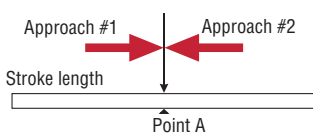

Note: The hysteresis specification for Temposonics® position sensors is minimal and can be ignored, in most applications.

L

Load impedance

The impedance presented to the output terminals of a transducer by the associated external circuitry.

M

Multi-position measurement

Multiple magnets located at several positions along the stroke can be used to measure multiple positions simultaneously. MTS Temposonics® R-Series products can measure 20 positions on a single sensor.

N

Non-contact

MTS Temposonics® sensors utilize a non-contact sensing technology that results in longer-lasting sensors with greater reliability and no mechanical wear.

Non-linearity

The degree that the indicated position of the magnet at points along the stroke length of the sensor varies from the actual physical position. In magnetostrictive sensors, this variability is caused by minute differences in the propagation rate of the return signals through the waveguide medium. Non-linearity is expressed in absolute error or as a percentage of the active stroke length.

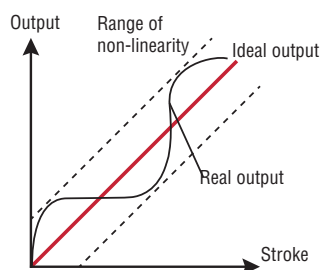

O

Outputs

1. Digitally-derived analog output: The Temposonics® R-Series product line offers a digitally-derived analog output. A digital position count of 16 bits is converted to an analog signal (voltage or current) via a digital/analog converter.

2. Digital output: The Temposonics® R-Series product line provides digital output in either a SSI, CANbus, DeviceNet®, Profibus or EtherCAT. An internal counter is used to precisely measure the time interval between the launching of an interrogation pulse and the receipt of a return signal. The time interval, detected in counts, is then supplied to the customer's interface via the chosen format or protocol above.

R

Range

The measurands, over which a sensor is intended to measure, specified by their upper and lower limits.

Repeatability

The deviation in indicated position when a point along a stroke length is approached repeatedly from the same direction. For an example, see the illustration below.

If you leave point "A" and then return to it from the same direction as before, the change in indicated position between the two readings is described by the repeatability specification. For magnetostrictive sensors, repeatability is usually equal to resolution.

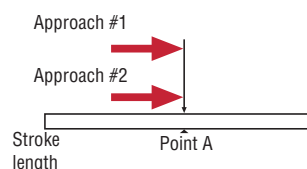

Resolution

The term resolution describes the smallest incremental change in position along the stroke length that can be detected and indicated in an output. For digital systems, such as the R-Series, resolution is a discrete value corresponding to one binary bit out of the total number of bits used in the output.

Ambient condition

Environmental conditions, under which transducers must commonly operate, which have been established as follows:

- a) temperature: 25 °C (± 10 K)
 - b) relative humidity: < 90 %
- Tolerance closer than shown are

frequently specified for transducer calibration and test environments.

T

Temperature Coefficient (TC)

Temperature Coefficient (TC) is expressed as ppm/°C (ppm = parts per million). TC is the degree to which the indicated position is affected by ambient temperature changes.

Temperature drift is:

$$\frac{(TC \times \text{full scale output} \times \Delta \text{temperature})}{10^6}$$

or

$$\frac{(25 \text{ ppm} \times 10 \text{ VDC} \times 5 \text{ }^\circ\text{C})}{10^6} = 1.25 \text{ mV}$$

Example

(Sensor with analog output):

- Output: 0 to 10 VDC
- Stroke length: 200 mm
- Temperature change: 5 °C
- TC= 25 ppm/°C

If the indicated output at 200 mm is 10 VDC, the potential change in indicated output per degree in Celsius. Temperature change is 1.25 mV or 0.025 mm for a 5 °C rise.

W

Warm-up period

The time required for the output to stabilize following power-up of the sensor. This error is characterized by a parallel position of the entire calibration curve.

GENERAL DATA R-SERIES PROFILE AND ROD

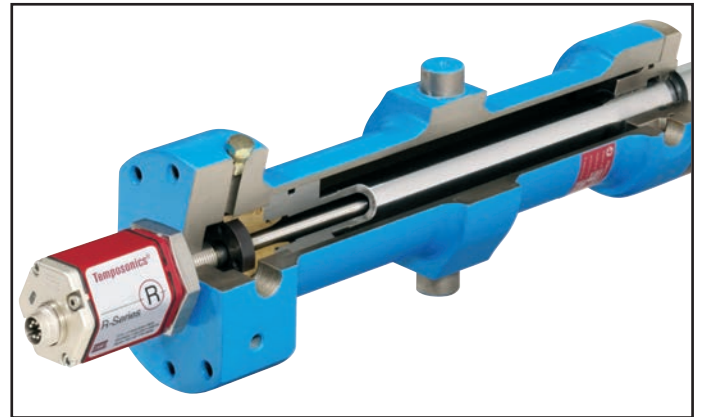
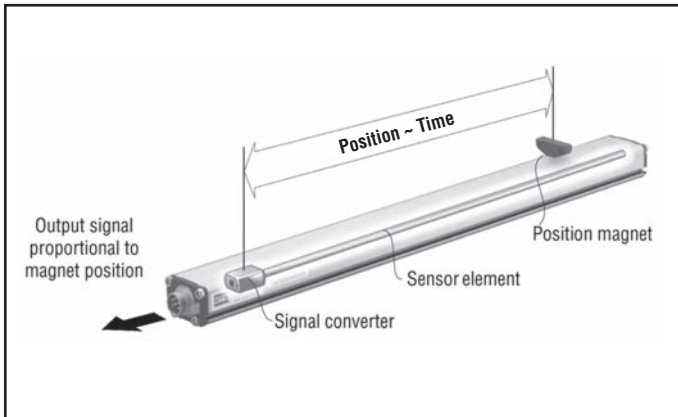

Function

Non-Contact technology - an external movable magnet marks the position - of the absolute Temposonics® linear sensors eliminates the wear, noise and erroneous signal problems and guarantees the best durability without any recalibration.

Design enhances reliability

The extremely robust sensors are modular in mechanics and electronics design.

- A profile or rod-shaped sensor housing protects the sensing element which gives rise to the measurement signal.
- The sensor head accommodates the complete modular electronic interface with active signal conditioning. Double encapsulation ensures high operating safety and optimum EMC protection.
- The position transmitter, a permanent magnet - fixed at the mobile machine part - drives over the sensor's stroke contactlessly and starts measuring through the housing wall.

Temposonics® profile: Rugged sensor in demanding environments

Temposonics® RP perform reliability in even the most rugged industrial environment. The profile model has proved to be the ideal choice where extreme dirt and dust are encountered. Complete encapsulation in a profiled aluminum housing effectively protects the sensor element against damage. The sensor offers flexible mounting configurations and easy installation. Position measurement is wearless by means of magnet heads which require no power supply.

Here you have a choice of two versions:

- A sliding magnet running in profile housing rails. Connection with the mobile machine part is via a ball jointed arm to take up axial forces.
- A floating magnet, mounted directly on the moving machine part, travels over the profile at a low distance. Its air-gap allows the correction of small misalignment at installation.

Temposonics® rod: High pressure design

Just like the sturdy profile model, the rod design is also suitable for even the toughest industrial environments. Temposonics® RH with a pressure-resistant stainless steel flange and sensing rod is suitable for use in hydraulic cylinders and externally in all applications where space is a problem. High-precision position measurement is via ring or U-magnets travelling along the sensing rod without any mechanical contact.

Temposonics®

Absolute, Non-Contact Position Sensors

R-Series Analog

Temposonics® RP and RH
Stroke length 50...7600 mm



100% field adjustable Null and Span

- Rugged industrial sensor
- Linear and absolute measurement
- LEDs for sensor diagnostics
- Non-contact sensing with highest durability
- Superior accuracy: Linearity better 0.01 % F.S.
- Repeatability 0.001 % F.S.
- Direct analog output, position + speed
- Dual magnet position measurement

Sensor diagnostic display

Integrated LEDs (green/red) provide basic visual feedback for normal sensor operation and troubleshooting.

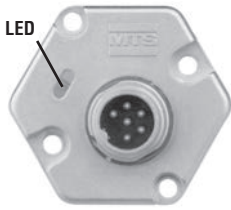

Green	Red	Description
ON	OFF	Normal function
ON	ON	Magnet not detected, Wrong quantity of magnets
ON	Flashing	Magnet out of setup range
Flashing	ON	Programming mode

Output

Smart analog sensors provide direct analog outputs including voltage and current. All outputs allow 100 % adjustments of zero and span setpoints. Since the outputs are direct, no signal conditioning electronics are needed when interfacing with controllers or meters.

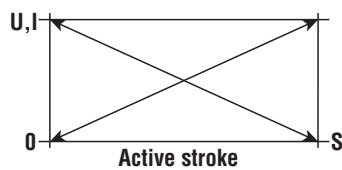

Availability

- Single magnet sensor provides one position output over the entire active stroke length and one velocity output with 1 magnet.
- Dual magnets sensor provides two identical positions outputs; a separate output is provided for each of two magnets positioned along sensor length.

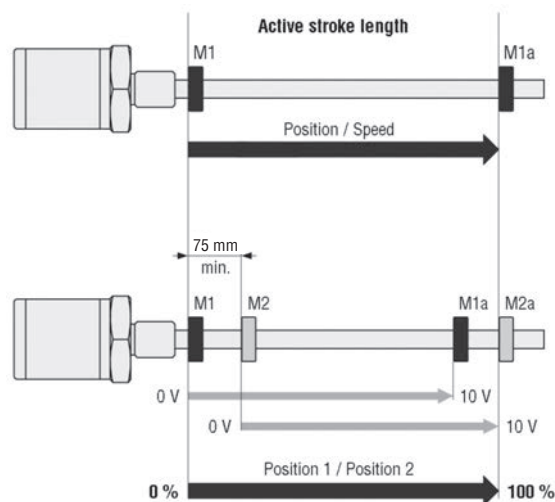

Sensor field programming

Temposonics® R-Series sensors are preconfigured at the factory by model code designation. If needed, MTS offers different external service tools for modifying sensor parameters inside the **active electrical stroke** (minimum 25 mm between setpoints) via the standard connection cable. There is no need to open the sensors electronics. Following tools are available:

1. Hand-Programmer R-Analog for 1 magnet sensor

for easy teach-in setups of stroke length and direction by moving the magnet on desired Null/Span positions and pushing the 0/100 % buttons.



Hand-Programmer R-Analog, part no. 253 124

2. Cabinet-Programmer R-Analog

Cabinet-Programmer R-Analog completes the accessories program of MTS absolute position sensors. The unit can be used for adjusting a connected 1-magnet sensor via the leads, using a simple teach-in procedure in the field.

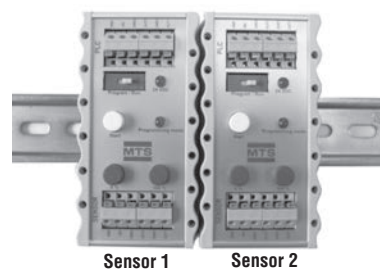

Cabinet-Programmer R-Analog, part no. 253 408

10 x 55 x 31 mm

3. USB-Programmer R-Analog for 1 or 2 magnet's sensors

This hardware converter is required to communicate via USB-port of a Windows PC to the sensor. Customized settings are possible by using the MTS programming software (CD-ROM) for:

- Zero/Span Magnet 1
- Zero/Span Magnet 2
- Velocity range
- Free assignment of outputs to measured position or velocity
- Error output value (e.g. magnet out of stroke)



Programming kit, part no. 253 134-1

(PC-Programmer, power supply, USB-cable, sensor-cable, software)

Windows sensor programming

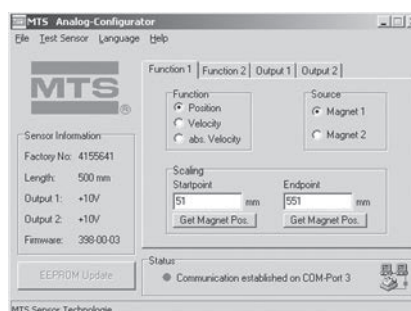

Technical Data

Input

Measured value	Position, velocity / dual magnet position measurements
Stroke length	Profile: 50...5000 mm, Rod: 50...7600 mm

Output

Voltage	0...10 / 10...0 / -10...+10 / +10...-10 VDC (min. load controller: > 5 kOhms)
Current	4(0)...20 mA / 20...4(0) mA (min/max. load: 0/500 Ohms)

Accuracy

Position measurement:	
- Null/Span adjustment	100 % of electrical stroke (min. range 25 mm)
- Resolution	16 bit; 0.0015 % (Minimum 1 µm)
- Linearity	< ± 0.01 % F.S. (Minimum ± 50 µm)
- Repeatability	< ± 0.001 % F.S. (Minimum ± 1 µm)
- Hysteresis	< 4 µm
- Update time	0.5 ms up to 1200 mm / 1.0 ms up to 2400 mm / 2.0 ms up to 4800 mm / 5.0 ms up to 7600 mm stroke length
- Ripple	< 0.01 % F.S.
Velocity measurement:	
- Range	0.025 - 10 m/s
- Deviation	< 0.5 %
- Resolution	0.1 mm/s Option 0.01 mm/s
- Update time (ms)	see position measurement
Temperature coefficient	< 30 ppm/°C

Operating conditions

Magnet speed	any
Operating temperature	-40 °C...+75 °C
Dew point, humidity	90% rel. humidity, no condensation
Ingress protection ¹	Profile: IP65, Rod: IP67, IP68 for cable outlet, RS: IP69K
Shock test	100 g single hit, IEC-Standard 60068-2-27
Vibration test	15 g / 10 - 2000 Hz, IEC-Standard 60068-2-6
Standards, EMC test	Electromagnetic emission EN 61000-6-4 Electromagnetic immunity EN 61000-6-2 EN 61000-4-2/3/4/6, Level 3/4, Criterion A, CE-qualified

Design, material

Diagnostic display	LEDs beside connector
Profile model:	
Sensor head	Aluminum
Sensor stroke	Aluminum
Position magnet	Magnet slider or removable U-magnet
Rod model:	
Sensor head	Aluminum
Rod with flange	Stainless steel 1.4301 / AISI 304
Pressure rating	350 bar, (700 bar peak) for hydraulic rod
Position magnet	Ring magnets, U-magnets

Installation

Mounting position	any orientation
Profile	Movable mounting clamps fixed with M5 x 20 screws or T-slot nuts M5 in base channel
U-magnet, removable	Mounting plate and screws from antimagnetical material
Rod	Threaded flange M18 x 1.5 or 3/4" -16 UNF-3A, Hex nut M18
Position magnet	Mounting plate and screws from antimagnetical material

Electrical connection

Connection type	6 pin connector M16 or cable outlet
Supply voltage	24 VDC (-15 / +20 %); UL Recognition requires an approved power supply with energy limitation (UL 61010-1), or Class 2 rating according to the National Electrical Code (USA) / Canadian Electrical Code.
- Polarity protection	up to -30 VDC
- Overvoltage protection	up to 36 VDC
Current drain	100 mA typical
Ripple	≤ 0.28 Vpp
Electric strength	500 VDC (DC ground to machine ground)

¹ The IP rating is not part of the UL recognition

Stable profile design

Temposonics® RP offers modular construction, flexible mounting configurations and easy installation. Position measurement is contactless via two versions of permanent magnets.

- A sliding magnet running in profile housing rails. Connection with the mobile machine part is via a ball jointed arm to taking up axial forces.
- A floating magnet, mounted directly on the moving machine part, travels over the profile at a low distance. Its air-gap allows the correction of small misalignments at installation.

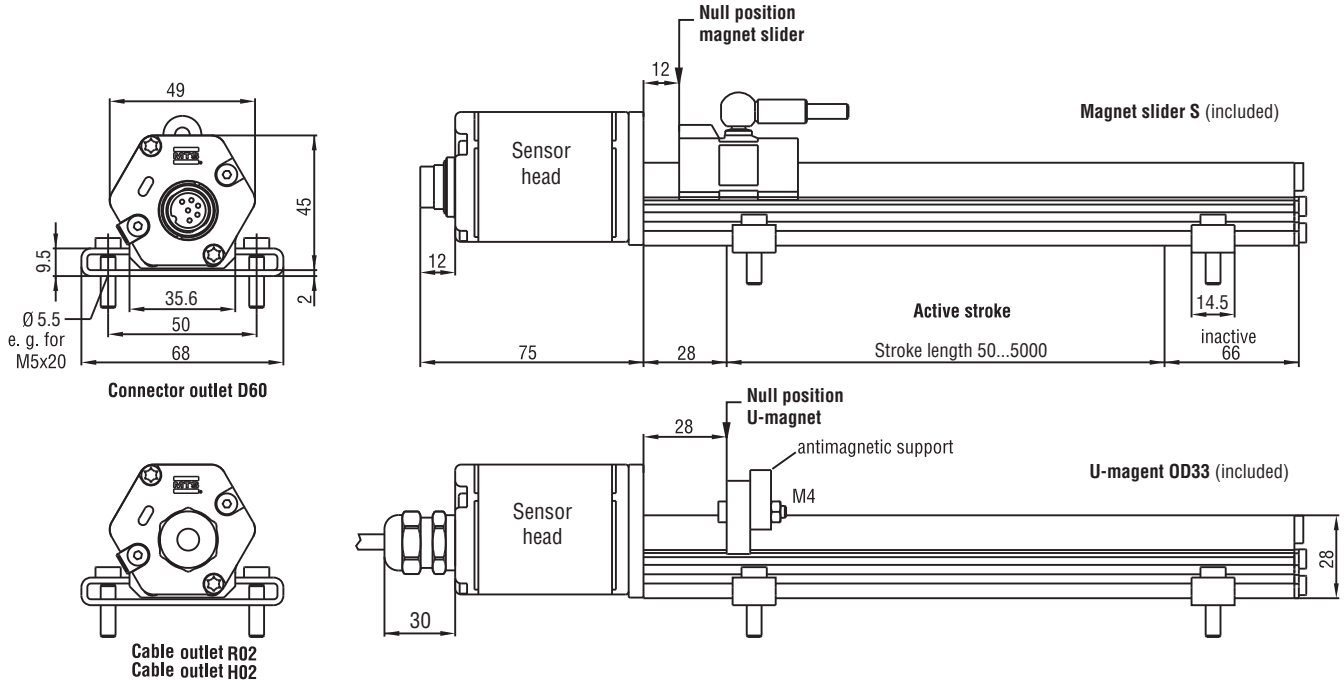

Wiring	Pin	Cable	Function
 <p>Male insert sensor plug rear of cable connector</p>	1	grey	Output 1: Position #1 0...10/10...0/-10...+10/+10...-10 V 4(0)...20/20...4(0) mA
	2	pink	DC Ground
	3	yellow	Output 2: Position #2 or velocity 0...10/10...0/-10...+10/+10...-10 V 4...20/20...4 mA
	4	green	DC Ground
	5	brown	+24 VDC (-15/+20 %)
	6	white	DC Ground (0 V)

All dimensions in mm

Standard position magnet included in delivery (see chapter accessories)

Position magnets

Magnet slider S (part no. 252 182)
Magnet slider V (part no. 252 184)
U-magnet OD33 (part no. 251 416-2)

Connection types

6 pin female connector (part no. 370 623)
6 pin female connector M16, 90° (part no. 370 460)

High pressure rod design

Temposonics® RH with a pressure-resistant stainless steel flange and sensing rod is suitable for use in hydraulic cylinders and externally in all applications where space is a problem. Position measurement is via ring or U-magnets travelling along the sensing rod without any mechanical contact.

Advantage

the completely operable sensor cartridge can be replaced for servicing easily without opening the fluid circuit.

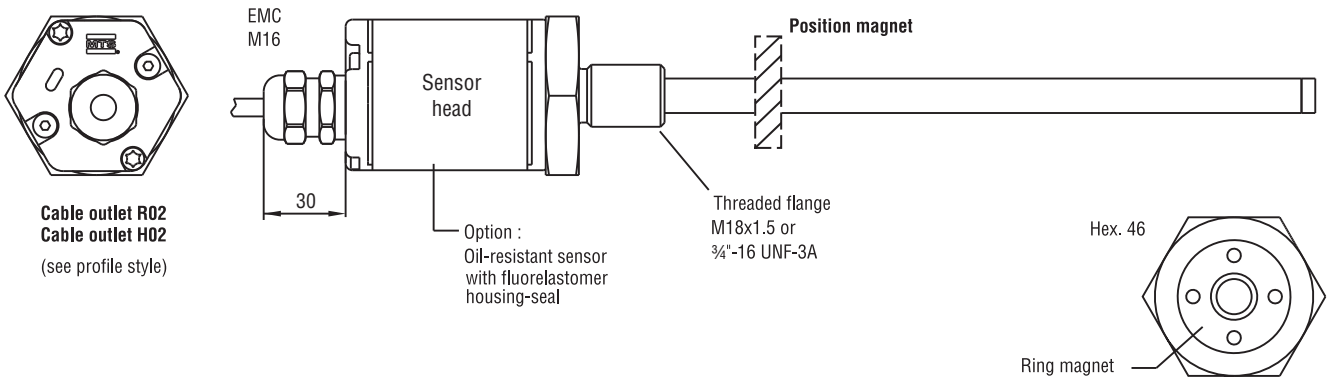
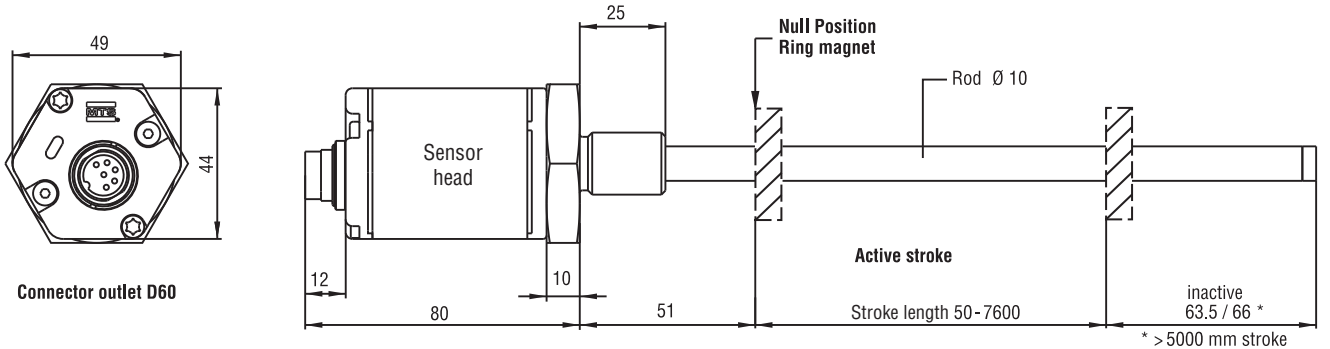

= Magnets must be ordered separately (details see chapter accessories)

Standard position magnets (not included in delivery, please order separately)

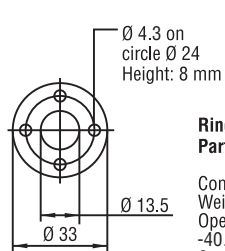

Ring magnet OD33
Part No. 201 542-2
Composite PA-Ferrite-GF20
Weight ca. 14 g
Operating temperature: -40...+100 °C
Surface pressure max. 40 N/mm²
Fastening Torque for M4 screws max. 1 Nm

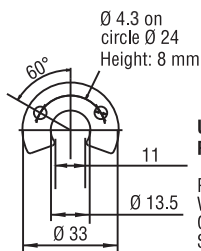

U-magnet OD33
Part No. 251 416-2
PA-Ferrit-GF20
Weight ca. 11 g
Operating temperature: -40...+100 °C
Surface pressure max. 40 N/mm²
Fastening torque for M4 screws max. 1 Nm

All dimensions in mm

Standard position magnet not included in delivery (see chapter accessories)

Position magnets

Ring magnet OD33 (part no. 201 542-2)
Ring magnet OD25,4 (part no. 400 533)
U-magnet OD33 (part no. 251 416-2)

Connection types

6 pin female connector (part no. 370 623)
6 pin female connector M16, 90° (part no. 370 460)

Temposonics®

Sensor model

RP - Profile
RH - Hydraulic rod

Design

Profile Temposonics® RP:

S - Magnet slider, joint at top
V - Magnet slider, joint at front
M - U-magnet, OD33

Rod Temposonics® RH:

M - Flange M18 x 1.5 (Standard)
V - Flange M18 x 1.5 (Fluorelastomer housing-seal)
D - Flange M18 x 1.5 with bushing on rod end
R - Flange M18 x 1.5 with thread M4 at rod end
J - Flange M22 x 1.5, rod Ø 12.7 mm, 800 bar
S - Flange ¾" - 16 UNF - 3A

Stroke length

Profile - 0050...5000 mm

Rod - 0050...7600 mm

Standard: See chart

Other length upon request.

Connection type

D60 - 6 pin male receptacle M16

R02 - 2 m PVC cable w/o connector, Option: R01-R10 (1 - 10 m)

H02 - 2 m PUR cable w/o connector, Option: H01-H10 (1 - 10 m)

Supply voltage

1 - +24 VDC

A - +24 VDC, high vibration resistant (stroke length 25...2000 mm)

Output

1 Output with 1 magnet

Output 1 (position magnet 1)

V01 = 0...10 VDC A01 = 4...20 mA

V11 = 10...0 VDC A11 = 20...4 mA

V21 = -10...+10 VDC A21 = 0...20 mA

V31 = +10...-10 VDC A31 = 20...0 mA

2 Outputs with 2 magnets

Output 1 (position magnet 1) + Output 2 (position magnet 2)

V02 = 0...10 VDC 0...10 VDC

V12 = 10...0 VDC 10...0 VDC

V22 = -10...+10 VDC -10...+10 VDC

V32 = +10...-10 VDC +10...-10 VDC

A02 = 4...20 mA 4...20 mA

2 Outputs with 1 magnet

Output 1 (position magnet 1) + Output 2 (absolute speed magnet 1)

Magnet direction >>>>> Head Null Tip

V01 xxx.x = 0...10 VDC +10.....0.....+10 VDC

V11 xxx.x = 10...0 VDC +10.....0.....+10 VDC

A01 xxx.x = 4...20 mA 20.....4..... 20 mA

A11 xxx.x = 20...4 mA 20.....4..... 20 mA

Output 1 (position magnet 1) + Output 2 (speed magnet 1)

Magnet direction >>>>> Head Null Tip

V61 xxx.x = 0...10 VDC -10.....0.....+10 VDC

V71 xxx.x = 10...0 VDC +10.....0.....-10 VDC

A41 xxx.x = 4...20 mA 4.....12..... 20 mA

Output 1 (position magnet 1) + Output 2 (position magnet 1)

V03 = 0...10 VDC 10...0 VDC

Output 1 (position magnet 1) + Output 2 (electronics temperature)

A04 = 4...20 mA 4...20 mA (-40°C...+100°C)

3 / 7 digits

Included in delivery profile model:

Sensor, Position magnet, 2 mounting clamps up to 1250 mm + 1 clamp for every additional 500 mm

Included in delivery rod model:

Sensor and O-ring.

Magnets must be ordered separately.

Stroke Length Standard RP	
Stroke length	Ordering steps
≤ 500 mm	25 mm
500...2500 mm	50 mm
2500...5000 mm	100 mm

Stroke Length Standard RH	
Stroke length	Ordering steps
< 500 mm	5 mm
500...750 mm	10 mm
750...1000 mm	25 mm
1000...2500 mm	50 mm
2500...5000 mm	100 mm
> 5000 mm	250 mm

Fill in blanks (xxxx) with desired max. speed (see above):

- Speed range 1: 0.1...10 m/s (0001...0100)

Sample: (-5.5...0...5.5 m/s = 10...0...10 VDC) = V01 0055

- Speed range 2: 25...90 mm/s (1025...1090)

Sample: (-50...0...50 mm/s = 4...12...20 mA) = A41 1050

Accessories page 67 and following.

Temposonics®

Absolute, Non-Contact Position Sensors

R-Series CANopen • CANbasic

Temposonics® RP and RH
Stroke length 25...7600 mm

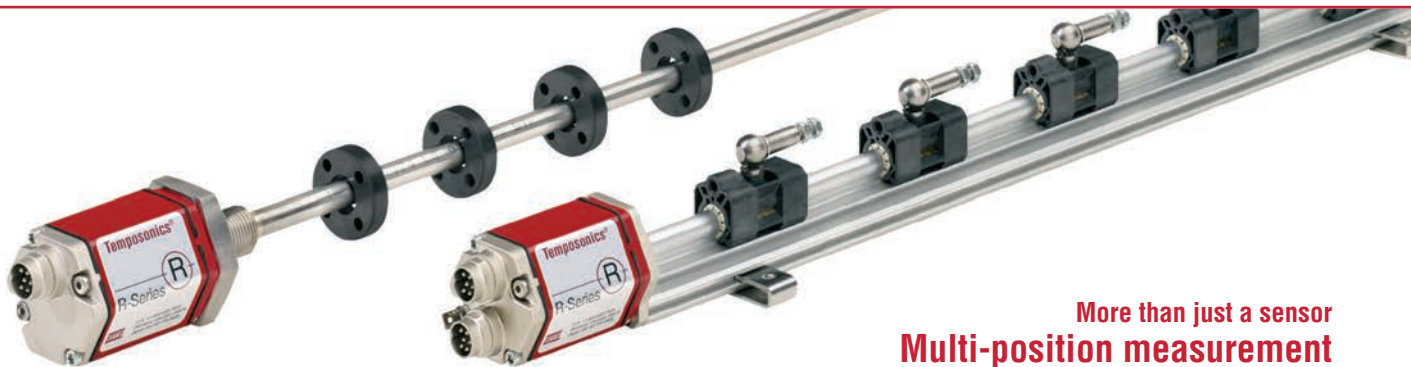

More than just a sensor
Multi-position measurement

- Rugged industrial sensor
- Linear and absolute measurement
- LEDs for sensor diagnostic
- Non-contact sensing with highest durability
- Superior accuracy: Resolution up to 2 μm
- Linearity better 0.01 % F.S.
- Repeatability 0.001 % F.S.
- Sensor-based intelligence
- Direct CAN output, position + velocity
- Multi-position measurement (1 sensor for 20 positions)
- Selectable bus termination (CANopen)
- CANopen with heartbeat-function

Sensor diagnostic display

Integrated LEDs (green/red) provide basic visual feedback for normal sensor operation and troubleshooting.

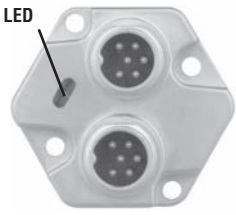

Green	Red	Description
ON	OFF	Normal function
ON	ON	Magnet not detected or wrong quantity of magnets
OFF	ON	Initialization error
Flashing	Flashing	Power out of range (high or low)

CAN Bus Interface

Temposonics® position sensors fulfill - as slave devices - all requirements of the CAN-Bus (ISO 11898). The sensors electronics convert the position measurements into bus oriented outputs and transfer these data directly to the control unit. The bus interface is appropriate for serial data transfer of 1 Mbit/s maximum. Sensor integrated software supports the Bus profiles **CANopen**, **CANbasic** and **DeviceNet** for a comprehensive customized configuration of the sensor-bus system.

Operation modes

CAN sensors provide following measurements with **one** or **multiple** magnets:

1. Standard measurement:

- **CANbasic**: Position + velocity with 1 magnet
- **CANopen**: Position + velocity with 1 - 4 magnets and electronic temperature

2. Multi-Magnet measurement:

- **CANbasic**: Positions for each of 2 - 20 magnets *simultaneously*

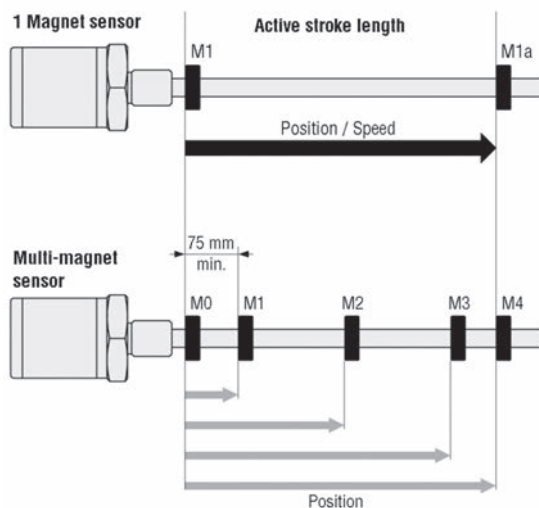

Temposonics® CANbus variations

1. CANopen

is corresponding to encoder profile DS-406 V3.1 (CiA Standard DS-301 V4.02). CANopen functionality describes communication objects (below), which are set via configuration tool.

- **Service Data Object (SDO)** main usage is the sensor configuration. Selectable parameters: Resolution for position + speed, 4 set-points, Preset of operation range and null position for 4 magnets.
- **Process Data Object (PDO)** is used for real-time data transfer of sensor measurements in max. 8 bytes data blocks. The sensor uses PDOs for information about position, speed, limit status, cam-control and operation range of 4 magnets. Data formats: Positions = 32 bit and speed = 16 bit integer value. Limit value = 8 bit.
- **PDO Transmission Type:** Asynchronous (cycle time of 1 to 65'535 ms) or synchronous.
- **Synchronisation Object (SYNC)**
- **Emergency Object**
- **Nodeguard Object**
- **Heartbeat Function**
- **Selectable bus termination**
- **Electronics temperature can be controlled via CANbus**
- **CANopen Configuration Tool** is a software (CD-ROM) and is used as an Electronic Data Sheet (EDS) for sensor configuration. Each sensor will be delivered with an operating manual and an EDS.

2. CANbasic (MTS)

permits a simple, flexible adaption to customized profiles with a short bus access. Here, no configuration tool is needed because parameters are factory set. CANbasic protocol complies with CAN 2.0A standard and always includes the following applications data for 1-magnet measurement: Position, velocity, sensor status and 5 setpoints.

3. CANbasic Multi-Magnet Measurement

provides the position measurement with **maximum 20 magnets on one sensor**. Set-ups and operation are via the on-site control system according to MTS instruction manual.

Data protocols of above CAN options are factory set in the sensor processor, so all versions can be connected directly to the fieldbus.

Conformance test certificate no. CiA199902-301V30/I-004 is given by the CANbus user organisation CiA (CAN in Automation) for MTS CANopen sensors.

Accessory: MTS Servicetool

CANopen address programmer is used for setup the node-address to sensors with CANopen interface. This setup is normally done by the **LMT/LSS-Service** of the bus. Since some master systems do not support this standard, or customer controller system can not handle, this tool - connected to the sensor - can be used for direct setup.

Technical Data

Input

Measured value	Position, velocity / Option: Multi-magnet measurement (max. 20 positions simultaneous)
Stroke length	Profile 25...5000 mm / Rod 25...7600 mm

Output

Interface	CAN-Fieldbus System ISO-DIS 11898						
Data protocol	CANopen: CIA Standard DS 301 V3.0 / Encoder Profile DS 406 V3.1, CANbasic: CAN 2.0 A						
Baud rate, kBit/s	1000	800	500	250	125	50	20
Cable length, m	< 25	< 50	< 100	< 250	< 500	< 1000	< 2500

The sensor will be supplied with ordered baud rate, which is changeable by customer

Accuracy

Resolution	CANopen		CANbasic	
- Position	5 µm	2 µm	5 µm	2 µm
- Speed	0.5 mm/s	0.2 mm/s	1.0 mm/s	0.1 mm/s
Update time	1.0 ms up to 2400 / 2.0 ms up to 4800 / 4.0 ms up to 7600 mm stroke length 0.5 ms up to 1200 mm extra for CANbasic			
Linearity	< ± 0.01 % F.S. (Minimum ± 40 µm) Option internal linearization Linearity tolerance: <u>RP/RH</u> < 300 mm: typ. ± 15 µm, max. ± 25 µm, > 300...600 mm: typ. ± 20 µm, max. ± 30 µm > 600...1200 mm: typ. ± 30 µm, max. ± 50 µm <u>RP</u> 1200...3000 mm: typ. ± 45 µm, max. ± 90 µm, 3...5 m: typ. ± 85 µm, max. ± 150 µm			
Repeatability	< ± 0.001 % F.S. (Minimum ± 2.5 µm)			
Temperature coefficient	< 15 ppm/°C			
Hysteresis	< 4 µm			

Operating conditions

Magnet speed	any
Operating temperature	-40 °C...+75 °C
Dew point, humidity	90% rel. humidity, no condensation
Ingress protection ¹	Profile style: IP65 / Rod style: IP67, IP68 for cable outlet, RS: IP69K
Shock test	100 g, single hit, IEC-Standard 60068-2-27
Vibration test	15 g / 10 - 2000 Hz, IEC-Standard 60068-2-6
Standards, EMC test	Electromagnetic emission EN 61000-6-4 Electromagnetic immunity EN 61000-6-2 EN 61000-4-2/3/4/6, Level 3/4, Criterium A, CE-qualified

Design, material

Diagnostic display	LEDs beside connector
<u>Profile model:</u>	
Sensor head	Aluminum
Sensor stroke	Aluminum
Position magnet	Magnet slider or removable U-magnet
<u>Rod model:</u>	
Sensor head	Aluminum
Rod with flange	Stainless steel 1.4301 / AISI 304
Pressure rating	350 bar, (700 bar peak) for hydraulic rod
Position magnet	Ring magnets, U-magnets

Installation

Mounting position	any orientation
Profile	movable mounting clamps or T-slot nuts M5 in base channel
U-magnet, removable	mounting plate and screws from antimagnetical material
Rod	threaded flange M18 x 1.5 or ¾" -16 UNF-3A, Hex nut M18
Position magnet	mounting plate and screws from antimagnetical material

Electrical connection

Connection type	single or dual 6 pin connectors M16 or cable outlet or 2 x 5 pin connector M12 + 4 pin connector M8
Supply voltage	24 VDC (-15 / +20 %); UL Recognition requires an approved power supply with energy limitation (UL 61010-1), or Class 2 rating according to the National Electrical Code (USA) / Canadian Electrical Code.
- Polarity protection	up to -30 VDC
- Overvoltage protection	up to 36 VDC
Current drain	90 mA typical
Ripple	≤ 0.28 Vpp
Electric strength	500 VDC (DC ground to machine ground)

¹ The IP rating is not part of the UL recognition

Stable profile design

Temposonics® RP offers modular construction, flexible mounting configurations and easy installation. Position measurement is contactless via two versions of permanent magnets.

- A sliding magnet running in profile housing rails. Connection with the mobile machine part is via a ball jointed arm to taking up axial forces.
- A floating magnet, mounted directly on the moving machine part, travels over the profile at a low distance. Its air-gap allows the correction of small misalignments at installation.

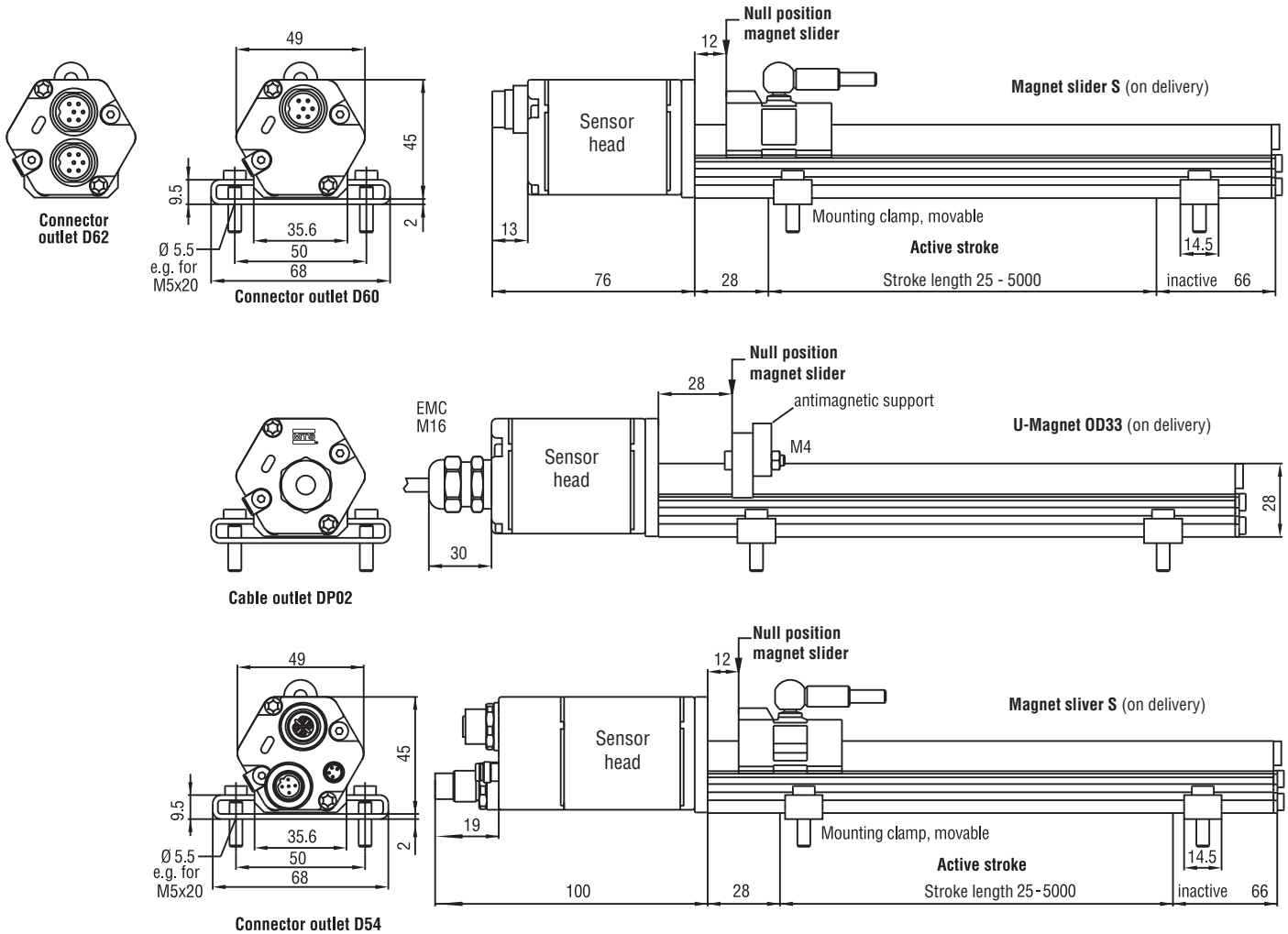

Connector outlet D60/D62

Wiring	Pin	Cable	Function
	1	grey	CAN (-)
	2	pink	CAN (+)
	3	do not connect	---
	4	do not connect	---
	5	brown	+24 VDC (-15 / +20 %)
	6	white	0 V

Male insert sensor plug
rear of cable connector

Connector outlet D54

Wiring	Pin	Function
	1	shield
	2	do not connect
	3	do not connect
	4	CAN (+)
	5	CAN (-)

View:
Front of sensor connector
Back of mating connector

Input voltage	Pin	Cable	Function
	1	brown	+24 VDC (-15 / +20 %)
	2	white	do not connect
	3	blue	0 V (GND)
	4	black	

Male insert sensor plug
rear of cable connector

All dimensions in mm

Standard position magnet included in delivery (see chapter accessories)

Position magnets

Magnet slider S (part no. 252 182)
Magnet slider V (part no. 252 184)
U-magnet OD33 (part no. 251 416-2)

Connection types

6 pin female connector (part no. 370 623)
6 pin female connector M16, 90° (part no. 560 778)

High pressure rod design

Temponics® RH with a pressure resistant stainless steel flange and sensing rod is suitable for use in hydraulic cylinders and externally in all applications where space is a problem. Position measurement is via ring or U-magnets travelling along the sensing rod without any mechanical contact.

Advantage...

the completely operable sensor cartridge can be replaced for servicing easily without opening the fluid circuit.

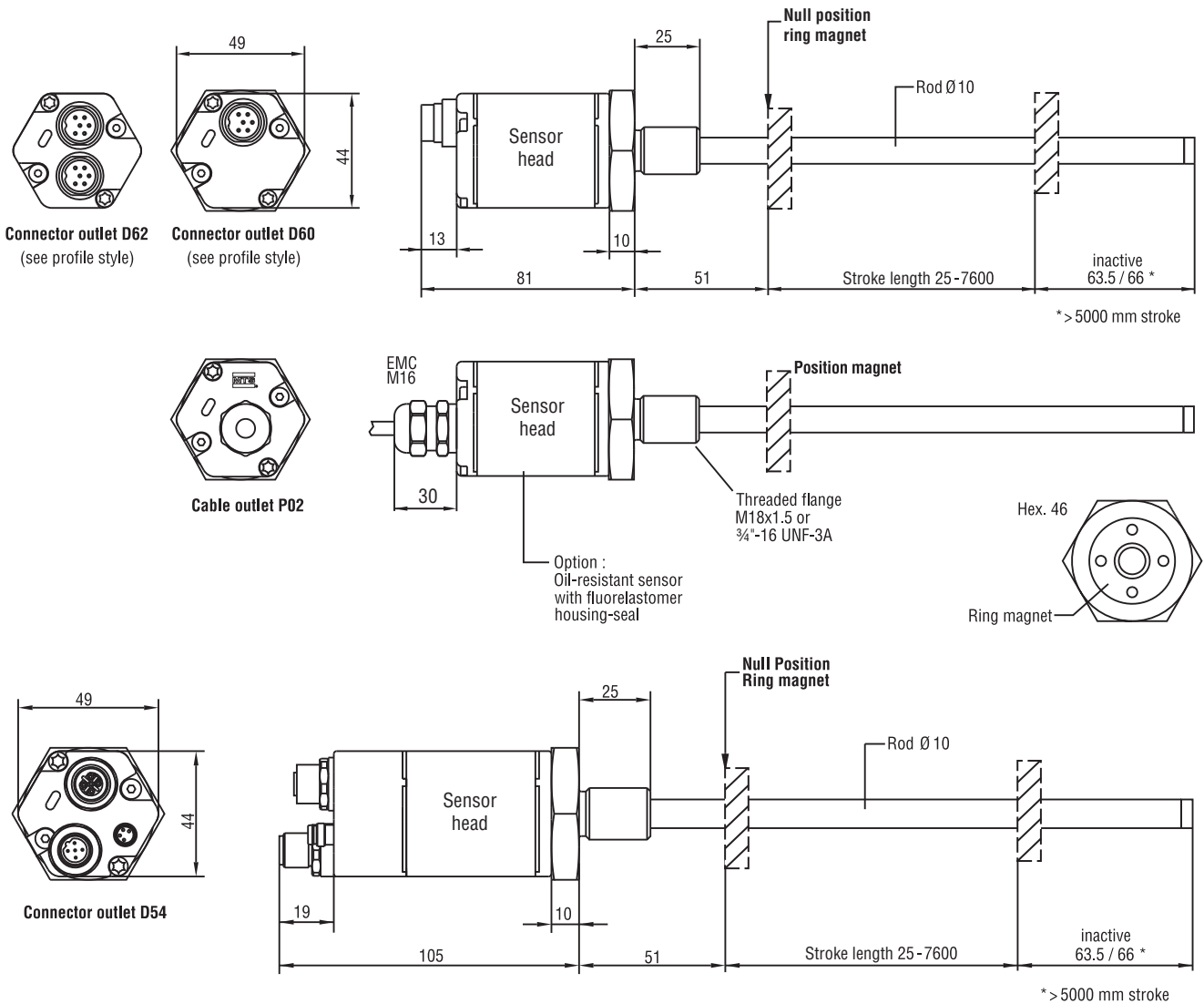

Standard position magnets (not included in, please order separately)

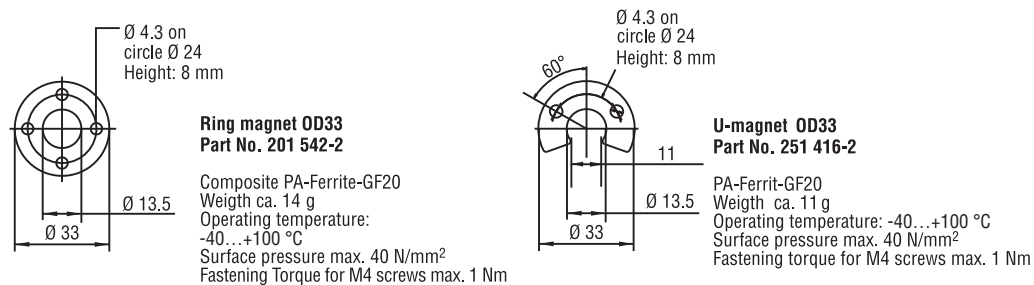

 = Magnets must be ordered separately (details see chapter accessories)

All dimensions in mm

Standard position magnet not included in delivery (see chapter accessories)

Position magnets

Ring magnet OD33 (part no. 201 542-2)
Ring magnet OD25,4 (part no. 400 533)
U-magnet OD33 (part no. 251 416-2)

Connection types

6 pin female connector (part no. 370 623)
6 pin female connector M16, 90° (part no. 560 778)

Temposonics®

Absolute, Non-Contact Position Sensors

R-Series EtherCAT®

Temposonics® RP and RH
Stroke length 25...7600 mm



Advanced communication
...offers multi-position measurement

- Rugged industrial sensor
- Linear and absolute measurement
- LEDs for sensor diagnostics
- Non-contact sensing with highest durability
- Superior accuracy: Linearity better 0.01 % F. S.
- Resolution 1 μm
- Repeatability 0.001 % F.S.
- Direct EtherCAT output
- Position + velocity with 5 magnets
- Positions with up to 20 magnets

Sensor diagnostic display

Integrated LEDs (green/red) provide basic visual feedback for normal sensor operation and troubleshooting.

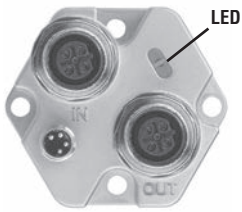

Green	Red	Description
Flashing	OFF	Normal function
Flashing	ON	Magnet not detected or Wrong quantity of magnets
Further diagnostic features programmable.		

Characteristics of the EtherCAT® sensor

Sensor's output

- Position as an absolute value
- Velocity and direction of the drive
- Diagnostics (Status information)
- Error status (e.g. of magnet)

The EtherCAT® Interface

The sensor fulfils the requirements of the EtherCAT field-bus and can be connected as a slave to this bus system. EtherCAT is an open field-bus system which is based on the EtherNet technology (IEEE 802.3) with a high data rate, short response time and a good real-time performance, it is standardized in the IEC/PAS 62407 and it is part of the ISO 15745-4. The integration in the IEC 61158, IEC 61784 and IEC 61800-7 is in the way.

It is very easy to implement the Temposonics® sensor with the EtherCAT interface into an EtherCAT field-bus system. The System-Manager (e.g. TwinCAT from Beckhoff) gets all the parameters of the sensor from the XML-file, which part of the delivery. There are no settings on the sensor.

The measurement can be synchronized by the PLC, by switching the sensor to the “distributed clock mode” (1 - 5 magnets only).

Operation mode

There are two versions available:

E101 1 - 5 magnet measurement

Measuring in parallel the position and velocities of up to 5 magnets.

The data telegram contains from each magnet:

- Position (32 bit)
- Velocity (32 bit)
- Long status information (16 bit)

E102 1 - 20 multi-magnet measurement

Measuring in parallel the positions of up to 20 magnets.

The data telegram contains from each magnet:

- Position (32 bit)
- Velocity (32 bit)
- Long status information (16 bit)

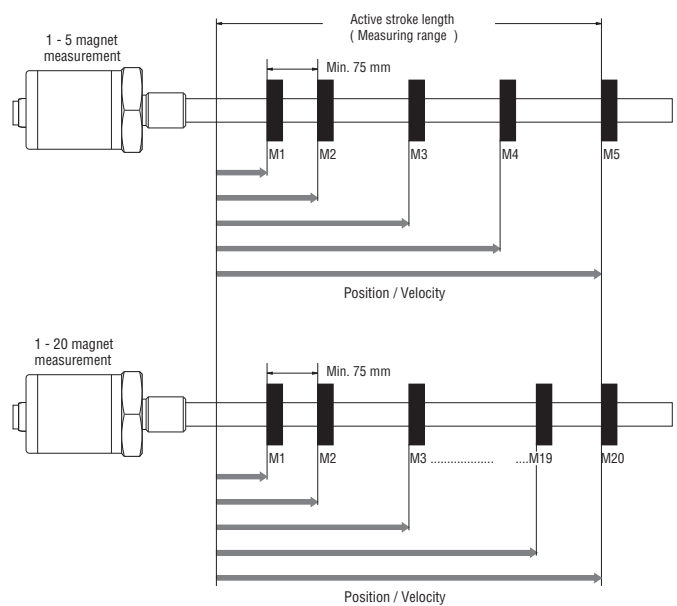

Technical Data
Input

Measured value	Position / Velocity 1 - 5 magnet measurement option 1 - 20 magnet measurement
Stroke length	Profile 25...5000 mm / Rod 25...7600 mm

Output

Output signal	EtherCAT Ethernet Control Automation Technology
Data format	EtherCAT 100 Base-Tx, Fast Ethernet
Data transmission rate	100 MBit/s max.

Accuracy

Resolution	
- Position	1...1000 µm selectable
- Speed	1 µm/s (Quality rating) adjustable according to velocity and stroke length
Linearity	< ± 0.01 % F.S. (Minimum ± 50 µm) Option internal linearization Linearity tolerance: <u>RP/RH</u> < 300 mm: typ. ± 15 µm, max. ± 25 µm, > 300...600 mm: typ. ± 20 µm, max. ± 30 µm > 600...1200 mm: typ. ± 30 µm, max. ± 50 µm <u>RP</u> 1200...3000 mm: typ. ± 45 µm, max. ± 90 µm, 3...5 m: typ. ± 85 µm, max. ± 150 µm
Repeatability	< ± 0.001 % F.S. (Minimum ± 2.5 µm)
Cycle time	Stroke length dependent
Data transmission rate	≤ 10 kHz (oversampling is active while the scanning cycle is shorter than the measuring cycle.)
Temperature coefficient	< 15 ppm/°C
Ripple	< 5 µm
Hysteresis	< 4 µm

Operating conditions

Magnet speed	any
Operating temperature	-40 °C...+75 °C
Dew point, humidity	90 % rel. humidity, no condensation
Ingress protection ¹	Profile: IP65, Rod: IP67, if mating connector is correctly fitted, RS: IP69K
Shock test	100 g single hit, IEC-Standard 60068-2-27
Vibration test	15 g / 10 - 2000 Hz, IEC-Standard 60068-2-6
Standards, EMC test	Electromagnetic emission EN 61000-6-4 Electromagnetic immunity EN 61000-6-2 EN 61000-4-2/3/4/6, Level 3/4, Criterion A, CE-qualified

Design, Material

Diagnostic display	LEDs beside connector
<u>Profile model:</u>	
Sensor head	Aluminum
Sensor stroke	Aluminum
Position magnet	Magnet slider or removable U-magnet
<u>Rod model:</u>	
Sensor head	Aluminum
Rod with flange	Stainless steel 1.4301 / AISI 304
Pressure rating	350 bar, (700 bar peak) for hydraulic rod
Position magnet	Ring magnets, U-magnets

Installation

Mounting position	any orientation
Profile	Movable mounting clamps or T-slot nuts M5 in base channel
U-magnet, removable	Mounting plate and screws from antimagnetical material
Rod	Threaded flange M18 x 1.5 or ¾" -16 UNF-3A, Hex nut M18
Position magnet	Mounting plate and screws from antimagnetical material

Electrical connection

Connection type	2 x 4 pin connector M12-D
Supply voltage	24 VDC (-15 / +20 %); UL Recognition requires an approved power supply with energy limitation (UL 61010-1), or Class 2 rating according to the National Electrical Code (USA) / Canadian Electrical Code.
- Polarity protection	up to -30 VDC
- Overvoltage protection	up to 36 VDC
Current drain	80 mA typical
Ripple	≤ 0.28 Vpp
Electric strength	500 VDC (DC ground to machine ground)

¹ The IP rating is not part of the UL recognition

Stable profile design

Tempsonics® RP offers modular construction, flexible mounting configurations and easy installation. Position measurement is contactless via two versions of permanent magnets.

- A sliding magnet running in profile housing rails. Connection with the mobile machine part is via a ball jointed arm to taking up axial forces.
- A floating magnet, mounted directly on the moving machine part, travels over the profile at a low distance. Its air-gap allows the correction of small misalignments at installation.

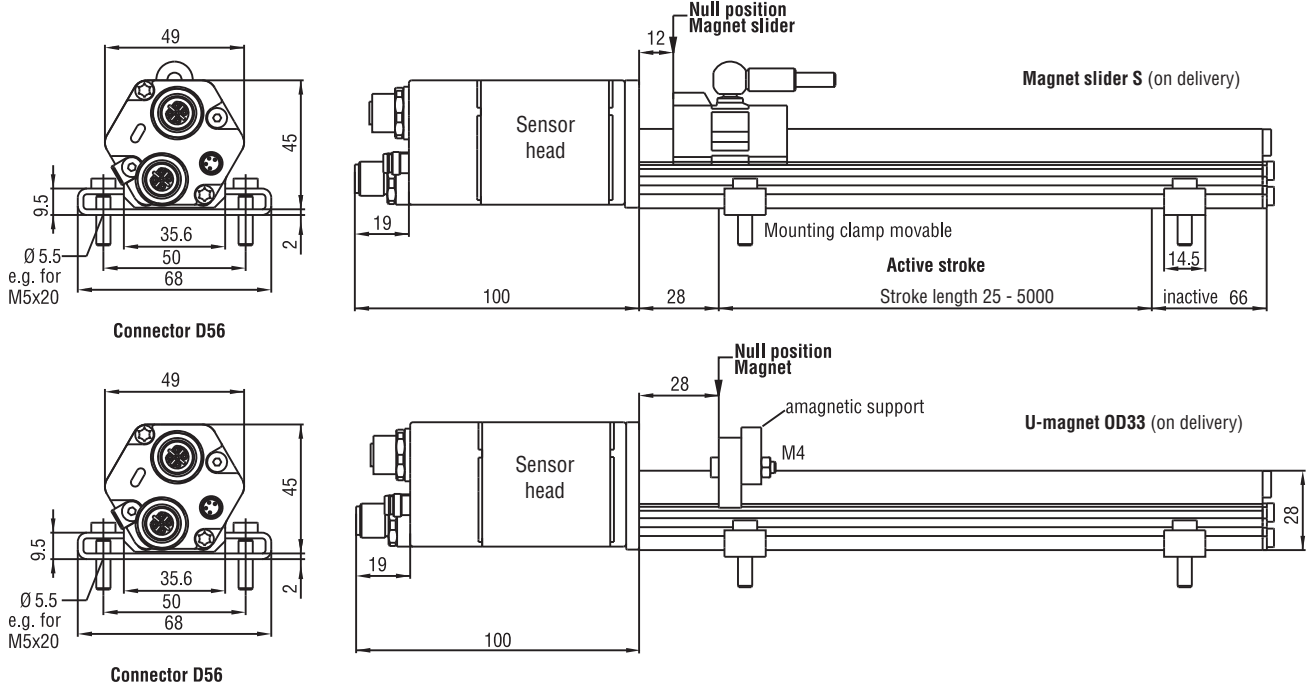

Connection	BUS In / Out	Pin	Cable	Function
View Connector side Sensor		1	yellow	Tx+
		2	white	Rx+
		3	orange	Tx-
		4	blue	Rx-

Input voltage	Pin	Cable	Function
	1	brown	+24 VDC (-15 / +20 %)
	2	white	do not connect
	3	blue	0 V (GND)
	4	black	do not connect

All dimensions in mm

Standard position magnet included in delivery (see chapter accessories)

Position magnets

Magnet slider S (part no. 252 182)
 Magnet slider V (part no. 252 184)
 U-magnet OD33 (part no. 251 416-2)

Connection types

Cable connector (part no. 530 066)
 Cable connector (part no. 530 064)
 4 pin Bus cable connector (part no. 370 523)

High pressure rod design

Temposonics® RH with a pressureresistant stainless steel flange and sensing rod is suitable for use in hydraulic cylinders and externally in all applications where space is a problem. Position measurement is via ring or U-magnets travelling along the sensing rod without any mechanical contact.

Advantage...

the completely operable sensor cartridge can be replaced for servicing easily without opening the fluid circuit.

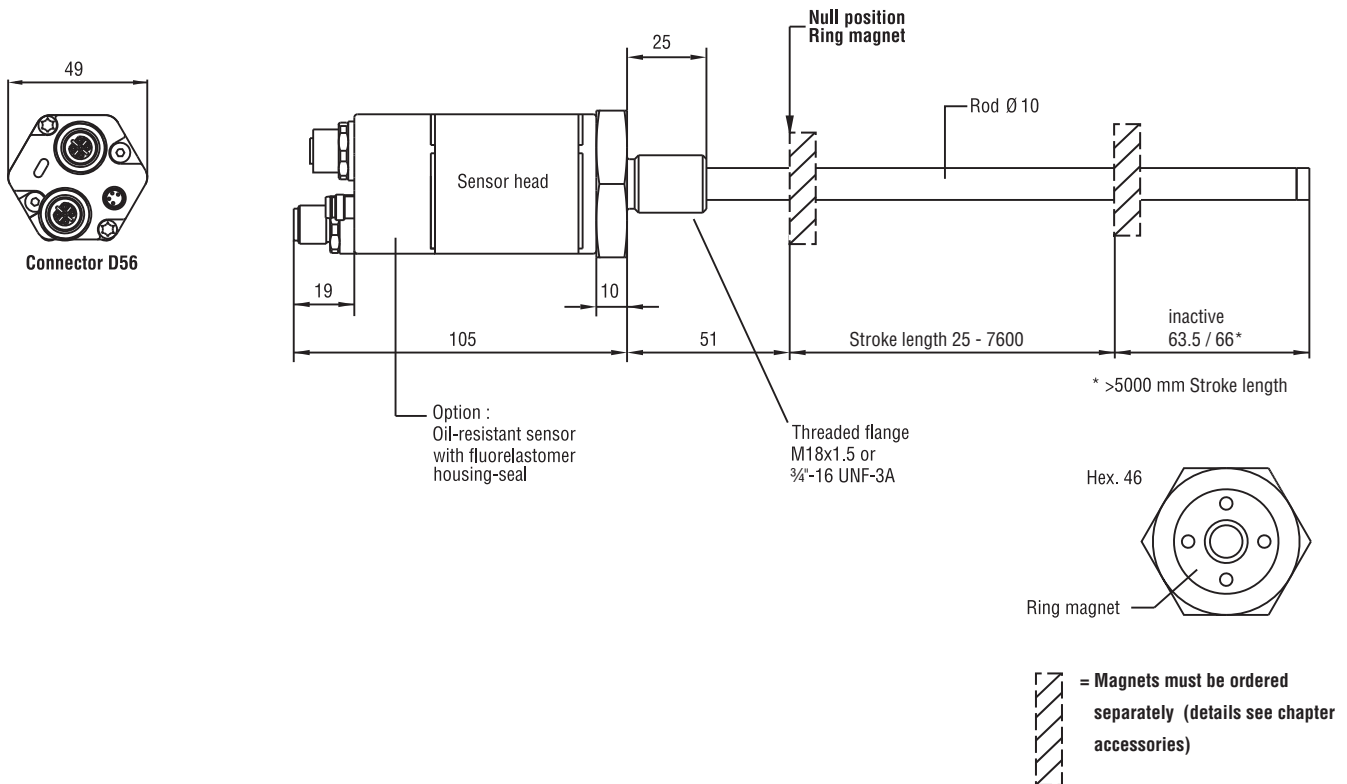

Standard position magnets (not included in delivery, please order separatley)

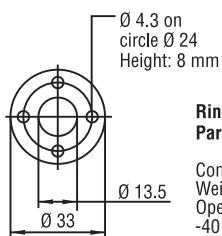

Ring magnet OD33
Part No. 201 542-2

Composite PA-Ferrite-GF20
Weigth ca. 14 g
Operating temperature:
-40...+100 °C
Surface pressure max. 40 N/mm²
Fastening Torque for M4 screws max. 1 Nm

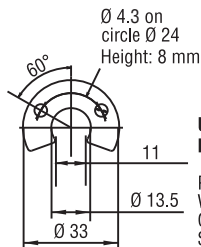

U-magnet OD33
Part No. 251 416-2

PA-Ferrit-GF20
Weigth ca. 11 g
Operating temperature: -40...+100 °C
Surface pressure max. 40 N/mm²
Fastening torque for M4 screws max. 1 Nm

All dimensions in mm

Standard position magnet not included in delivery (see chapter accessories)

Position magnets

Ring magnet OD33 (part no. 201 542-2)
Ring magnet OD25,4 (part no. 400 533)
U-magnet OD33 (part no. 251 416-2)

Connection types

Cable connector (part no. 530 066)
Cable connector (part no. 530 064)
4 pin Bus cable connector (part no. 370 523)

Temposonics®

Absolute, Non-Contact Position Sensors

R-Series Profibus

Temposonics® RP and RH
Stroke length 25...7600 mm



**Advanced Communication
...offers Multi-Position Measurement**

- Rugged industrial sensor
- Linear and absolute measurement
- LEDs for sensor diagnostics
- Non-contact sensing with highest durability
- Superior accuracy: Linearity better 0.01 %
- Resolution up to 1 μm
- Repeatability 0.001 %
- Direct Profibus-DP output, position
- Multi-position measurement: 1 sensor for max. 20 positions

Sensor diagnostic display

Integrated LEDs (green/red) provide basic visual feedback for normal sensor operation and troubleshooting.

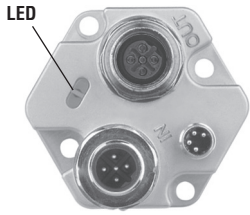

Green	Red	Description
ON	OFF	Normal function
ON	ON	Magnet not detected or wrong quantity of magnets
Flashing	OFF	Waiting for Master parameters
Flashing	ON	Programming mode

Profibus interface

Temposonics® sensors fulfill all requirements of PROFIBUS-DP (EN 50170). The sensor realizes the absolute position measuring with direct transmission of serial, bitsynchronous data in RS485 standard to control units in a baud rate of 12 Mbit/s maximum. PROFIBUS interface is built-up with Siemens buscontroller SPC3. In addition to applications data transmission, PROFIBUS provides powerful functions for diagnostics and configuration, loaded into the bus via the GSD (Electronic Device Data Sheet).

Profibus sensors - corresponding DP-slave Class 2 - featuring

Sensor outputs:

- Absolute position measurement
- Sensor status
- Error detection (e.g. magnet status)

Selectable parameters:

- Offset/Preset for each magnet
- Measuring direction: Forward/reverse
- Resolution
- Different data formats

Operation mode:

P101 1-20 multi-magnet measurement

Position measurement of max. 20 magnets simultaneously

P102 1 magnet measurement (Standard)

Positions measurement 1 magnet

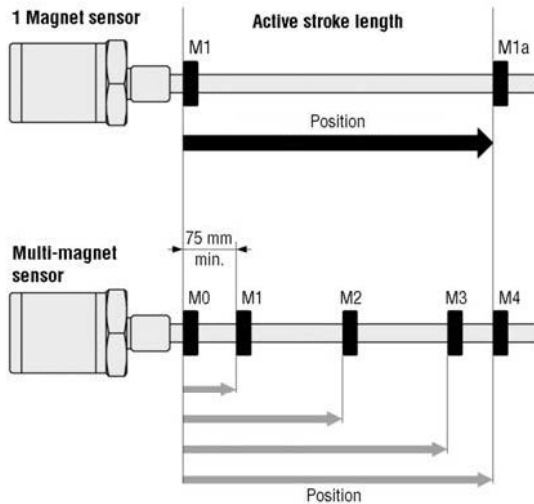

Data exchange

With multi-magnet measurement, 1 status byte and 3 bytes of position data for each position are transmitted. The status byte contains e.g. the error bit and the position number of the following measurement value. Dependent on sensor parameters setting, the position data can be transferred to the control unit in different formats (e.g. Intel or Motorola format).

Accessory: MTS servicetool

Profibus address-programmer is used for setup sensor's slave address.

Normally addressing is done by Profibus **SetSlaveAddress**. Since some master systems do not support this standard, or customers controller can not handle, this tool - connected to the sensor - can be used for direct addressing.

Technical Data

Input

Measured value	Position / Option: Multi-magnet measurement (max. 20 positions)
Stroke length	Profile 25...5000 mm / Rod 25...7600 mm

Output

Output signal	IEC 61158 CPF3 PROFIBUS
Data format	PROFIBUS-DP slave
Data transmission rate	Max. 12 Mbit/s

Accuracy

Resolution	
- Position	1 µm / other values selectable via GSD-file < ± 0.01 % F.S. (Minimum ± 50 µm)
Linearity	Option internal linearization Linearity tolerance: <u>RP/RH</u> < 300 mm: typ. ± 15 µm, max. ± 25 µm, > 300 ... 600 mm: typ. ± 20 µm, max. ± 30 µm > 600...1200 mm: typ. ± 30 µm, max. ± 50 µm <u>RP</u> 1200...3000 mm: typ. ± 45 µm, max. ± 90 µm, 3...5 m: typ. ± 85 µm, max. ± 150 µm
Option internal linearization	Linearity ± 20 µm...± 70 µm = 100 mm...5000 mm ML
Repeatability	< ± 0.001 % F.S. (Minimum ± 2.5 µm)
Cycle time, standard (1 magnet)	0,5 ms at 500 mm / 1 ms at 2000 mm / 2 ms at 4500 mm / 3.1 ms at 7600 mm stroke length each additional magnet + 0.05 ms
Temperature coefficient	< 15 ppm/°C
Ripple	< 5 µm
Hysteresis	< 4 µm

Operating conditions

Magnet speed	any
Operating temperature	-40 °C...+75 °C
Dew point, humidity	90% rel. humidity, no condensation
Ingress protection ¹	Profile: IP65, Rod: IP67, if mating connector is correctly fitted, RS: IP69K
Shock test	100 g single hit, IEC-Standard 60068-2-27
Vibration test	15 g / 10 - 2000 Hz, IEC-Standard 60068-2-6
Standards, EMC test	Electromagnetic emission EN 61000-6-4 Electromagnetic immunity EN 61000-6-2 EN 61000-4-2/3/4/6, Level 3/4, Criterium A, CE-qualified

Design, material

Diagnostic display	LEDs beside connector
<u>Profile model:</u>	
Sensor head	Aluminum
Sensor stroke	Aluminum
Position magnet	Magnet slider or removable U-magnet
<u>Rod model:</u>	
Sensor head	Aluminum
Rod with flange	Stainless steel 1.4301 / AISI 304
Pressure rating	350 bar, (700 bar peak) for hydraulic rod
Position magnet	Ring magnets, U-magnets

Installation

Mounting position	any orientation
Profile	Movable mounting clamps or T-slot nuts M5 in base channel
U-magnet, removable	Mounting plate and screws from antimagnetical material
Rod	Threaded flange M18 x 1.5 or ¾" -16 UNF-3A, Hex nut M18
Position magnet	Mounting plate and screws from antimagnetical material

Electrical connection

Connection type	2 x 6 pin connector M16 or 2 x 5 pin connector M12 + 4 pin, connector M8 Cable outlet 2 x 0 - 10 m PUR-cable + 4 pin, connector M8
Supply voltage	24 VDC (-15 / +20 %); UL Recognition requires an approved power supply with energy limitation (UL 61010-1), or Class 2 rating according to the National Electrical Code (USA) / Canadian Electrical Code.
- Polarity protection	up to -30 VDC
- Overvoltage protection	up to 36 VDC
Current drain	90 mA typical
Ripple	≤ 0.28 Vpp
Electric strength	500 VDC (DC ground to machine ground)

¹ The IP rating is not part of the UL recognition

Stable profile design

Temposonic® RP offers modular construction, flexible mounting configurations and easy installation. Position measurement is contactless via two versions of permanent magnets.

- A sliding magnet running in profile housing rails. Connection with the mobile machine part is via a ball jointed arm to taking up axial forces.
- A floating magnet, mounted directly on the moving machine part, travels over the profile at a low distance. Its air-gap allows the correction of small misalignments at installation.

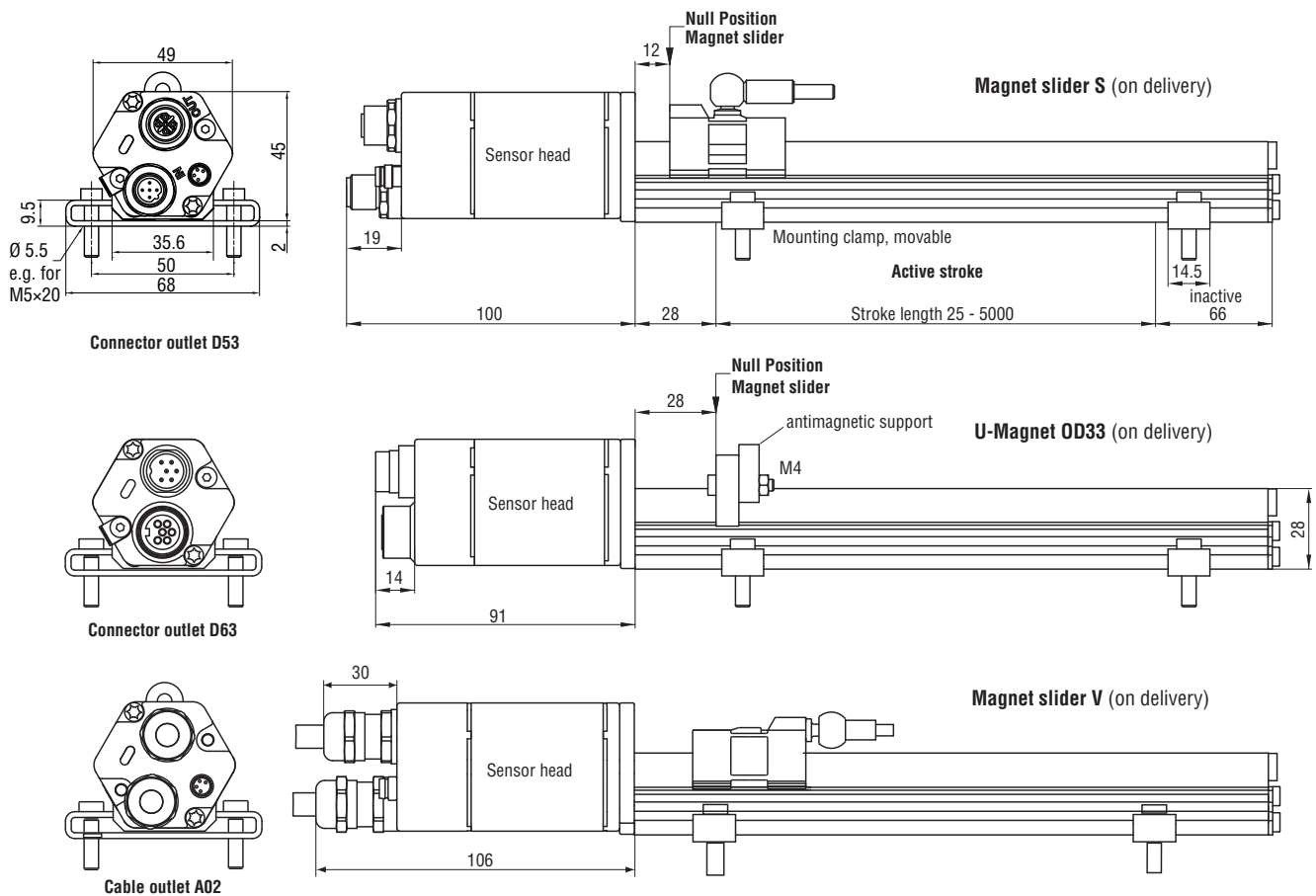

Wiring D63		Pin	Cable	Function
<p>male female</p> <p>Male insert sensor plug rear of cable connector</p>	1	green	RxD/TxD-N (Bus)	
	2	red	RxD/TxD-P (Bus)	
	3	---	DGND (for Bus termination)*	
	4	---	VP (for Bus termination)*	
	5	black	+24 VDC (-15 / +20 %)	
	6	blue	DC Ground (0V)	
	-	yellow/green	do not connect	
				*female only

Wiring D53 Bus connector		Pin	Cable	Function
<p>male female</p> <p>Inserts sensor plug rear of cable connector</p>	1	---	VP+5 (for Bus termination)*	
	2	green	RxD/TxD-N (Bus)	
	3	---	DGND (for Bus termination)*	
	4	red	RxD/TxD-P (Bus)	
	5	shield	shield	
				*female only

Input voltage	Pin	Cable	Function
<p>Male insert sensor plug rear of cable connector</p>	1	brown	+24 VDC (-15 / +20 %)
	2	white	do not connect
	3	blue	0 V (GND)
	4	black	do not connect

All dimensions in mm

Standard position magnet included in delivery (see chapter accessories)

Position magnets

- Magnet slider S (part no. 252 182)
- Magnet slider V (part no. 252 184)
- U-magnet OD33 (part no. 251 416-2)

Connection types

- 5 pin female connector M12-B (part no. 560 885)
- 5 pin male connector M12-B (part no. 560 884)
- 4 pin cable connector M8, 90° (part no. 560 886)

High pressure rod design

Temposonics® RH with a pressure-resistant stainless steel flange and sensing rod is suitable for use in hydraulic cylinders and externally in all applications where space is a problem. Position measurement is via ring or U-magnets travelling along the sensing rod without any mechanical contact.

Advantage...

the completely operable sensor cartridge can be replaced for servicing easily without opening the fluid circuit.

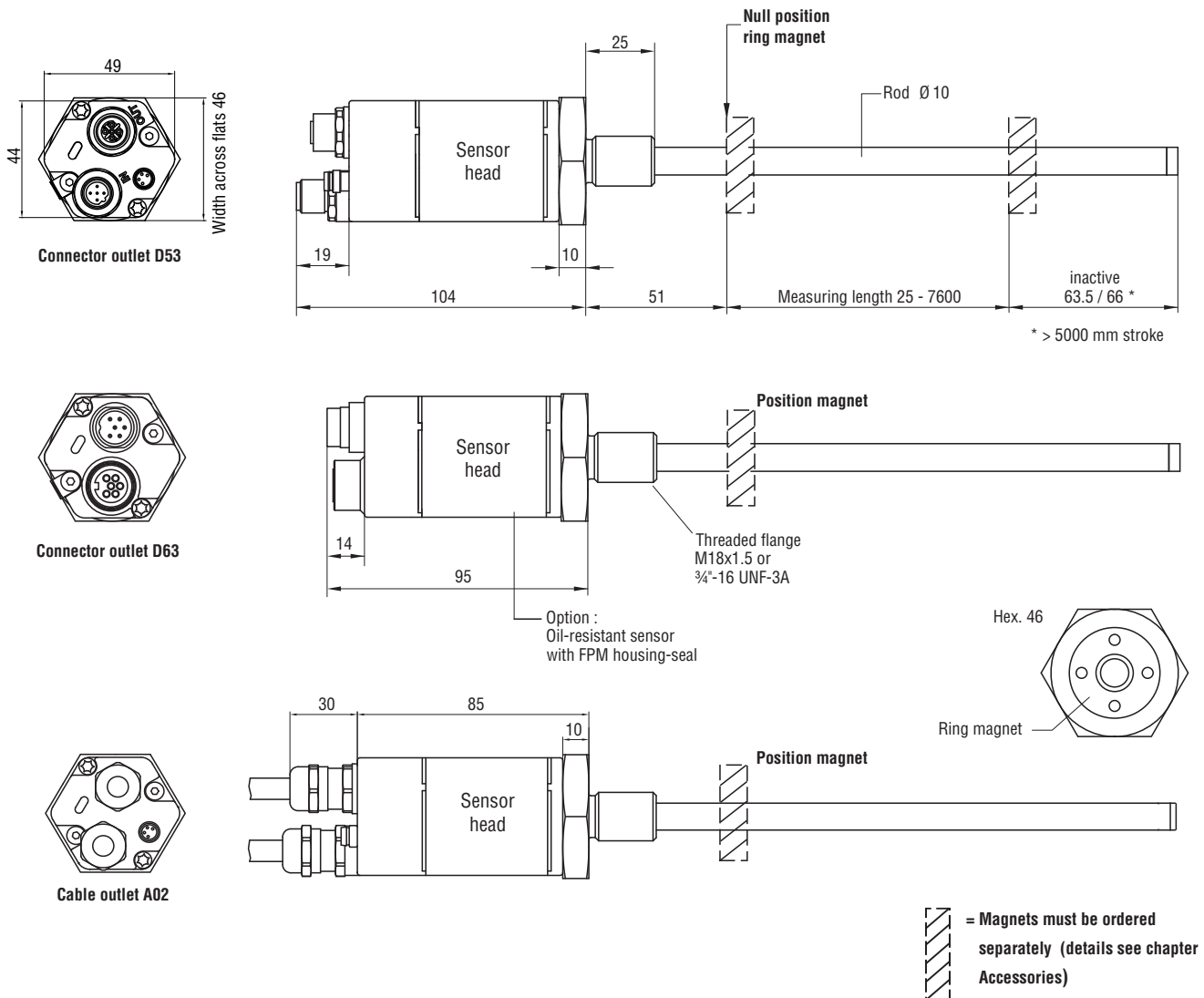

Standard position magnets (not included in delivery, please order separately)

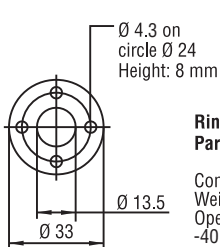

Ring magnet OD33
Part No. 201 542-2

Composite PA-Ferrite-GF20
Weight ca. 14 g
Operating temperature: -40...+100 °C
Surface pressure max. 40 N/mm²
Fastening Torque for M4 screws max. 1 Nm

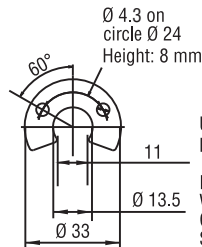

U-magnet OD33
Part No. 251 416-2

PA-Ferrit-GF20
Weight ca. 11 g
Operating temperature: -40...+100 °C
Surface pressure max. 40 N/mm²
Fastening torque for M4 screws max. 1 Nm

All dimensions in mm

Standard position magnet not included in delivery (see chapter accessories)

Position magnets

Ring magnet OD33 (part no. 201 542-2)
Ring magnet OD25,4 (part no. 400 533)
U-magnet OD33 (part no. 251 416-2)

Connection types

5 pin female connector M12-B (part no. 560 885)
5 pin male connector M12-B (part no. 560 884)
4 pin cable connector M8, 90° (part no. 560 886)

Temposonics® **M** **P** **Z**

Sensor model

RP - Profile
RH - Rod

Design

Profile Temposonics® RP:

S - Magnet slider, joint at top
V - Magnet slider, joint at front
G - Magnet slider, joint at top, backlash free
M - U-magnet, OD33

Rod Temposonics® RH:

M - Flange M18 x 1.5 (Standard)
V - Flange M18 x 1.5 (Fluorelastomer housing-seal)
D - Flange M18 x 1.5 with bushing on rod end
R - Flange M18 x 1.5 with thread M4 at rod end
J - Flange M22 x 1.5, rod Ø 12.7 mm, 800 bar
S - Flange ¾" - 16 UNF - 3A

Stroke length

Profile - 0025...5000 mm
Rod - 0025...7600 mm
Standard: See chart
Other length upon request.

Connection type

D63 - 2 x 6 pin male/female receptacle M16
D53 - 2 x 5 pin male/female receptacle M12, 4 pin male receptacle M8
A02 - 2 m PUR-cable w/o connector, option: A01-A10 (1 - 10 m)

Supply voltage

1 - +24 VDC
A - +24 VDC, high vibration resistant (stroke length 25...2000 mm)

Output

P = Profibus-DP
101 - Profibus-DP, Multi-position measurement, 1 - 20 positions (Standard)
102 - Profibus-DP, Single-position measurement (Standard)
105 - Profibus-DP, Single- and multi-position measurement, 1 - 15 positions, internal linearization (Specified tolerances valid for single-position measurement)

Magnet number for multi-position measurement*

Z02 - Z20 = 2 - 20 pcs

* Note: Please specify magnet numbers for your sensing application and order separately

Note
Projecting and parameterizing a Profibus system will be done with servicetool of Profibus mastersystem supplier.

Included in delivery profile model:

Sensor, magnet slider or U-magnet, 2 mounting clamps up to 1250 mm stroke + 1 clamp for every additional 500 mm.

Included in delivery rod model:

Sensor and O-ring.
Magnets must be ordered separately. Use signed magnets for sensors w/LCO

Stroke Length Standard RP	
Stroke Length	Ordering Steps
≤ 500 mm	25 mm
500...2500 mm	50 mm
2500...5000 mm	100 mm

Stroke Length Standard RH	
Stroke Length	Ordering Steps
< 500 mm	5 mm
500...750 mm	10 mm
750...1000 mm	25 mm
1000...2500 mm	50 mm
2500...5000 mm	100 mm
> 5000 mm	250 mm

Temposonics®

Absolute, Non-Contact Position Sensors

R-Series Profinet

Temposonics® RP and RH
Stroke length 25...7600 mm



- Rugged industrial sensor
- Linear and absolute measurement
- LEDs for sensor diagnostics
- Non-contact sensing with highest durability
- Superior accuracy: linearity less than 0.01 %
- Repeatability less than 0.001 %
- Resolution up to 1 μm
- Direct Profinet output with:
 - Multi-position measurement with up to 19 magnets
 - Speed
 - Integrated IRT switch

Sensor diagnostic display

Integrated LED (green/red) provides basic visual feedback for normal sensor operation and troubleshooting.

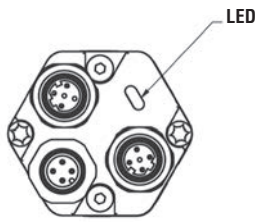

Green	Red	Description
ON	OFF	Normal function
ON	ON	No master contact
ON	Flashing	Parametrization failed

See manual for more diagnostic functions

The most important characteristics of Profinet are:

- absolute position measurement
- speed measurement
- status announcement
- error message (e.g. of magnet)

Profinet interface

The sensor meets the requirements of the Profinet IO industrial Ethernet standards and can be directly operating in a network with decentralized peripherals. Profinet is characterized by a high data transfer and high real-time capability. It's officially certified by the PNO (Profinet user organization).

Profinet versions

The sensor can be ordered in following versions:

- Encoder Profile 4.1: PNO standardized profile
- MTS Communication Profile: It allows a simultaneous position measurement up to 19 positions. The configuration is similar to the sequence of Temposonics® Profibus sensors

1...19 multi-position measurement

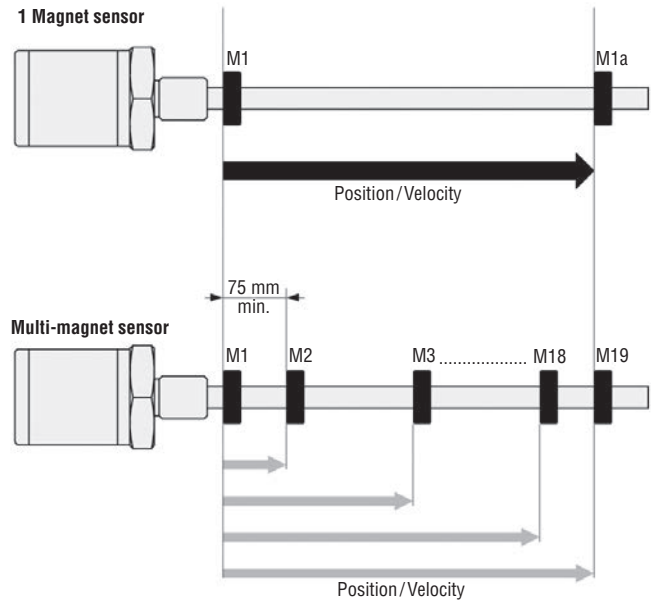

Technical data

Input

Measured value	position or velocity, option: 1...19 multi-position measurement
Measuring length	profile: 25...5000 mm / rod: 25...7600 mm

Output

Interface/Data protocol	Profinet IO RT
Data transmission rate	100 MBit/s max.

Accuracy

Resolution	
- Position	1...100 µm selectable
- Velocity	1 mm/s
Linearity ¹	< ± 0.01 % F.S. (minimum ± 50 µm)
Repeatability	< ± 0.001 % F.S. (minimum ± 2.5 µm)
Update time	dependent on stroke length
Process data	maximum 1 kHz
Temperature coefficient	< 15 ppm/°C
Ripple	< 5 µm
Hysteresis	< 4 µm

Operating conditions

Magnet speed	any
Operating temperature	0...+75 °C
Dew point, humidity	90% rel. humidity, no condensation
Ingress protection ²	profile: IP65, rod: IP67 if appropriate mating cable connector is correctly fitted
Shock test	100 g (single shock) IEC-Standard 60068-2-27
Vibration test	15 g/10...2000 Hz, IEC-Standard 60068-2-6 (resonance frequencies excluded)
EMC test	Electromagnetic emission EN 61000-4-6 (for industrial environments) Electromagnetic immunity EN 61000-4-3 the sensor meets the requirements of the EC directives and is marked with CE

Design, material

Diagnostic display	LED beside connector
<u>Profile model:</u>	
Sensor head	aluminum
Rod	aluminum
Position magnet	magnet slider or removable U-magnet
<u>Rod model:</u>	
Sensor head	aluminum
Rod	stainless steel 1.4301 / AISI 304
Pressure rating	350 bar, 700 bar peak
Position magnet	Ring- or U-magnets

Installation

Mounting position	any
Profile	adjustable mounting feet or T-Slot nut in bottom groove
U-magnet, removable	mounting plate and screws from antimagnetical material
Rod	threaded flange M18x1.5 or ¾" -16 UNF-3A
Position magnet	mounting plate and screws from antimagnetical material

Electrical connection

Connection type	2 x 4 pin M12 (d-coded); 1 x 4 pin M12 (a-coded)
Supply voltage	24 VDC (-15 / +20 %); UL Recognition requires an approved power supply with energy limitation (UL 61010-1), or Class 2 rating according to the National Electrical Code (USA) / Canadian Electrical Code.
- Polarity protection	up to -30 VDC
- Overvoltage protection	up to 36 VDC
Current consumption	typ. 110 mA
Ripple	≤ 0.28 Vpp
Electric strength	500 VDC (DC ground to machine ground)

¹ with position magnet # 251 416-2.

² The IP rating is not part of the UL recognition

Temposonics® RP – Profile design

Temposonics® RP offers modular construction, flexible mounting configurations and easy installation. Position measurement is contactless via two versions of position magnets.

- A sliding position magnet running in profile housing rails. Connection with the mobile machine part is via a ball jointed arm to taking up axial forces
 - A floating magnet, mounted directly on the moving part, travels over the profile at low distance.
- Its air-gap allows the correction of misalignments at installation.

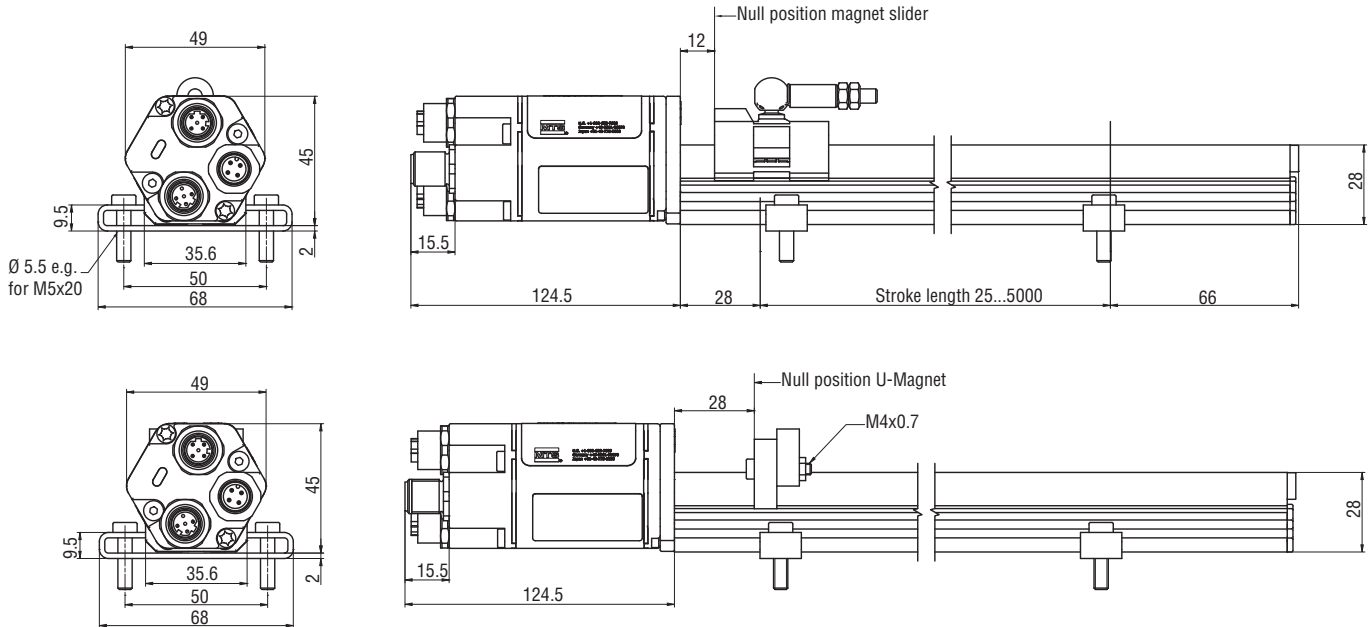

Connector wiring (connector view, sensor)

BUS On/Off	Pin	Cable	Function
 Female	1	YE	Tx+
	2	WH	Rx+
	3	OG	Tx-
	4	BU	Rx-

Supply	Pin	Cable	Function
 Connector	1	BN	+24 VDC (-15/+20 %)
	2	WH	n.c.
	3	BU	0 V (GND)
	4	BK	n.c.

All dimensions in mm

Standard position magnet included in delivery (see chapter accessories)

Position magnets

- Magnet slider S (Part No. 252 182)
- Magnet slider V (Part No. 252 184)
- U-magnet OD33 (Part No. 251 416-2)

Connection types

- 5 pin female connector M12, power supply (Part No. 370 677)
- 4 pin bus cable connector (Part No. 370 523)
- Cable connector 5 m M12-M12 (Part no. 530 064)
- Cable connector 5 m M12 -RJ45 (Part no. 530 065)

Temposonics® RH – High pressure design

Temposonics® RH with a pressure stainless steel flange and sensing rod is suitable for use in hydraulic cylinders and externally in all applications where space is a problem. Position measurement is via ring or U-magnets travelling along the sensing rod without any mechanical contact.

Advantage...

the completely operable sensor cartridge can be replaced for servicing easily without opening the fluid circuit.

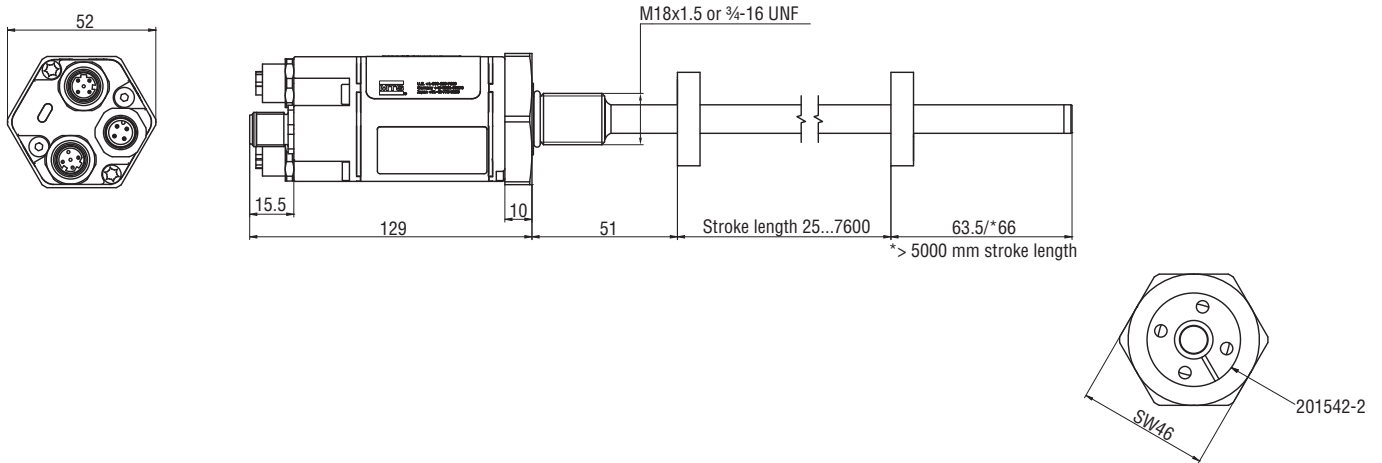

Position magnets (not included in delivery, please order separately)

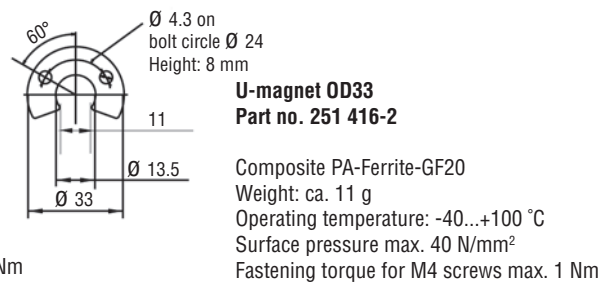
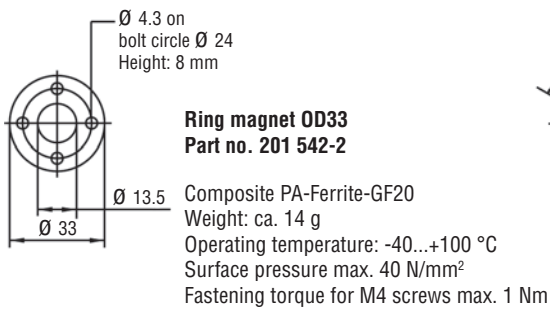

Other position magnets on request.

All dimensions in mm

Standard position magnet *not* included in delivery (see chapter accessories)

Position magnets

Ring magnet OD33 (Part No. 201 542-2)
Ring magnet OD25,4 (Part No. 400 533)
U-magnet OD33 (Part No. 251 416-2)

Connection types

5 pin female connector M12, power supply (Part No. 370 677)
4 pin bus cable connector (Part No. 370 523)
Cable connector 5 m M12-M12 (Part no. 530 064)
Cable connector 5 m M12-RJ45 (Part no. 530 065)

Temposonics® ordering information

R M D 5 8 1 U 4 Z

Specification

RP - Profile
RH - Rod

Design

Profile Temposonics® RP:

S - Magnet slider, joint at top
V - Magnet slider, joint at front
G - Magnet slider, joint at top, backlash free
M - U-Magnet, OD33

Rod Temposonics® RH:

M - Flange M18x1.5 (standard)
V - Flange M18x1.5 (Fluorelastomer housing-seal)
D - Flange M18x1.5 with bushing on rod end
R - Flange M18x1.5 with thread M4 at rod end
J - Flange M22x1.5, rod Ø 12.7 mm, 800 bar
S - Flange ¾" - 16 UNF-3A

Stroke length

Profile - 0025...5000 mm
Rod - 0025...7600 mm
Standard: see chart
Other length upon request.

Connection type

D58 - 2 x 4 pin M12 d-coded, 1 x 4 pin M12 a-coded

Supply voltage

1 - +24 VDC

Output

U401 - Profinet RT, Encoder Profile, 1 magnet
U402 - Profinet RT, MTS Profile, 1...19 magnets

Magnet number for multi-position measurement³

Z02...Z19 = 2...19 pcs

Profile

Delivery includes:

Sensor, position magnet, 2 mounting clamps up to 1250 mm + 1 clamp for each 500 mm. GDSML file on CD

Rod

Delivery includes:

Sensor and O-ring, GDSML file on CD
Please order separately: Magnets, connectors

Stroke length standard RP

Stroke	Ordering steps
≤ 500 mm	25 mm
500...2500 mm	50 mm
2500...5000 mm	100 mm

Stroke length standard RH

Stroke	Ordering steps
≤ 500 mm	5 mm
500...750 mm	10 mm
750...1000 mm	25 mm
1000...2500 mm	50 mm
2500...5000 mm	100 mm
> 5000 mm	250 mm

³ Note: Please specify magnet numbers for your sensing application and order separately

Temposonics®

Absolute, Non-Contact Position Sensors

R-Series SSI

Temposonics® RP and RH
Stroke length 25...7600 mm



Perfect data processing
0.5 µm

- Rugged industrial sensor
- Linear and absolute measurement
- LEDs for sensor diagnostics
- Non-contact sensing with highest durability
- Superior accuracy: Resolution up to 0.5 µm
- Linearity better 0.01 % F.S.
- Repeatability 0.001 % F.S.
- Direct SSI output, Gray/binary
- Synchronous measurement for real-time sensing

Sensor diagnostic display

Integrated LEDs (green/red) provide basic visual feedback for normal sensor operation and troubleshooting.



Green	Red	Description
ON	OFF	Normal function
ON	ON	Magnet not detected
ON	Flashing	wrong quantity of magnets
Flashing	ON	Sensor not synchronous*
Flashing	ON	Programming mode

*for synchronous measurement only

SSI (Synchronous Serial Interface)

The sensors fulfill all requirements of the SSI standard for absolute encoders. Its position value is encoded in a binary format and transmitted at high speed to the control device.

MTS offers the ideal solution for high dynamic applications by using different synchronisation modes. Corresponding to the application you can choose the following modes:

Async

In asynchronous mode the Temposonics® SSI sensor support the PLC with position values as fast as possible. The sensor works independently (free running mode).

Syn1

In synchronous mode 1 the output of the Temposonics® SSI sensor is matched to the data request cycle of the controller. The contouring error is as small as possible, the delay is equal to the cycle time of the sensor's stroke.

Syn2

The synchronous mode 2 is most suitable for applications where the polling cycle of the controller can be faster than the measurement cycle time of the Temposonics® SSI sensor. The values for the PLC will be oversampled up to 10 kHz. The delay is similar to the asynchronous mode.

Syn3

The function of the synchronous mode 3 is similar to Syn2 but here any delay will be compensated.

Timing diagram

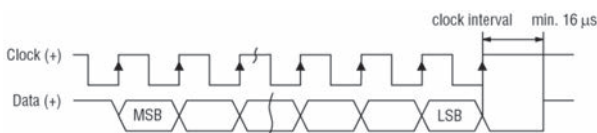

Logic diagram

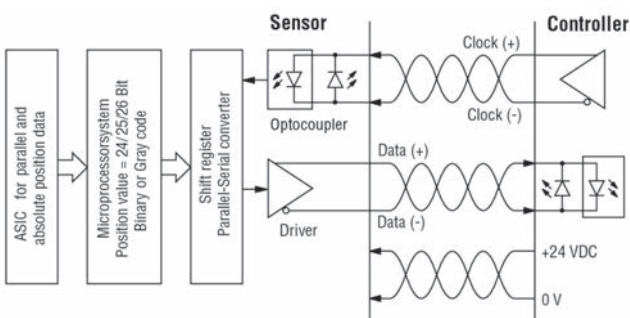

Sensor input

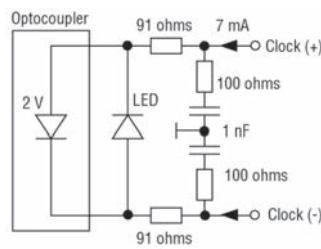

Sensor field programming

Temposonics® R-Series sensors are preconfigured at the factory by model code designation. If needed, MTS offers an external service tool for modifying sensor parameters inside the active electrical stroke (minimum 25 mm between set-points) via the standard connection cable. There is no need to open the sensors electronics.

USB-Programmer R-SSI

This hardware converter is required to communicate via USB-port of Windows PC to the sensor. Customized settings are possible by using a MTS programming software (CD-ROM) for:

- Data length
- Data format
- Resolution
- Measuring direction
- Synchronous / asynchronous measurement
- Offset, begin of the measurement range
- Alarm value (Magnet missing)
- Measurement filter
- Differential measurement: Distance between two magnets
- Speed measurement instead of position

Test sensor function permits a fast control of installed sensor. Its position values are shown in a diagram.



Programming-Kit, part no. 253 135-1

(PC-Programmer, Power supply, USB-Cable, Sensor-Cable, Software)

Windows sensor programming

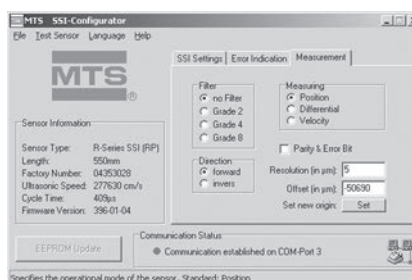

Technical Data

Input

Measured value	Position, position difference between 2 magnets, velocity, internal temperature
Stroke length	Profile 25...5000 mm / Rod 25...7600 mm

Output

Interface	SSI (Synchronous Serial Interface) - differential signal in SSI standard (RS 422)					
Data format	Binary or Gray, optional Parity and Errorbit and internal temperature					
Data length	8...32 bit					
Update time	Stroke length	300	750	1000	2000	5000 mm
	Measurement rate	3.7	3.0	2.3	1.2	0.5 kHz
Data speed	70 kBaud*...1 MBaud, depending on cable length:					
	Length	< 3	< 50	< 100	< 200	< 400 m
	Baud rate	1 MBd	< 400 kBd	< 300 kBd	< 200 kBd	< 100 kBd

Accuracy

Resolution	Position: 0.5 µm, 2 µm, 5 µm, 10 µm i.a. / velocity over 10 measured values: 0.1 mm/s (at 1 ms cycle time)
Linearity	< ± 0.01 % F.S. (minimum ± 40 µm)
	Option internal linearization
	Linearity tolerance:
Repeatability	<u>RP/RH</u> < 300 mm: typ. ± 15 µm, max. ± 25 µm, > 300...600 mm: typ. ± 20 µm, max. ± 30 µm
	> 600...1200 mm: typ. ± 30 µm, max. ± 50 µm
Temperature coefficient	<u>RP</u> 1200...3000 mm: typ. ± 45 µm, max. ± 90 µm, 3...5 m: typ. ± 85 µm, max. ± 150 µm
Hysteresis	< ± 0.001 % F.S. (minimum ± 2.5 µm)
	< 15 ppm/°C
	< 4 µm typical 2 µm

Operating conditions

Magnet speed	any
Operating temperature	-40 °C...+75 °C
Dew point, humidity	90% rel. humidity, no condensation
Ingress protection ¹	Profile: IP65, Rod: IP67, IP68 for cable outlet, RS: IP69K
Shock test	100 g single hit, IEC-Standard 60068-2-27
Vibration test	15 g / 10 - 2000 Hz, IEC-Standard 60068-2-6
	Option: Vibration resistant 30 g (av)
Standards, EMC test	Electromagnetic emission EN 61000-6-4
	Electromagnetic immunity EN 61000-6-2
	EN 61000-4-2/3/4/6, Level 3/4, Criterium A, CE-qualified

Design, material

Diagnostic display	LEDs beside connector
<u>Profile model:</u>	
Sensor head	Aluminum
Sensor stroke	Aluminum
Position magnet	Magnet slider or removable U-magnet
<u>Rod model:</u>	
Sensor head	Aluminum
Rod with flange	Stainless steel 1.4301 / AISI 304
Pressure rating	350 bar, 700 bar peak option: 800 bar, 1200 bar peak hydraulic rod
Position magnet	Ring magnets, U-magnets
- Differentiation measurement	Min. magnet distance 50 mm (in the range of 50...75 mm double linearity)

Installation

Mounting position	any orientation
Profile	movable mounting clamps or T-slot nuts M5 in base channel
U-magnet, removable	mounting plate and screws from antimagnetical material
Rod	threaded flange M18 x 1.5 or ¾" -16 UNF-3A
Position magnet	mounting plate and screws from antimagnetical material

Electrical connection

Connection type	7 pin connector M16 or cable outlet
Supply voltage	24 VDC (-15 / +20 %); UL Recognition requires an approved power supply with energy limitation (UL 61010-1), or Class 2 rating according to the National Electrical Code (USA) / Canadian Electrical Code.
- Polarity protection	up to -30 VDC
- Overvoltage protection	up to 36 VDC
Current drain	100 mA typical
Ripple (LF)	≤ 0.28 Vpp
Electric strength	500 VDC (DC ground to machine ground)

¹ The IP rating is not part of the UL recognition
* with standard monoflop of 16 µs

Stable profile design

Temposonics® RP offers modular construction, flexible mounting configurations and easy installation. Position measurement is contactless via two versions of permanent magnets.

- A sliding magnet running in profile housing rails. Connection with the mobile machine part is via a ball jointed arm to taking up axial forces.
- A floating magnet, mounted directly on the moving machine part, travels over the profile at a low distance. Its air-gap allows the correction of small misalignments at installation.

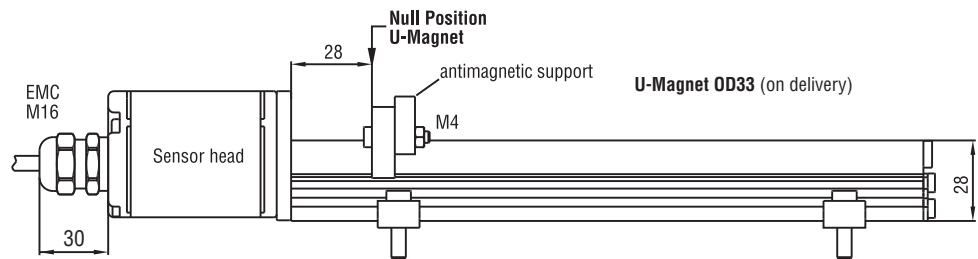
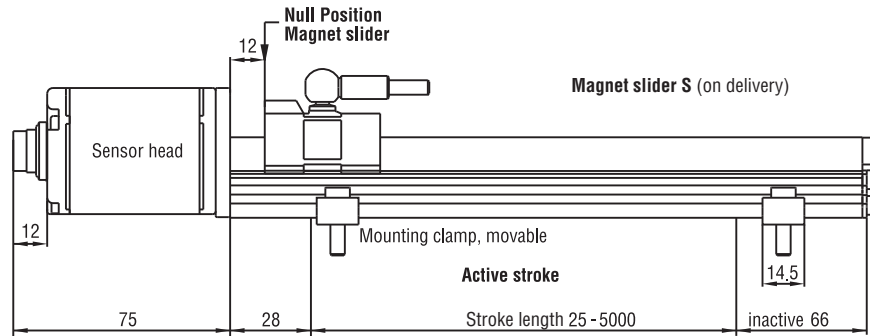
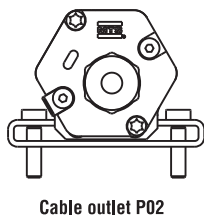
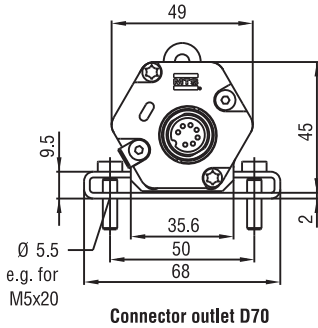

Wiring	Pin	Cable	Function
<p>Male insert sensor plug rear of cable connector</p>	1	grey	Data (-)
	2	pink	Data (+)
	3	yellow	Clock (+)
	4	green	Clock (-)
	5	brown	+24 VDC
	6	white	0 V (GND)
	7	do not connect	

All dimensions in mm

Standard position magnet included in delivery (see chapter accessories)

Position magnets

- Magnet slider S (part no. 252 182)
- Magnet slider V (part no. 252 184)
- U-magnet OD33 (part no. 251 416-2)

Connection types

- 7 pin female connector M16 (part no. 370 624)
- 7 pin female connector M16, 90° (part no. 560 779)

High pressure rod design

Temposonics® RH with a pressure-resistant stainless steel flange and sensing rod is suitable for use in hydraulic cylinders and externally in all applications where space is a problem. Position measurement is via ring or U-magnets travelling along the sensing rod without any mechanical contact.

Advantage...

the completely operable sensor cartridge can be replaced for servicing easily without opening the fluid circuit.

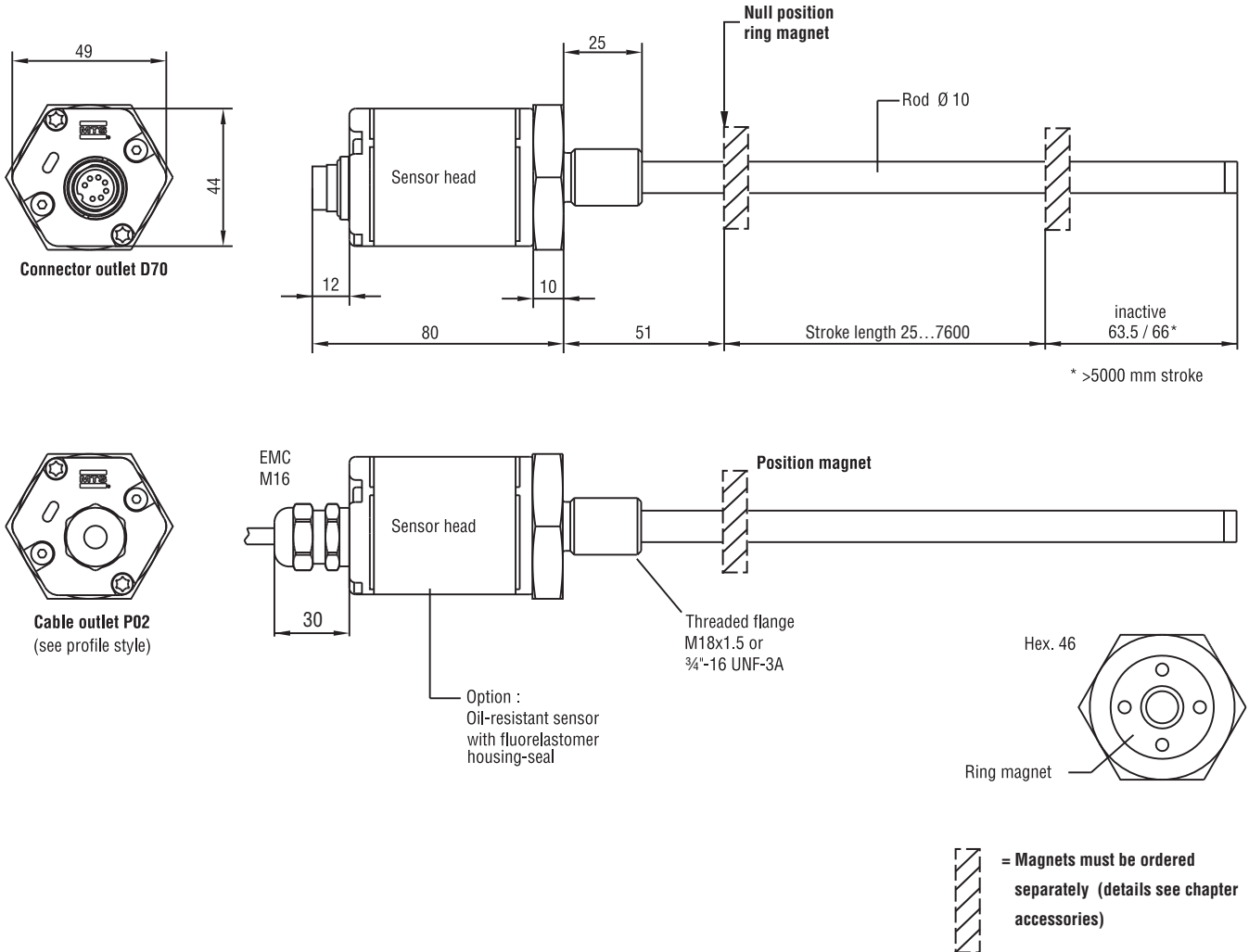

Standard position magnets (not included in delivery, please order separately)

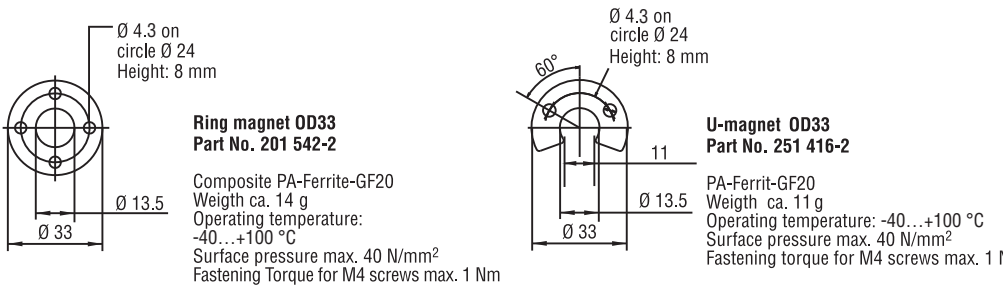

All dimensions in mm

Standard position magnet not included in delivery (see chapter accessories)

Position magnets

Ring magnet OD33 (part no. 201 542-2)
Ring magnet OD25,4 (part no. 400 533)
U-magnet OD33 (part no. 251 416-2)

Connection types

7 pin female connector M16 (part no. 370 624)
7 pin female connector M16, 90° (part no. 560 779)

Temposonics®

Sensor model

RP - Profile

RH - Rod

Design

Profile Temposonics® RP:

S - Magnet slider, joint at top

V - Magnet slider, joint at front

G - Magnet slider, joint at top, backlash free

M - U-magnet, OD33

Rod Temposonics® RH:

M - Flange M18 x 1.5 (Standard)

V - Flange M18 x 1.5 (Fluorelastomer housing-seal)

D - Flange M18 x 1.5 with bushing on rod end

R - Flange M18 x 1.5 with thread M4 at rod end

J - Flange M22 x 1.5, rod Ø 12.7 mm, 800 bar

S - Flange ¾" - 16 UNF - 3A

Stroke length

Profile - 0025...5000 mm

Rod - 0025...7600 mm

Standard: See chart

Other length upon request.

Stroke Length Standard RP	
Stroke length	Ordering steps
≤ 500 mm	25 mm
500...2500 mm	50 mm
2500...5000 mm	100 mm

Stroke Length Standard RH	
Stroke Length	Ordering Steps
< 500 mm	5 mm
500...750 mm	10 mm
750...1000 mm	25 mm
1000...2500 mm	50 mm
2500...5000 mm	100 mm
> 5000 mm	250 mm

Connection type

D70 - 7 pin male receptacle M16

P02 - 2 m PUR-cable w/o connector, option: P01 - P10 (1 - 10 m)

Supply voltage / Conditions of use

1 - +24 VDC

A - +24 VDC / vibration resistant (stroke length 25...2000 mm)

Output

S [1][2][3][4][5][6][7][8][9] = Synchronous Serial Interface

[1] Data length: **1** - 25 bit • **2** - 24 bit • **3** - 26 bit

[2] Output format **B** - Binary • **G** - Gray

[3] Resolution (mm): **1** - 0.005 • **2** - 0.01 • **3** - 0.05 • **4** - 0.1 • **5** - 0.02 • **6** - 0.002 • **8** - 0.001 • **9** - 0.0005

[4] Performance: **1** - Standard • **8** - Noise reduction filter (8 values) • **D** - No filter + error delay 10 cycles
G - Noise reduction filter (8 values) + error delay 10 cycles • **K** - Peak reduction filter (8 values)
N - Peak reduction filter (8 values) + error delay 10 cycles

[5][6] Signal options: **00** - Measuring direction forward
01 - Measuring direction reverse
02 - Measuring direction forward, synchronised measurement
05 - Measuring direction forward, Bit 25 = Alarm, Bit 26 = Parity even
16 - Measuring direction forward, internal linearization
99 - for optional further combinations (use next fields **[7],[8],[9]**)

[7] Measurement contents **1** - Position • **2** - Differential • **3** - Velocity • **4** - Position + temperature (only with data length = 24 bit)
5 - Differential + temperature (only with data length = 24 bit) • **6** - Velocity + temperature (only with data length = 24 bit)

[8] Direction and sync. mode **1** - Forward async • **2** - Forward sync1 • **3** - Forward sync2 • **4** - Forward sync3 • **5** - Reverse async • **6** - Reverse sync1
7 - Reverse sync2 • **8** - Reverse sync3

[9] Internal linearization & communication diagnostics **0** - No further option • **1** - Linearity Correction Option • **2** - Additional alarm bit + parity even bit (not available for temperature output, only data length 26 bit) • **4** - Additional alarm bit + parity even bit and Linearity Correction Option (not available for temperature output, only data length 26 bit)

Included in delivery profile model: Sensor, position magnet, 2 mounting clamps up to 1250 mm + 1 clamp for every additional 500 mm.

Included in delivery rod model: Sensor and O-ring. Magnets must be ordered separately. Use signed magnets for sensors w/LCO

Accessories page 67 and following.

MOUNTING / INSTALLATION RP + RH

Flexible installation in any position

Profile model

Normally, the sensor is firmly installed - fixed on a straight surface of the machine with movable mounting clamps or M5 screws in base channel (2 mounting clamps up to 1250 mm + 1 clamp for every 500 mm) - whilst the magnet is mounted at the mobile machine part.

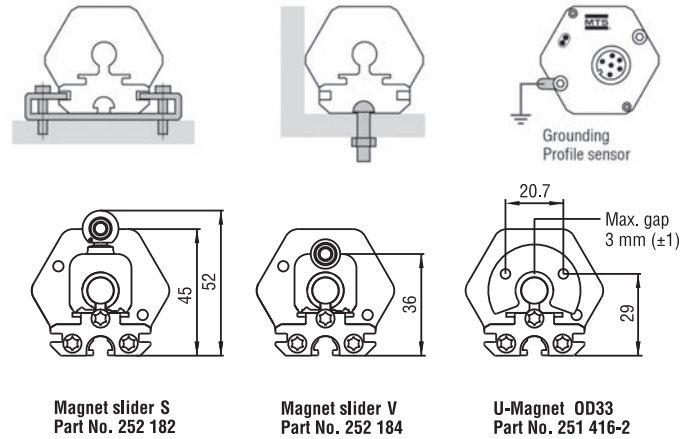

Rod model

Mount the sensor via flange thread or a hex nut. If possible, non-magnetizable material should be used for mounting support (dimensions as shown). With horizontal mounting, longer sensors (from 1 meter) must be provided with mechanical support.

Hydraulic sealing

Recommended is sealing of the flange facing with O-ring (e.g. 22.4 x 2.65) in a cylinder cover nut or an O-ring 15.3 x 2.2 in undercut.

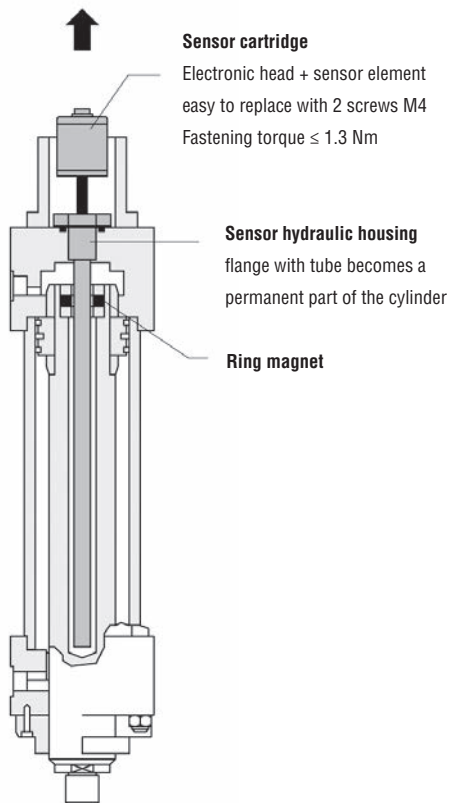

Minimum assembly distance

1. Non-magnetizable material

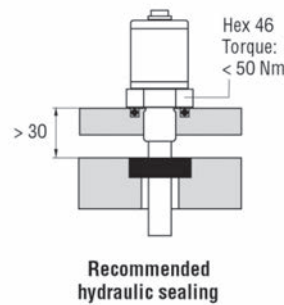

2. Magnetizable material

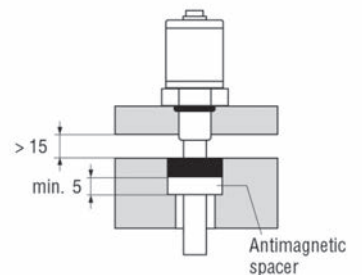

Included in delivery:
O-ring 15,3 x 2,2
See ISO 6149-1

Cylinder installation

When used for direct stroke measurement in fluid cylinders, the sensor's high pressure, stainless steel rod installs into a bore in the piston head/rod assembly as illustrated. That guarantees a longlife and trouble-free operation - independent of used hydraulic fluid.

The sensor cartridge can be removed from the flange and rod housing while still installed in the cylinder. This procedure allows quick and easy sensor cartridge replacement, without the loss of hydraulic pressure.

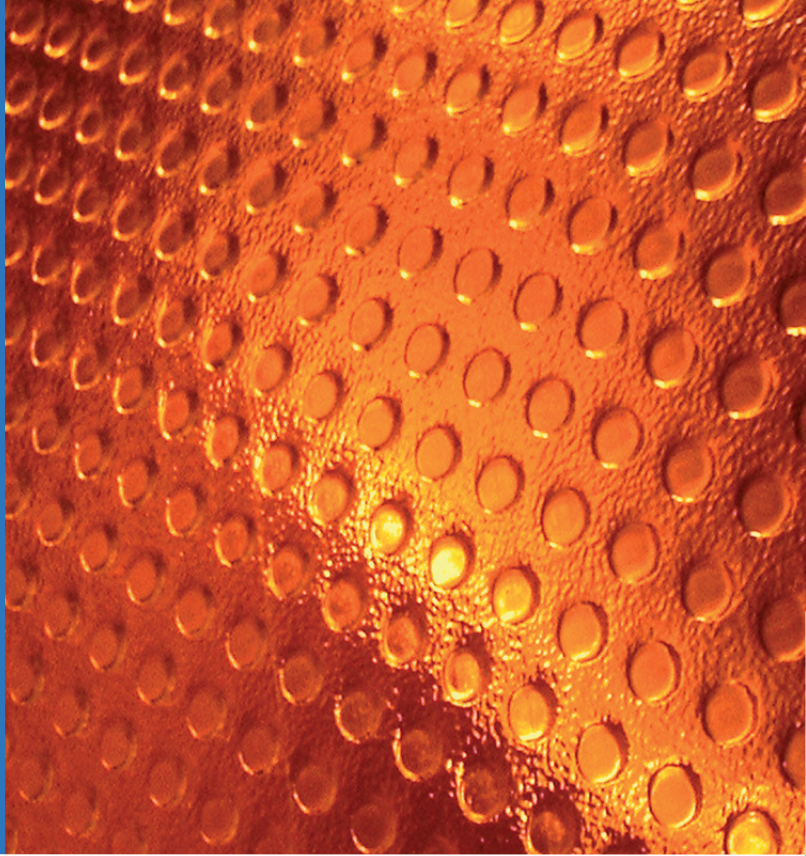

Temposonics®

Absolute, Non-Contact Position Sensors

R-Series Rod Model RF

Temposonics® RF
Stroke length 100...20.000 mm



Flexible sensor

- Rugged industrial sensor
- Linear and absolute measurement
- LEDs for sensor diagnostics
- Contactless sensing with highest durability
- Superior accuracy: Linearity better 0.02 % F.S.
- Repeatability 0.001 % F.S.
- Direct output for position and velocity
- Analog / SSI / CANbus / Profibus-DP / EtherCAT / Ethernet/IP™ / Powerlink / Profinet
- Multi-position measurement: max. 20 positions with 1 sensor
- Cost-effective shipment for long measuring length

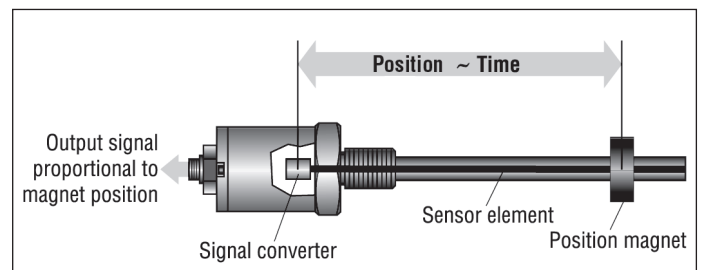

Temposonics® RF with compact housing and broad range of stroke length are user-friendly, modular sensors ideal for harshest continuous operations in the automation industry.

The sensor head accommodates the complete electronic interface with active signal conditioning. Double encapsulation ensures high operating safety and optimum EMC protection. The passiv position transmitter, a permanent magnet, drives contactlessly over the sensors stroke and starts measuring through the housing wall.

Optimized on high accuracy, engaged the sensor linear measuring displacements up to 20 meters and can be also used for linear measurements on selected radiuses.

Technical data

Input

Measured variables	- Position - Velocity - Multi-position measurement max. 20 positions (CANbus, Profibus, EtherCAT, Ethernet/IP™, Powerlink, Profinet)
Stroke length	100...20.000 mm

Output

Interfaces	Analog, SSI, CANbus, Profibus-DP, EtherCAT, Ethernet/IP™, Powerlink, Profinet
------------	---

Accuracy

Resolution	Output dependent
Linearity	< ±0.02 % F.S. (Minimum ±100 µm)
Repeatability	< ±0.001 % F.S. (Minimum ±2.5 µm)
Hysteresis	< 4 µm

Operating conditions

Magnet movement velocity	Any
Operating temperature	-40...+75 °C
Dew point, humidity	90% rel. humidity, no condensation
Ingress protection	IP30 (IP65 rating only for professional mounted guide pipe IP65 and if mating connectors are correctly fitted)
Shock test	100 g (single shock IEC-Standard 60068-2-27)
Vibration test	5 g / 10...150 Hz IEC-Standard 60068-2-6
Standards, EMC test	Electromagnetic emission EN 61000-6-4 Electromagnetic immunity EN 61000-6-2 EN 61000-4-2/3/4/6, Level 3/4, Criterium A, CE qualified ¹

Design, Material

Diagnostic display	LEDs beside connector
Sensor electronics housing	Aluminum
Sensor stroke	Stainless steel conduct with Teflon® coating
Position magnet	Ring- or U-magnet

Electrical connection

Connection type	Connector or cable outlet (output dependent)
Supply voltage	24 VDC (-15 / +20 %)
- Polarity protection	Up to -30 VDC
- Overvoltage protection	Up to 36 VDC
Current drain	100 mA typical
Ripple	< 0.28 Vpp
Electric strength	500 VDC (DC ground to machine ground)

Info:
For detailed technical data and electrical connection for the outputs please see data sheets: R-Series Analog, SSI, CANbus, Profibus, EtherCAT, Ethernet/IP™, Powerlink, Profinet

¹The conformity is fulfilled, assumed the wave guide of the sensor is embedded in an EMC-sealed and grounded housing.

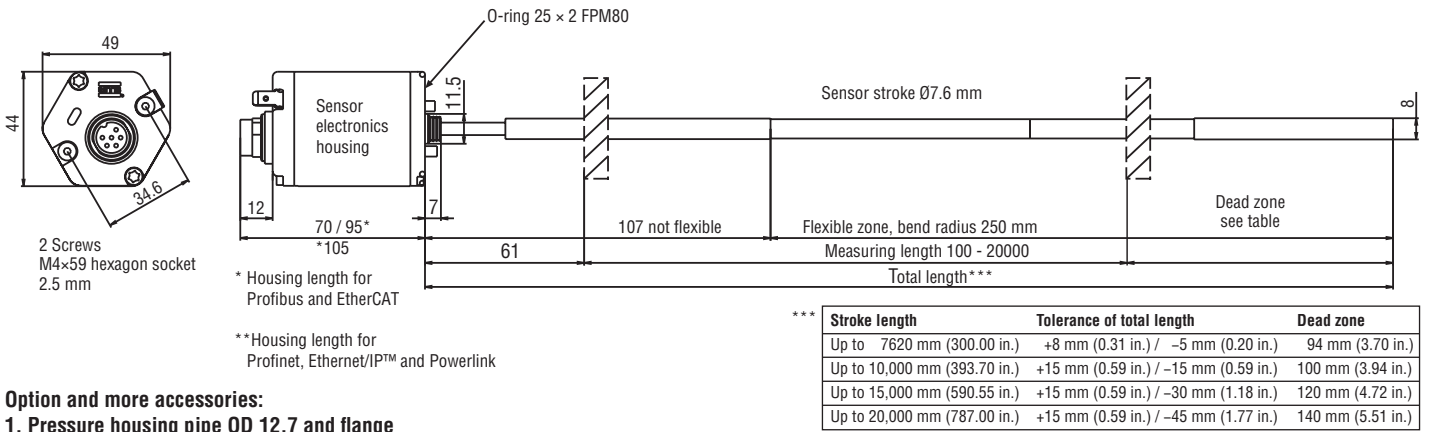

Option and more accessories:

1. Pressure housing pipe OD 12.7 and flange

Pressure housing pipe with flange is designed specifically for Temposonics® RF. It provides protection from high pressures, as found in hydraulic cylinders, up to 350 bar static, 700 bar peak. Typically, a bore 18 mm is used to match the large ring magnet.

2. Flexible RF profile FFP

See "Product Flash RF Profile" (Document Part No.: 551 442) for further information

3. Flange M18x1,5 Part No. 402 704

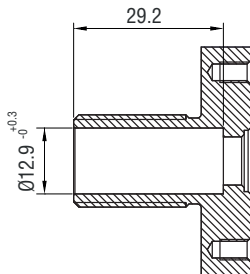

Drawing pressure housing pipe

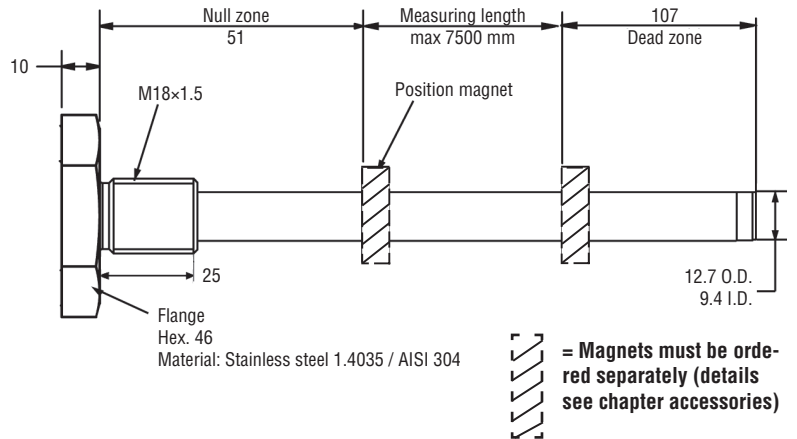

Position magnets (not included in delivery, please order separately)

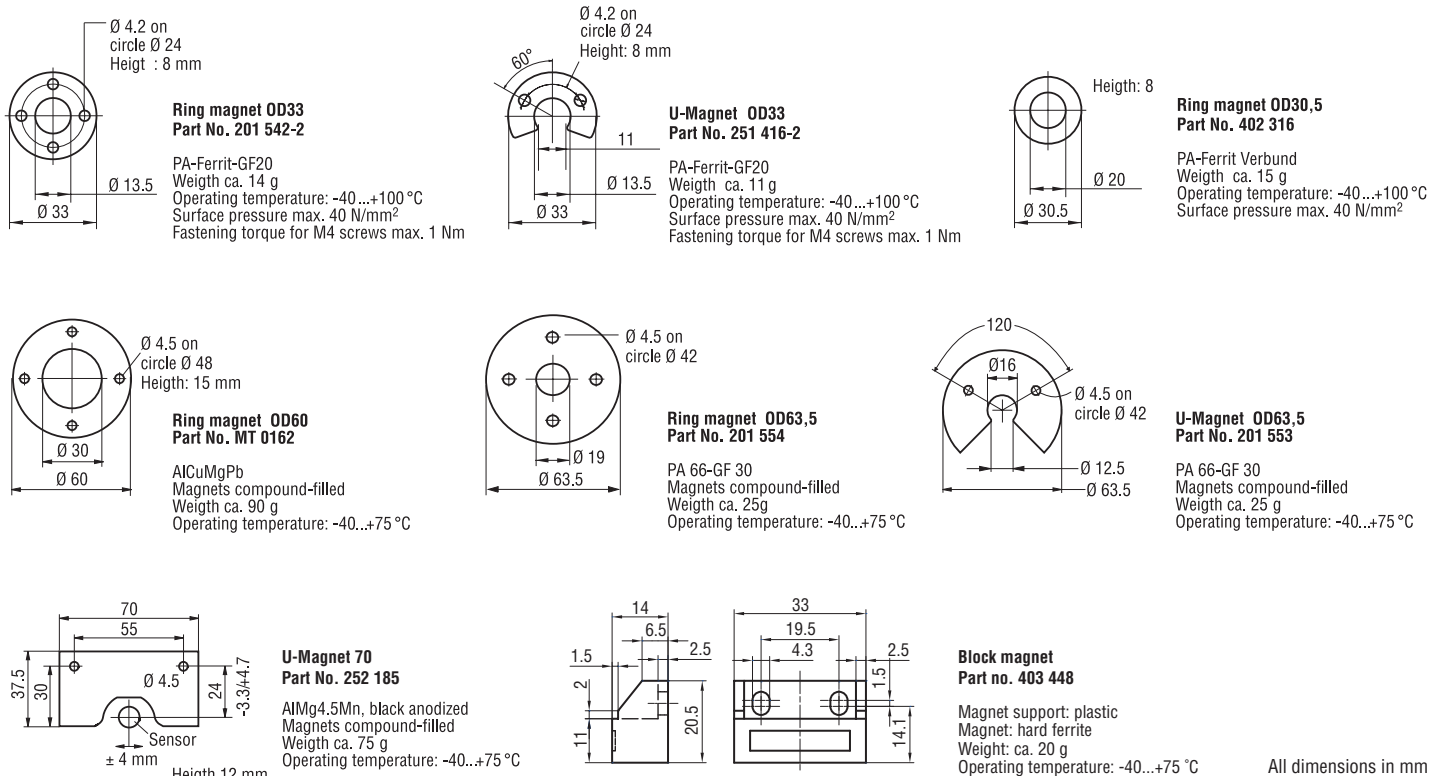

Standard position magnet not included in delivery (see chapter accessories)

Position magnets
Ring magnet OD33 (part no. 201 542-2)
U-magnet OD33 (part no. 251 416-2)

Connection types
Connector or cable outlet output dependent

Sensor Installation

Mounting of sensor electronics housing requires the use of 2 non-ferrous screws M4x59. Long sensors require a guide pipe support (inside diameter of 9.4 mm) of non-magnetizable material, straight or bent to the desired shape.

For easy installation the sensor can be supplied with a hex 46 flange (accessory) bored for above mounting screws.

Optional you can order a pressure housing pipe OD 12.7 mm with flange up to max 7500 mm stroke length.

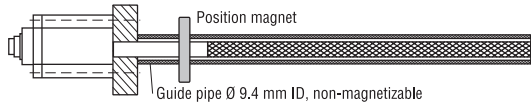

Straight measurements

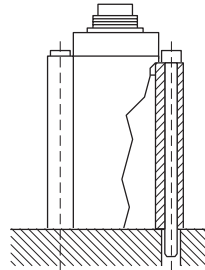
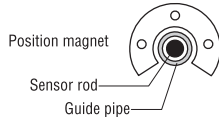

Note
A flexible sensor requires supports or anchoring to maintain proper alignment between sensor rod and the magnet, otherwise the sensor output signal can be interfered or lost.

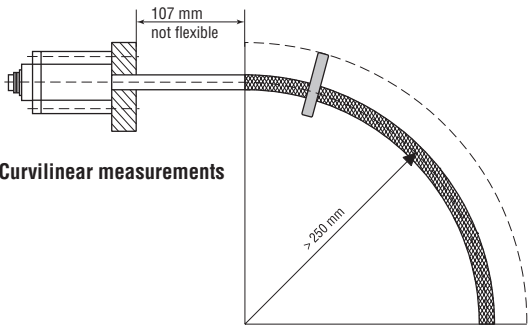

Curvilinear measurements

Note
Bend radius 250 mm,
radius for shipping 400 mm

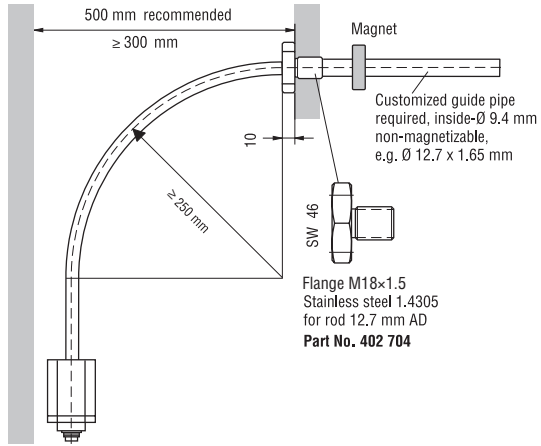

Required for substitute sensors mounted on flange Part No. 401 035:
Use 2 Screws 8-32 x 2.35 Part No. 402 617 which supplied as attachment with each sensor.
The red rubber seal between sensor head and sensor stroke slit carefully and remove.

Temposonics®



Model

RF = Flexible sensor stroke

Design

C - Basic sensor

M - Flange M18×1.5

S - Flange ¾" – 16 UNF – 3A

Messlänge

00100...20.000 mm

Up to 1000 in 50 mm steps, up 1000 in 250 mm steps

Further parameter

See data sheets R-Series according to the required output

Analog / SSI / CANbus / Profibus / EtherCAT / Ethernet/IP™ / Powerlink / Profinet

Magnets and accessories (Please order separately)

Accessories

	Part No.
Ring magnet OD33, standard	201 542-2
U-magnet OD33 251	416-2
Ring magnet OD30.5	402 316
Ring magnet OD60	MT 0162
Ring magnet OD63.5	201 554
U-magnet OD63.5	201 553
U-magnet 70	252 185
Block magnet	403 448
Flange M18×1.5 for pressure housing pipe 12.7 mm	402 704

Flexible RF Profile HFP

See "Product Flash RF Profile"

(Document Part No.: 551 442) for further information

Pressure housing pipe (Please order separately)

Temposonics®



Model

HD = Pressure housing pipe 12.7 mm with flange for Temposonics® RF M18×1.5

Stroke length

255...7500 mm

Standard: See chart

Stroke Length Standard RF	
Stroke length	Ordering steps
< 1000 mm	50 mm
1000 - 5000 mm	100 mm
5000 - 10000 mm	250 mm
10000 - 15000 mm	500 mm
> 15000 mm	1000 mm

CAN YOU IMAGINE... a hillside threatened by land slipping. An 18 m long MTS Temposonics® sensor detects even smallest ground movements and can predict land slipping. In other words: it is able to prevent catastrophies.

Intelligence, high speed and utmost precision. High-accuracy MTS sensors offer all possibilities for an increase of the efficiency and value of your products.

Innovation: The invention of the magnetostrictive measurement method was only a first step. MTS Sensors is continuously striving to enhance their product functionality and to find new fields of application for magnetostriction technology.

Flexibility: MTS customer-oriented engineering means that the technology can be used both for standard and individual product solutions. Whatever the requirements on length, size, pressure resistance or output may be, MTS sensors are versatile and flexible.

Reliability: Integrate and forget them. Based on the magnetostrictive technology, high-resolution sensor operation is completely contactless and free of wear. Recalibration is omitted. The absolute measuring principle is a warranty that the sensors are immediately ready for operation also after trouble.

Quick reaction: MTS delivery times are extremely short. Delivery within two weeks after ordering supports quick realization of your project. In urgent cases, MTS has the capacity to complete production and shipment even within 48 hours.

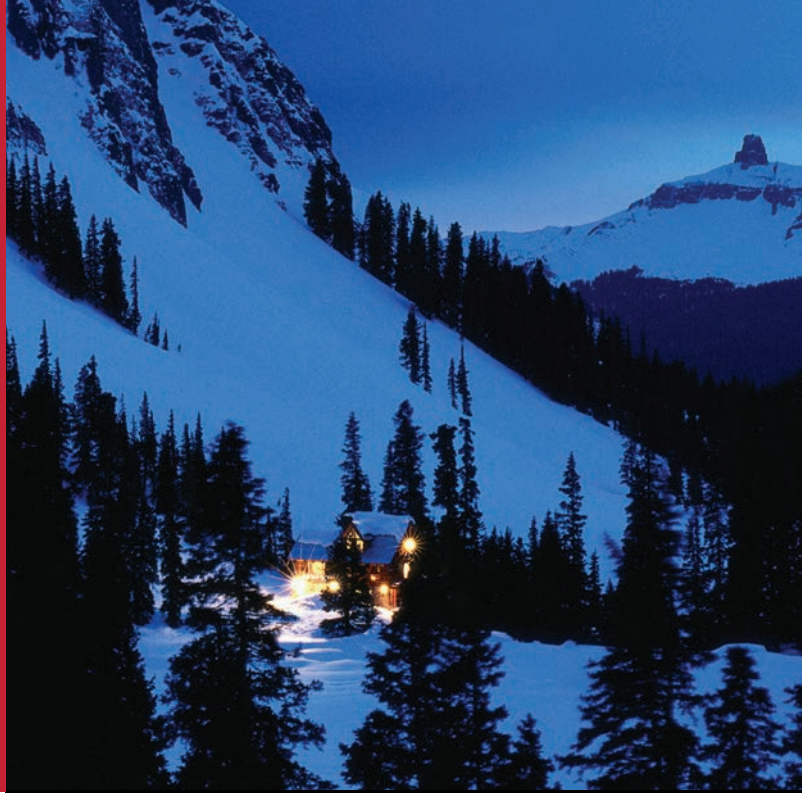

Temposonics®

Absolute, Non-Contact Position Sensors

R-Series Rod Model RD4

Temposonics® RD4
Stroke length 25...5000 mm



**Compact sensor for
hydraulic cylinders
and machine manufacturing**

- Rugged industrial sensor
- Linear and absolute measurement
- LEDs for sensor diagnostics
- Non-contact sensing with highest durability
- Superior accuracy: Linearity better 0.02 % F.S.
- Repeatability 0.001 % F.S.
- Direct output for position and velocity
- Analog / SSI / CANbus / Profibus-DP / EtherCAT / Ethernet/IP™ / Powerlink / Profinet
- Multi-position measurement: max. 20 positions with 1 sensor

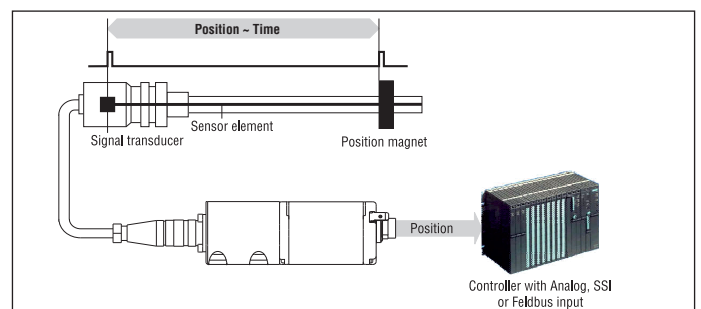

Temposonics® RD4 the extremely robust sensor, ideal for continuous operation under harshest industrial conditions is completely modular in mechanic and electronic design. A rod-shaped sensor housing protects the sensing element. The sensor head accommodates the complete modulare electronic interface with active signal conditioning. Double encapsulation ensures high operation safety and optimum EMC protection.

The position transmitter, a permanent magnet fixed at the mobile machine part, drives contactlessly over the sensor's stroke and starts measuring through the housing wall.

Temposonics® RD4 sensors were designed for installation into hydraulic cylinders, specifically for use in standard clevis head cylinders or any space limited cylinder application. They consist of:

- The pressure proof stainless steel sensor rod with fitting or threaded flange, which protects the sensing element in which the measurement signal arises. It fits into the bored piston rod.
- The external industrial housing (IP67) which accommodates the modular electronic interface with active signal conditioning. The sensor electronics is connected to the basic-sensor via side or bottom cable entry.

Technical data

Input	
Measured variables	- Position - Velocity - Multi-position measurement max. 20 positions (CANbus, Profibus, EtherCAT, Ethernet/IP™, Powerlink, Profinet)
Stroke length	25...5000 mm
Output	
Interfaces	Analog, SSI, CANbus, Profibus-DP, EtherCAT, Ethernet/IP™, Powerlink, Profinet
Accuracy	
Resolution	Output dependent
Linearity	$< \pm 0.02\%$ F.S. (Minimum $\pm 50\ \mu\text{m}$) ¹ $< \pm$
Repeatability	0.001 % F.S. (Minimum $\pm 2.5\ \mu\text{m}$) $< 4\ \mu\text{m}$
Hysteresis	Analog: 0.01 % F.S. / Digital: $< \pm 10\ \mu\text{m}$
Ripple/Jitter	
Operating conditions	
Magnet speed	Any
Operating temperature	-40 °C...+75 °C
Dew point, humidity	90% rel. humidity, no condensation
Ingress protection	Sensor electronics IP67 (with professional mounted housing and connectors) Measuring rod with connecting cable for side cable entry IP65 Measuring rod with single wires and flat connector with bottom cable entry IP30 100 g
Shock test	(single shock IEC-Standard 60068-2-27)
Vibration test	10 g / 10 - 2000 Hz IEC-Standard 60068-2-6
Standards, EMC test ²	Electromagnetic emission EN 61000-6-4 Electromagnetic immunity EN 61000-6-2 EN 61000-4-2/3/4/6, Level 3/4, criterium A
Design, material	
Diagnostic display	LED beside connector
Sensor electronics	Aluminum
Measuring rod with flange	Stainless steel 1.4301 / AISI 304
Operating pressure	350 bar, (700 bar peak) for hydraulic rod Ring
Position magnet	magnets
Electrical connection	
Connection type	Connector or cable outlet (output dependent) 24
Supply voltage	VDC (-15 / +20 %)
- Polarity protection	up to -30 VDC
- Overvoltage protection	up to 36 VDC
Current drain	100 mA typical
Ripple	$\leq 0.28\ \text{V}_{\text{pp}}$
Electric strength	500 VDC (DC ground to machine ground)

¹ For rod style "S" the linearity deviation can be higher in the first 30 mm (1.2 in.) of stroke length

² Measuring rod and connecting cable mounted inside metal housing

Info:

For detailed technical data and electrical connection for the outputs please see data sheets: R-Series Analog, SSI, CANbus, Profibus, EtherCAT, Ethernet/IP™, Powerlink, Profinet

Electronics with side cable entry for the measuring rod

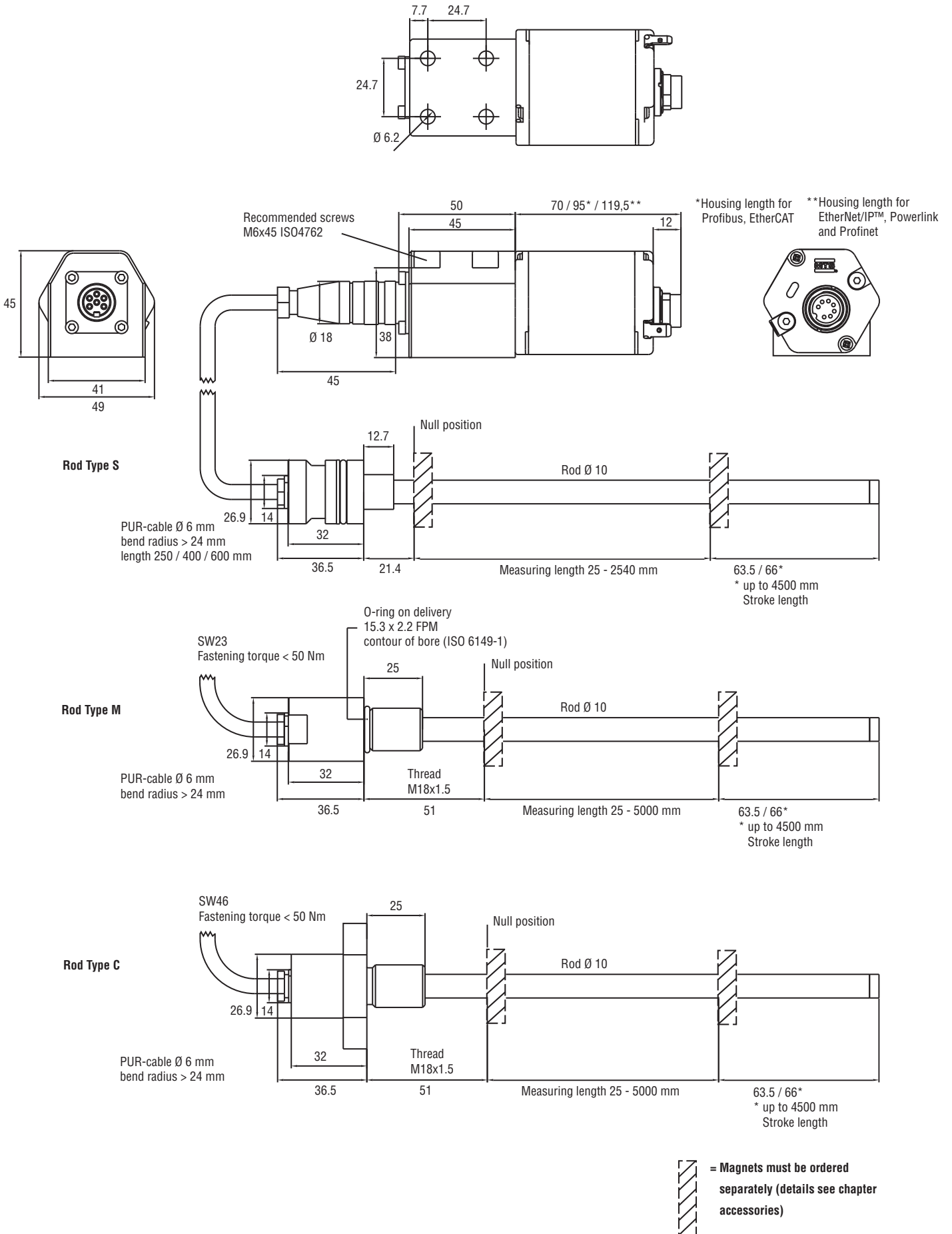

All dimensions in mm

Electronics with bottom cable entry for the measuring rod

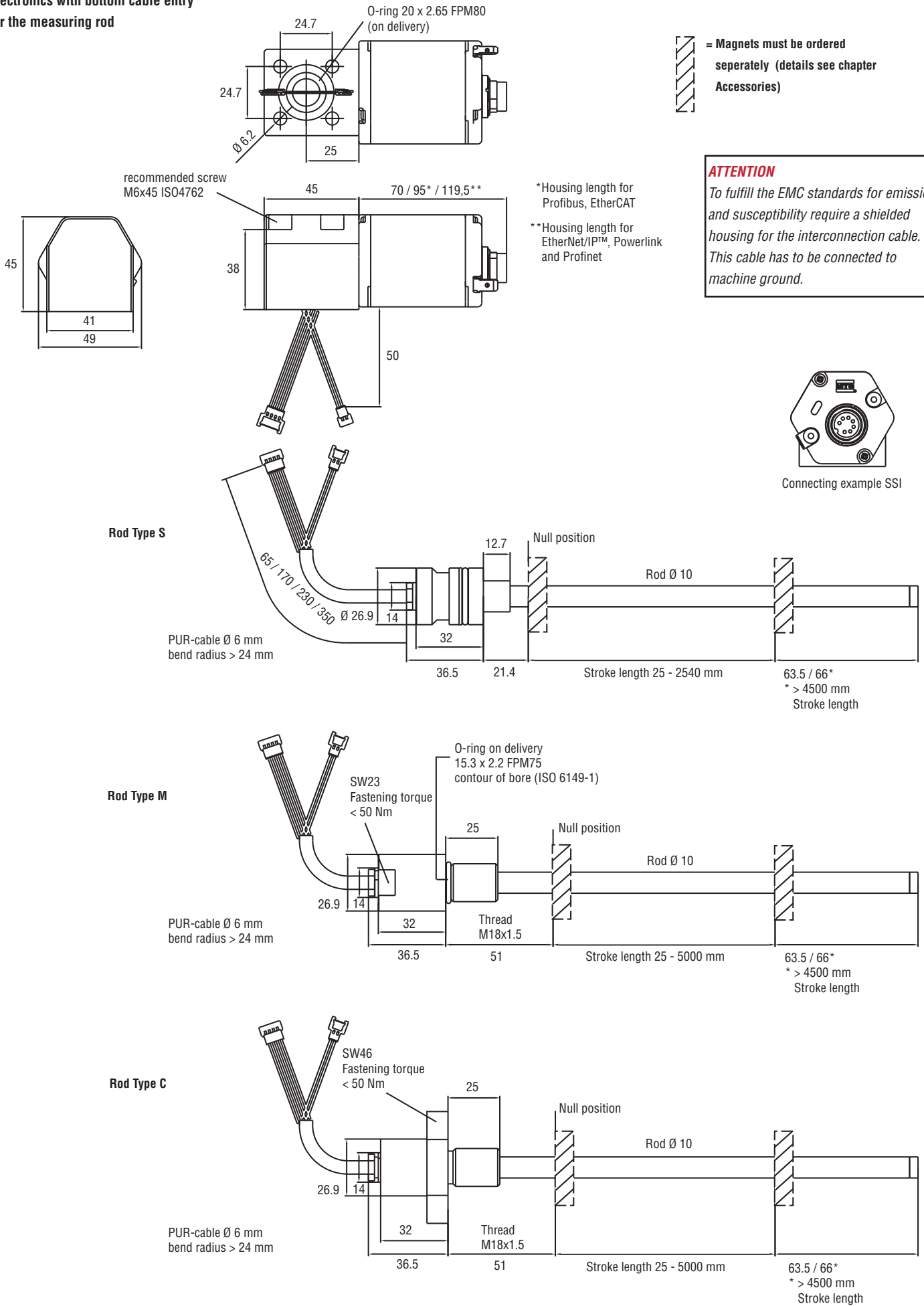

All dimensions in mm

Sensor installation with fitting flange »S«

Cylinder mounting

For installation in hydraulic cylinders, we recommend the sensor system consisting of the rod and the mounting flange, and the B type electronics.

Install the rod using the fit and seal it off by means of the O-ring and the supporting ring. Block the rod using a shoulder screw.

The adaptor plate of the separate electronics housing facilitates mounting on the outside of small cylinders. Advantage of this version: Connection to the measuring rod is via the bottom of the housing. Thus the sensor system is fully encapsulated and protected against external disturbances.

When installing the cylinder, please note:

- The position magnet should not grind over the measuring rod.
- The bore in the piston rod is dependent on the hydraulic pressure and the piston's velocity. The minimum drilling should be 13 mm. Do not exceed the peak pressure.
- The measuring rod should be protected against wear.

Mounting ring magnet

Mount the magnetic with the non-magnetic material for entrainment, screws, spacers, etc..

Mounting example fitting flange »S« and sensor electronics with bottom cable entry

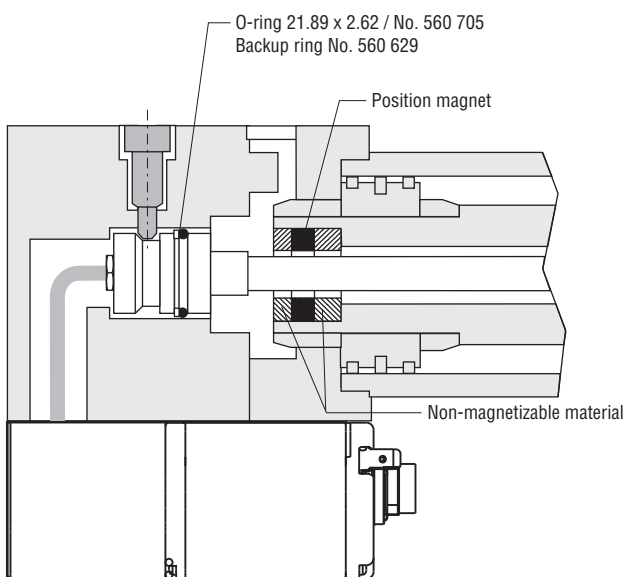

Minimum installation dimensions for magnetizable material

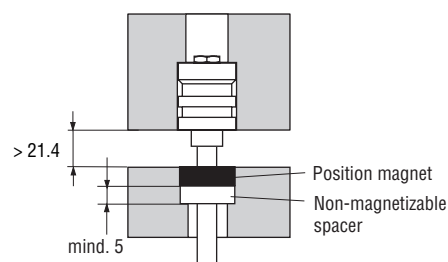

Bore in cylinder \varnothing 13...17 mm to push single wires with flat connector through.

Selection of position magnets (not included in delivery, please order separately)

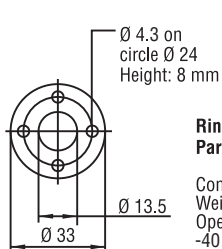

Ring magnet OD33
Part No. 201 542-2

Composite PA-Ferrite-GF20
Weigh ca. 14 g
Operating temperature:
-40...+100 °C
Surface pressure max. 40 N/mm²
Fastening Torque for M4 screws max. 1 Nm

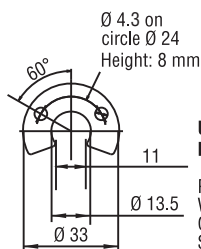

U-magnet OD33
Part No. 251 416-2

PA-Ferrit-GF20
Weigh ca. 11 g
Operating temperature: -40...+100 °C
Surface pressure max. 40 N/mm²
Fastening torque for M4 screws max. 1 Nm

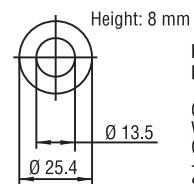

Ring magnet OD25,4
Part No. 400 533

Composite: PA-Ferrite
Weigh ca. 10 g
Operating temperature:
-40...+100 °C
Surface pressure max.
40 N/mm²

All dimensions in mm

Standard position magnet not included in delivery (see chapter accessories)

Position magnets

Ring magnet OD33 (part no. 201 542-2)
Ring magnet OD25,4 (part no. 400 533)
U-magnet OD33 (part no. 251 416-2)

Connection types

Connector or cable outlet output dependent

Mounting example fitting flange »S« and sensor electronics with side cable entry

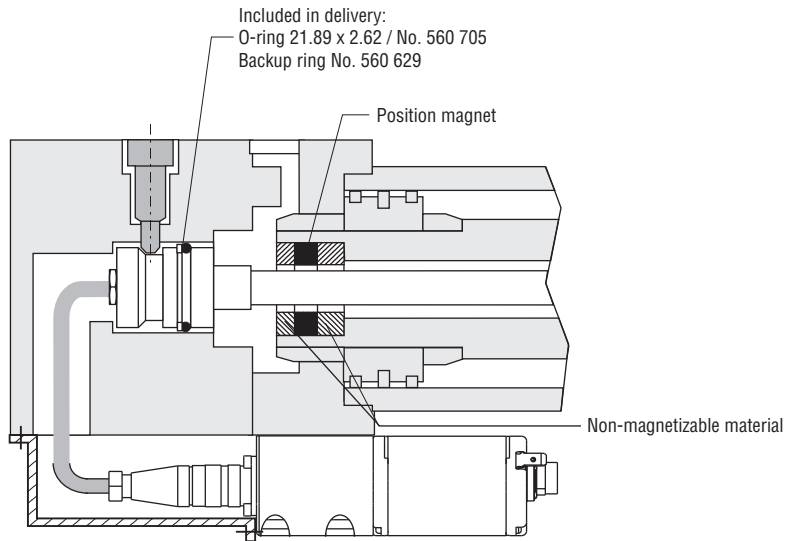

Mounting detail: Setscrew 8 M6 - ISO 7379 with internal hexagon

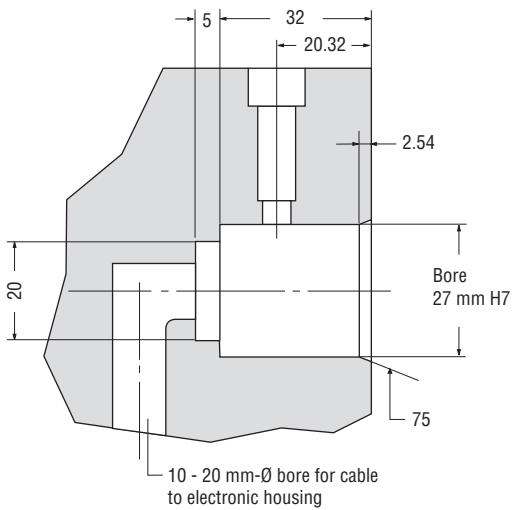

Detail: Fitting flange

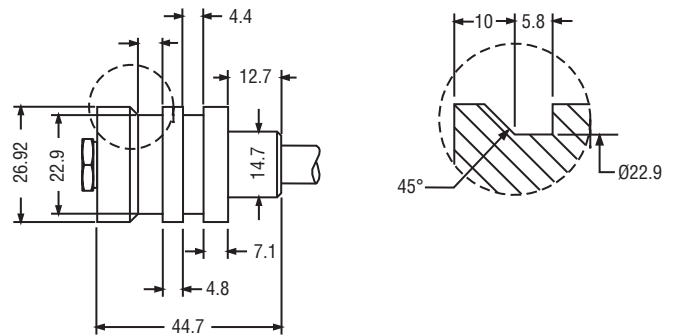

ATTENTION

To fulfill the EMC standards for emission and susceptibility the electronic housing has to be connected to machine ground.

Sensor installation with fitting flange »M« and »C«

Rod

The sensor's pipe will be fixed via the threaded flange M18 x 1.5.
Mounting should be with non-magnetizable material. If using magnetizable material please necessarily follow the displayed installation dimensions.

Mounting example fitting flange »M«

Sealing results from the provided O-ring 15.3x2.2 mounted in the undercut.

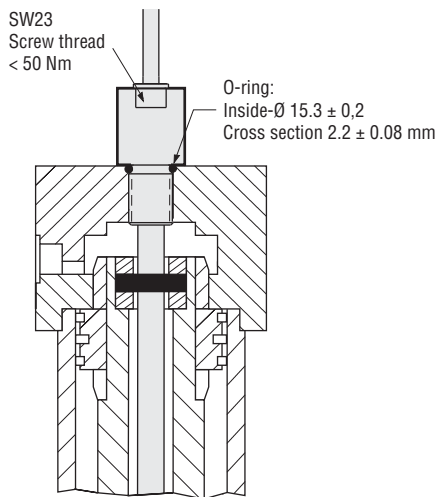

Mounting example fitting flange »C«

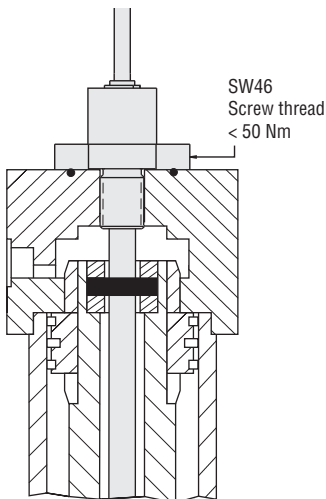

Hydraulic sealing

Recommended is a sealing of the flange facing with O-ring (e.g. 21.89 x 2.62) in a cylinder cover nut or an O-ring in undercut.

Cylinder mounting

- The position magnet should not grind over the measuring rod.
- The bore in the piston rod is dependent on the hydraulic pressure and the piston's velocity. The minimum drilling should be 10 mm. Do not exceed the peak pressure.
- The measuring rod should be protected against wear.
- Pressure sealing is defined by cylinder manufacturer

Detail screwing bore

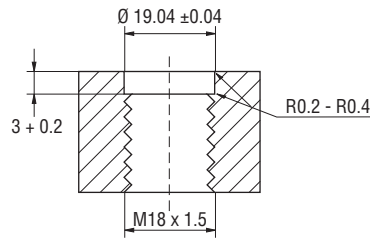

Alternative screwing bore:
See ISO 6149-1

Position magnet

For accurate position measurement mount the magnet with non-magnetizable fastening material (screws, supports etc.).

Non-magnetizable material

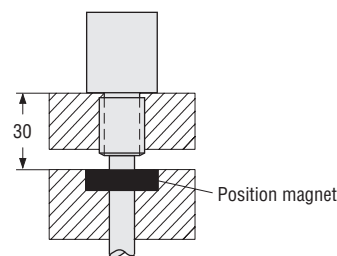

Magnetizable material

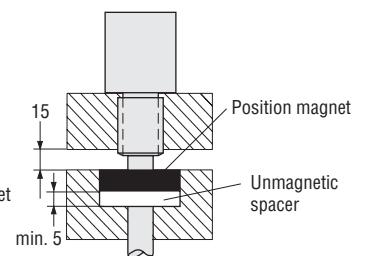

Temposonics® RD4



Sensor rod style

- S** – Fitting flange
- M** – Threaded flange M18 x 1.5, HEX23
- C** – Threaded flange M18 x 1.5, HEX46

Integral cable of sensor rod

For side cable entry:

- D1** - PUR-cable, length 250 mm
- D2** - PUR-cable, length 400 mm
- D3** - PUR-cable, length 600 mm

For bottom cable entry:

- R2** - Single wires with flat connector, length 65 mm
- R4** - Single wires with flat connector, length 170 mm
- R5** - Single wires with flat connector, length 230 mm
- R6** - Single wires with flat connector, length 350 mm

Sensor electronics

- S** - Side cable entry
- B** - Bottom cable entry

Stroke length

- Flange M, C: 0025...5000 mm
- Flange S: 0025...2540 mm
- Standard: See chart

Further parameter

See data sheets R-Series according to the required output Analog / SSI / CANbus / Profibus / EtherCAT / EtherNet/IP™ / Powerlink / Profinet

Magnets and Accessories must be ordered separately.

Description	Part No.
Ring magnet OD33, standard	201 542-2
U-magnet OD33	251 416-2
Ring magnet OD 25.4 mm	400 533
Ring magnet OD 17.4 mm	401 032
Connectors and cables see data sheet R-Series	
Spare parts	
O-ring 15.3 x 2.2 FPM 75	401 133
O-ring 21.89 x 2.62 PFPM 75	560 705
Backup ring	560 629
O-ring 20 x 2.65 FPM 80	561 435

Stroke Length Standard RD4	
Stroke length	Ordering steps
< 500 mm	5 mm
500...750 mm	10 mm
750...1000 mm	25 mm
1000...2500 mm	50 mm
> 2500 mm	100 mm

Temposonics®

Absolute, Non-Contact Position Sensors

R-Series Rod Model RS

Temposonics® RS
Stroke length 50...7600 mm



**Position sensor with
IP69K super shield housing**

- Rugged industrial sensor
- Linear and absolute measurement
- Contactless sensing with highest durability
- Analog / SSI / CANbus / DeviceNet / Profibus / EtherCAT
- Sealed IP68 / IP69K

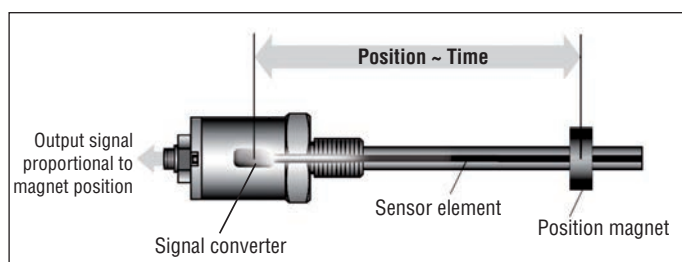

The extremely robust **Temposonics® RS** sensor with super shield housing ensures long-term linear position measurement in the harshest environments. Hermetically sealed with a housing completely made of stainless steel, it meets the requirements of protection modes IP68 and IP69K and is reliably shielded against corrosion and penetration of dirt and water.

Due to non-contact measuring technology, sensor integration into a hermetically sealed housing is possible. A position magnet moves along the outside of the pressure-resistant sensor pipe and marks the position without mechanical contact. For level measurement, an optional float can be used. The modular sensor cartridge design enables the customer to choose the specific sensor output configurations to be installed within the super shield housing to best fit their application requirements. The measuring accuracy and all technical data correspond to the features of the sensor selected inside the housing. A wide choice of interfaces (Analog, Profibus, SSI, CANbus, EtherCAT) is available. Moreover, integration of ATEX-certified and intrinsically safe sensors is possible with the protective housing.

Temposonics® RS sensors are made to fit Temposonics® R-Series with analog and digital outputs. Fixed cable and connector versions can be used on the sensor side. When using standard sensors in this housing, you get a cost efficient solution for use in rugged applications.

Several design combinations are available to fit your application: M18 or ¾"UNF mounting flange thread, various housing length, and single, dual or triple cable glands.

Technical Data (depending on selected interface)

Input	
Stroke length	50...7600 mm
Output	
Interfaces	Analog, SSI, CANbus, Profibus, EtherCAT
Operating conditions	
Dew point, humidity	100% rel. humidity
Ingress protection	IP68 / IP69K
Design, material	
Sensor head	303/304 Stainless steel 316L (1.4404) on request
Sensor stroke	303/304 (1.4305) Stainless steel 316L on request
Pressure rating	350 bar, 700 bar peak
Position magnet	Ring magnet or magnet float
Installation	
Mounting position	Any orientation
Torque moment	< 50 Nm
Rod	Threaded flange M18 x 1.5 or ¾"-16 UNF-3A, Hex nut M18
Electrical connection	
Connection type	Integral cable pigtail termination

Info:

For detailed technical data and electrical connection for the outputs please see data sheets:
R-Series Analog, SSI, CANbus, Profibus, EtherCAT.

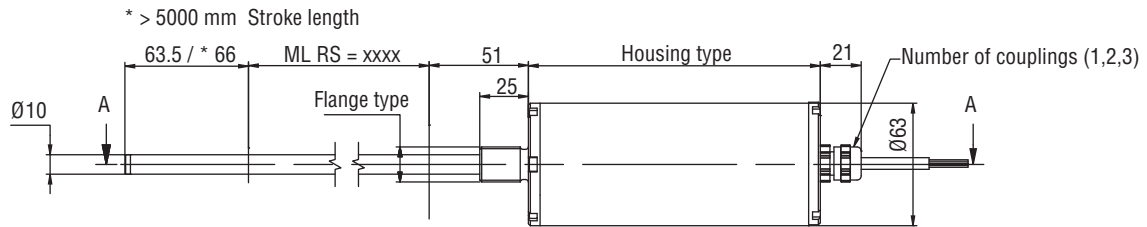

Type 1 Cable outlet
Housing type 1 = 150

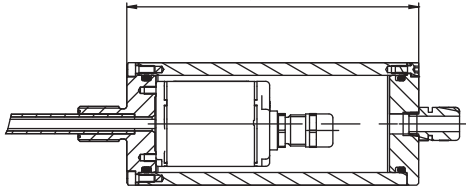

Type 2 Housing short
Housing type 2 = 170

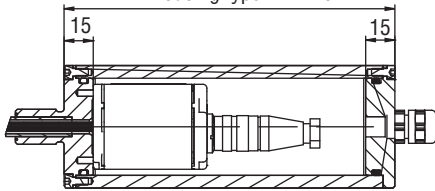

Type 3 Housing long
Housing type 3 = 190

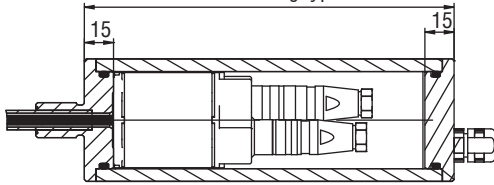

Lids according to the outputs.

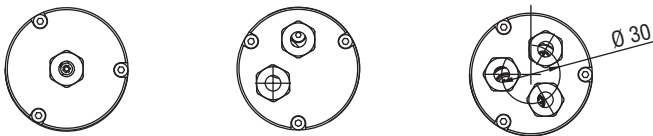

Please use a standard strap wrench to mount the sensor.

Temposonics®

R

S

M

Model

RS - Super shield sensor

Design

M - Flange M18x1.5

S - Flange ¾" - 16 UNF - 3A

Stroke length

0050...7600 mm

Standard: See chart

Further parameter

See data sheets R-Series according to the required output

Analog / SSI / CANbus / Profibus / EtherCAT

Magnets and accessories must be ordered separately.

Accessories

Ring magnet OD33, standard

U-magnet OD33

Ring magnet OD30.5

Position magnet 70x37.5

Block magnet

Part No.

201 542-2

251 416-2

402 316

252 185

403 448

Stroke Length

Stroke Length	Ordering Steps
< 500 mm	5 mm
500...750 mm	10 mm
750...1000 mm	25 mm
1000...2500 mm	50 mm
2500...5000 mm	100 mm
> 5000 mm	250 mm

Temposonics®

Absolute, Non-Contact Position Sensors











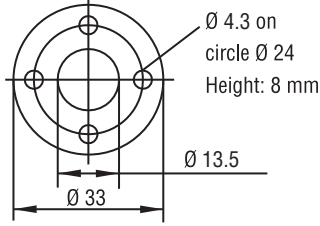

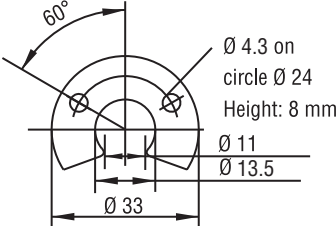
Accessories

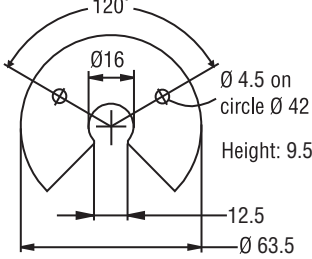

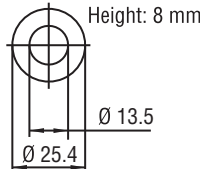
- Position magnets
- Floats
- Connectors
- Clamps
- Cables
- Programming tools
- High pressure housing,...

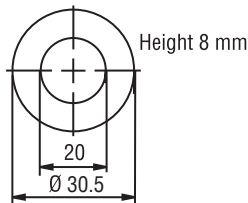
ACCESSORIES R-SERIES

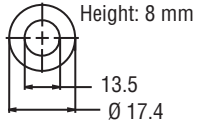

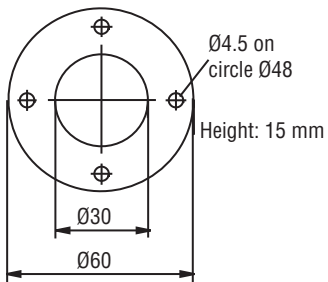







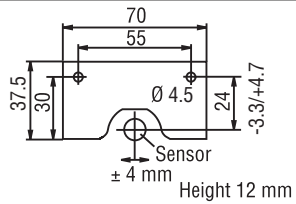

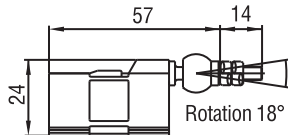

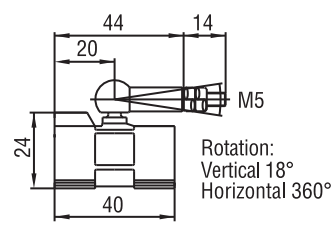
Position magnets, floats, connectors, clamps, cables and programming tools

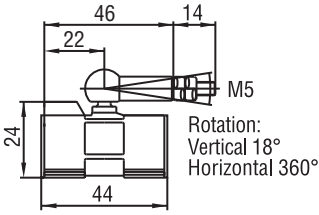
Product	Dimension	Material	Application
 <p>Standard magnet Ring magnet OD33 Part No. 201 542-2</p>	 <p>Ø 4.3 on circle Ø 24 Height: 8 mm Ø 13.5 Ø 33</p>	<p>Composite PA-Ferrite-GF20 Weight ca. 14 g Operating temperature: -40...+100°C Surface pressure max. 40 N/mm² Fastening torque for M4 screws max. 1 Nm</p>	<p>RH, RF, RD4 marked version for sensors with linearity correction option (LCO): Part No. 253 620</p>
 <p>Standard magnet U-magnet OD33 Part No. 251 416-2</p>	 <p>60° Ø 4.3 on circle Ø 24 Height: 8 mm Ø 11 Ø 13.5 Ø 33</p>	<p>Composite PA-Ferrite-GF20 Weight ca. 11 g Operating temperature: -40...+100°C Surface pressure max. 40 N/mm²</p>	<p>RH, RF, RP marked version for sensors with linearity correction option (LCO): Part No. 254 226</p>
 <p>U-magnet OD63,5 Part No. 201 553</p>	 <p>120° Ø 16 Ø 4.5 on circle Ø 42 Height: 9.5 12.5 Ø 63.5</p>	<p>PA 66-GF30 Magnets compound-filled Weight ca. 26 g Operating temperature: -40...+75°C</p>	<p>RH, RF, RP</p>
 <p>Ring magnet OD25,4 Part No. 400 533</p>	 <p>Height: 8 mm Ø 13.5 Ø 25.4</p>	<p>Composite: PA-Ferrite Weight ca. 10 g Operating temperature: -40...+100°C Surface pressure max. 40 N/mm²</p>	<p>RH, RF, RD4 marked version for sensors with linearity correction option (LCO): Part No. 253 621</p>
 <p>Ring magnet OD30,5 Part No. 402 316</p>	 <p>Height 8 mm 20 Ø 30.5</p>	<p>Composite: PA-Ferrite Weight ca. 15 g Operating temperature: -40...+100°C Surface pressure max. 40 N/mm²</p>	<p>RH, RF, RD4</p>
 <p>Ring magnet Part No. 401 032</p>	 <p>Height: 8 mm 13.5 Ø 17.4</p>	<p>PA-Neonbond compound Weight ca. 5 g Operating temperature: -40...+100 Surface pressure max. 20 N/mm²</p>	<p>RH, RD4 (not for multi-position measurement)</p>
 <p>Ring magnet OD60 Part No. MT 0162</p>	 <p>Ø 4.5 on circle Ø 48 Height: 15 mm Ø 30 Ø 60</p>	<p>Al CuMgPb Magnets compound-filled Weight ca. 90 g Operating temperature: -40...+75°C</p>	<p>RH, RF, RD4</p>

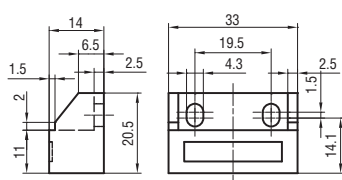
Notice: More magnets available on request. Product pictures may vary from original.

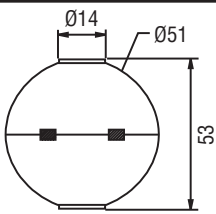
ACCESSORIES R-SERIES

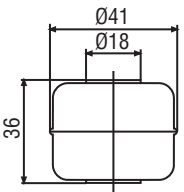

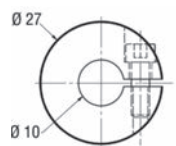







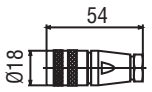

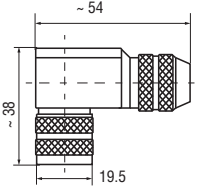
Position magnets, floats, connectors, clamps, cables and programming tools

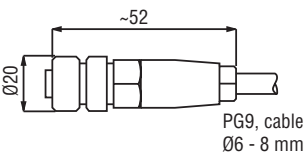
Product	Dimension	Material	Application
 <p>U-magnet 70 Part No. 252 185</p>	 <p>70 55 37.5 30 Ø 4.5 24 -3.3/+4.7 Sensor ± 4 mm Height 12 mm</p>	<p>AlMg4.5Mn, black anodised Magnets compound-filled Weight ca. 75 g Operating temperature: -40...+75°C</p>	<p>RH, RF, RP Resolution min. 10 µm</p>
 <p>Magnet slider V Part No. 252 184</p>	 <p>57 14 24 Rotation 18°</p>	<p>GFK, Magnet hard ferrite Weight ca. 30 g Operating temperature: -40...+75°C</p>	<p>RP</p>
 <p>Magnet slider S Magnet slider G Part No. 252 182 Part No. 253 421</p>	 <p>44 14 20 M5 24 40 Rotation: Vertical 18° Horizontal 360°</p>	<p>GFK, Magnet hard ferrite Weight ca. 30 g Operating temperature: -40...+75°C Magnet slider S: Ball joint CuZn 39Pb3 nickel plated Magnet slider G - free from float: Socket joint, high-strength plastics Ball joint CuZn39Pb3 nickel-plated</p>	<p>RP</p>
 <p>Magnet slider P Part No. 253 673</p>	 <p>46 14 22 M5 24 44 Rotation: Vertical 18° Horizontal 360°</p>	<p>GFK, Magnet hard ferrite Weight ca. 30 g Operating temperature: -40...+75°C with additional end plates</p>	<p>RP</p>
 <p>Block magnet Part No. 403 448</p>	 <p>14 33 6.5 19.5 2.5 4.3 1.5 1.5 2.5 2 20.5 14.1 11</p>	<p>Weight: ca. 20 g Operating temperature: -40...+75°C</p>	<p>RH, RF, RP Resolution min. 10 µm</p>
 <p>Float 50 mm Part No. 251 447</p>	 <p>Ø14 Ø51 53</p>	<p>1.4571 Stainless steel Density: 720 kg/m³ Max. pressure: < 40 bar Weight: 42 ± 3 g</p>	<p>RH, RF</p>
 <p>Float 41 mm Part No. 200 938-2</p>	 <p>Ø41 Ø18 36</p>	<p>1.4404 Stainless steel Density: 740 kg/m³ Max. pressure: = < 8 bar Weight: 20 ± 2 g</p>	<p>RH, RF</p>
 <p>Collar Part No. 560 777</p>	 <p>Ø 27 Ø 10</p>	<p>1.4301 Stainless steel</p>	<p>RH</p>

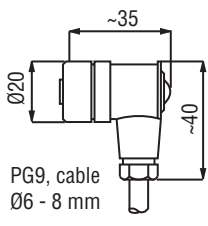
Notice: Product pictures may vary from original.

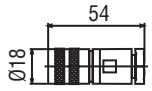
ACCESSORIES R-SERIES

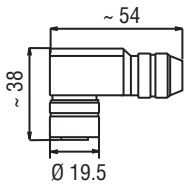

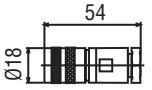







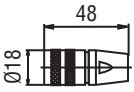

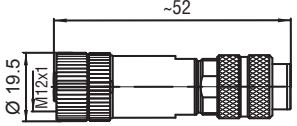
Position magnets, floats, connectors, clamps, cables and programming tools

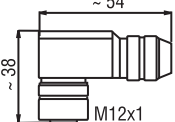
Product	Dimension	Material	Application
 <p>6 pin connector (for cable Ø 6 mm) Part No. 370 623 (female) For cable Ø 6 - 8 mm Part No. 370 423</p>	 <p>54 Ø18</p>	<p>Housing: Zinc nickel-plated Termination: Solder Contact insert: Silver plated Max. Cable-Ø 6 mm or Ø 8 mm depending on design</p>	<p>Analog CAN</p>
 <p>6 pin connector M16, 90° Part No. 370 460 (female)</p>	 <p>~ 54 ~ 38 19.5</p>	<p>Housing: Zinc nickel plated Termination: Solder Contact insert: Silver plated Max. Cable-Ø 8 mm</p>	<p>Analog CAN</p>
 <p>5 pin connector, M12x1 Part No. 370 618 (female)</p>	 <p>~52 Ø20 PG9, cable Ø6 - 8 mm</p>	<p>Housing: PA Termination: Screws clamp Contact insert: (CuZn/Sn) Max. Cable-Ø 6 - 8 mm</p>	<p>CAN Profinet</p>
 <p>5 pin connector, M12x1, 90° Part No. 370 619 (female)</p>	 <p>~35 Ø20 ~40 PG9, cable Ø6 - 8 mm</p>	<p>Housing: PA Termination: Screws clamp Contact insert: (CuZn) Max. Cable-Ø 6 - 8 mm</p>	<p>CAN Profinet</p>
 <p>7 pin connector, M16 Part No. 370 624 (female)</p>	 <p>54 Ø18</p>	<p>Housing: Zinc nickel plated Termination: Solder Contact insert: Silver plated Max. Cable-Ø 8 mm</p>	<p>SSI</p>
 <p>7 pin connector, M16, 90° Part No. 560 779 (female)</p>	 <p>~ 54 ~ 38 Ø 19.5</p>	<p>Housing: Zinc nickel plated Termination: Solder Contact insert: Silver plated Max. Cable-Ø 8 mm</p>	<p>SSI</p>
 <p>6 pin connector, M16 Part No. 370 423 (female) Part No. 370 427 (male)</p>	 <p>54 Ø18</p>	<p>Housing: Zinc nickel plated Termination: Solder Contact insert: Silver plated Max. cable-Ø 8 mm</p>	<p>Profibus (D63)</p>

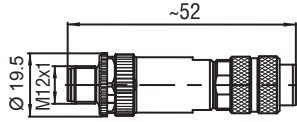
Notice: Product pictures may vary from original.

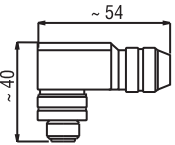
ACCESSORIES R-SERIES

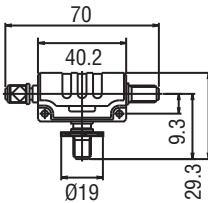

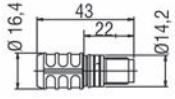







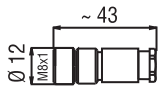

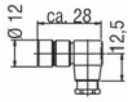
Position magnets, floats, connectors, clamps, cables and programming tools

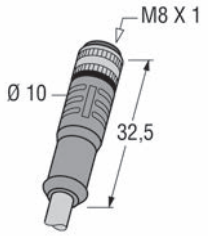
Product	Dimension	Material	Application
 <p>6 pin Bus endplug M16, male Part No. 370 620</p>		Housing: Zinc nickel plated Contact insert: Silver plated	Profibus (D63)
 <p>3 pin connector M12-B Part No. 560 885 (female)</p>		Housing: Zinc nickel plated Termination: IDC (insulation position contact) Contact insert: Silver plated Cable-Ø: 6 - 8 mm	Profibus (D53)
 <p>5 pin 90° connector M12-B Part No. 370 514 (female)</p>		Housing: Zinc nickel plated Termination: spring-type terminal Contact insert: Silver plated Cable-Ø: 6.5 - 8.5 mm	Profibus (D53)
 <p>3 pin connector M12-B Part No. 560 884 (male)</p>		Housing: Zinc nickel plated Termination: IDC (insulation position contact) Contact insert: Silver plated Cable-Ø: 6 - 8 mm	Profibus (D53)
 <p>5 pin 90° connector M12-B Part No. 370 515 (male)</p>		Housing: Zinc nickel plated Termination: Spring-type terminal Contact insert: Silver plated Cable-Ø: 6 - 8 mm	Profibus (D53)
 <p>5 pin Bus T-connector M12 Part No. 560 887</p>		Housing: PA 66 Contact insert: Silver plated	Profibus (D53)
 <p>5 pin Bus endplug M12 Part No. 560 888</p>		Housing: PA 66 Contact insert: Silver plated	Profibus (D53)

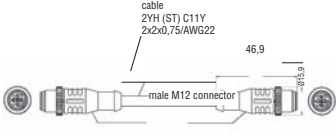
Notice: Product pictures may vary from original.

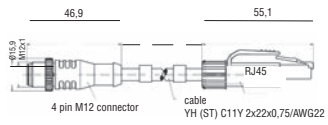
ACCESSORIES R-SERIES

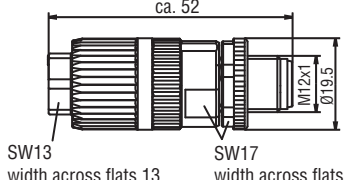









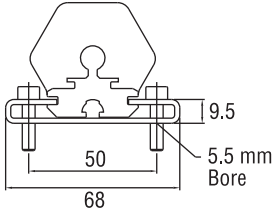

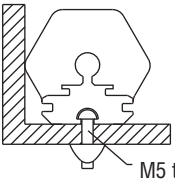

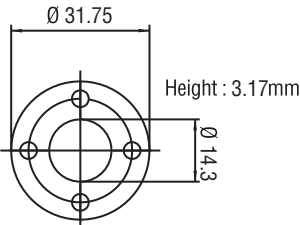
Position magnets, floats, connectors, clamps, cables and programming tools

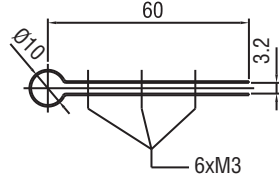
Product	Dimension	Material	Application
 <p>4 pin cable connector M8 Part No. 370 504</p>	 <p>~ 43 Ø 12</p>	<p>Housing: Brass nickel plated Termination: Solder Contact insert: Au Max. cable-Ø 5 mm</p>	<p>Profibus (D53) EtherCAT CAN (D54)</p>
 <p>4 pin cable connector M8, 90° Part No. 560 886</p>	 <p>Ø 12 ca. 28 12,5</p>	<p>Housing: PA 66 Termination: Solder Contact insert: Au Max. cable-Ø 5 mm</p>	<p>Profibus (D53) EtherCAT CAN (D54)</p>
 <p>Cable connector Part No. 530 066 Part No. 530 096 Part No. 530 093</p>	 <p>M8 X 1 Ø 10 32,5</p>	<p>PUR-cable with 4 pin. female connector 5 m length free end 4 x 0.25 mm², shielded for 24 VDC power supply</p> <p>Part No. 530 066 = 5 m length Part No. 530 096 = 10 m length Part No. 530 093 = 15 m length</p>	<p>Profibus (D53) EtherCAT CAN (D54)</p>
 <p>Cable connector Part No. 530 064</p>	 <p>46,9 male M12 connector cable 2YH (ST) C11Y 2x2x0,75/AWG22</p>	<p>5 m industrial ethernet cable (Cat 5e ES) w/2x4 pin M12-connectors (D-coded) PUR-jacket, green</p>	<p>EtherCAT Profinet</p>
 <p>Cable connector Part No. 530 065</p>	 <p>46,9 55,1 4 pin M12 connector RJ45 cable YH (ST) C11Y 2x2x0,75/AWG22</p>	<p>5 m industrial ethernet cable (Cat 5e ES) RJ45 connector and M12-connector (D-coded) PUR-jacket, green</p>	<p>EtherCAT Profinet</p>
 <p>4 pin Bus cable connector Part No. 370 523</p>	 <p>ca. 52 SW13 width across flats 13 SW17 width across flats M12x1 Ø19,5</p>	<p>IDC technology</p>	<p>EtherCAT Profinet</p>
 <p>End cap Part No. 370 537</p>		<p>Brass, nickel plated</p>	<p>EtherCAT</p>

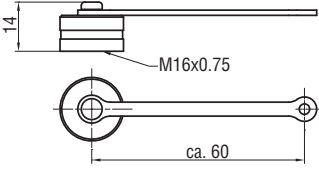
Notice: Product pictures may vary from original.

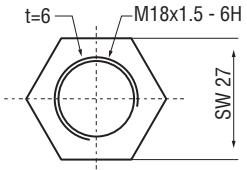
ACCESSORIES R-SERIES

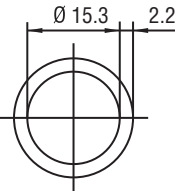





Position magnets, floats, connectors, clamps, cables and programming tools

Product	Dimension	Material	Application
 Mounting clamp Part No. 400 802	 9.5 50 68 5.5 mm Bore	Stainless steel	RP
 T-Nut Part No. 401 602	 M5 thread	Stainless steel	RP
 Spacer Part No. 400 633	 Ø 31.75 Height : 3.17mm Ø 14.3	Aluminum	RH
 Fixing clip Part No. MT 0200	 60 3.2 Ø10 6xM3	Brass Flat section and fastening screws: non-magnetic material	RH
 Metal protection cap for connector M16 Part No. 403 290	 14 M16x0.75 ca. 60	Brass, nickel plated	Analog CAN SSI Profibus
 Hex nut Part No. 500 018	 t=6 M18x1.5 - 6H SW 27	Stainless steel	RH-M
 O-ring Part No. 401 133	 Ø 15.3 2.2	Fluorelastomer FPM 75 Operating temperature: -10...+125°C	RH-M
 Cable Part No. 530 032	3 x 2 x 0,14 mm ² Ø 6 mm	PVC -10...+80 °C	Standard

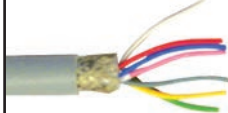
Notice: Product pictures may vary from original.

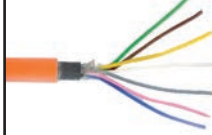
ACCESSORIES R-SERIES





Position magnets, floats, connectors, clamps, cables and programming tools

Product	Dimension	Material	Application
 <p>Cable Part No. 530 052</p>	3 x 2 x 0.25 mm Ø 6.8 mm	Pelon PUR -40...+80°C	Halogen free Oil-resistant High flexible
 <p>Cable Part No. 530 116</p>	4 x 2 x 0.25 mm ²	PUR (-30...+90°C)	Water proof wires
 <p>Cable Part No. 530 112</p>	4 x 2 x 0.25 mm ²	Teflon (-90...+180°C)	Temperature
 <p>Cable Part No. 530 029</p>	7 x 0.14 mm ² EMC protected Ø 7 mm	PUR -20...+70°C	SSI CAN
 <p>Cable Part No. 530 040</p>	BUS + feed-in Ø 8 mm	PVC -30...+80°C	Profibus-DP D63
 <p>Cable Part No. 530 109</p>	BUS conductor, high flexible cable Ø 8 mm	PUR -30...+70°C	Profibus-DP D53
Product	Description		
 <p>Hand-Programmer R-Analog Part No. 253 124</p>	<p>Hand-Programmer R-Analog for 1-magnet sensor is for easy teach-in-setups of measuring length and direction on desired zero/span positions.</p>		

Notice: Product pictures may vary from original.

ACCESSORIES R-SERIES



Position magnets, floats, connectors, clamps, cables and programming tools

Product	Description
 <p>Cabinet-Programmer Part No. 253 408</p>	<p>Cabinet-programmer R-Analog Cabinet-Programmer R-Analog completes the accessories program of MTS absolute position sensors. The unit can be used for adjusting a connected 1-magnet sensor via the leads, using a simple teach-in procedure in the field.</p>
 <p>USB-Programmer R-Analog Part No. 253 134-1</p>	<p>USB-Programmer R-Analog for 1 or 2-magnets sensor (incl. power supply, USB-Cable, sensor-cable and CD-ROM) for setting and reading of position and output values by using a PC for:</p> <ul style="list-style-type: none"> - Zero/Span magnet 1 - Zero/Span magnet 2 - Velocity range - Free assignment of outputs to measured position or velocity - Error output value (e.g. magnet out of stroke)
 <p>USB-Programmer R-SSI Part No. 253 135-1</p>	<p>USB-Programmer R-SSI (incl. Power supply, USB-Cable, Sensor-Cable and CD-ROM) for setting and reading of:</p> <ul style="list-style-type: none"> - Data length - Data format - Resolution - Measuring direction - Synchronous / asynchronous measurement - Offset, begin of the measurement range - Alarm value (magnet outside) - Measurement filter - Differential measurement
 <p>Profibus Address-Programmer kit for D63, D53 or cable connector Part No. 280 640</p>	<p>PROFIBUS Address Programmer is used for setting the slave address to Temposonics® sensors with Profibus-DP Interface. The setup of slave address is normally done by the profibus standard service SetSlaveAddress. Since some master systems do not support this standard, or the customer controller system can not handle it, this MTS service tool can be used for the direct setup of the sensor. The programmer and the sensor will be supplied by the included power supply.</p>

Notice: Product pictures may vary from original.

ACCESSORIES R-SERIES

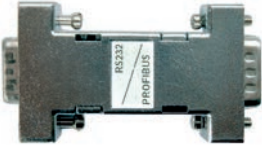
Position magnets, floats, connectors, clamps, cables and programming tools

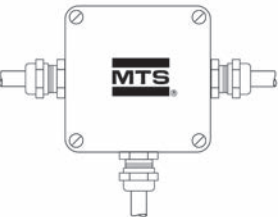
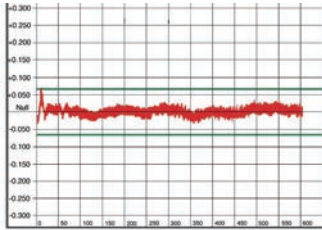
Product	Description
 <p>CANopen Address-Programmer D62 6 pin. female connector M 16 Part No. 252 382-D62 6 pin female 90°-connector M16 Part No. 252 382-D62A</p>	<p>CANopen Address Programmer is used for setting the Node-Address to Temposonics® sensors with CANopen Interface. The setup of Node-Address is normally done by the CAN Bus standard LMT-Service. Since some master systems do not support this standard, or the customer controller system can not handle it, this MTS service tool can be used for the direct setup of the sensor.</p> <p>All you need for using the programmer is a 24 VDC power supply to the sensor. The programming tool will be supplied from the Temposonics® position sensor.</p>
 <p>Profibus Master Simulator Part No. 401 727</p>	<p>PROFIBUS Master Simulator The Master Simulator can be used to check the sensors functions and to change the slave address. The magnet positions can be read out and the diagnostic data as well.</p> <p>Cable D53 Part No. 252 383 Cable D63 Part No. 401 726</p>
 <p>Display and control unit with SSI input Part No. IX 345</p>	<p>Housing: 96 x 48 x 141 mm Cutout: 91 x 44 mm 6-segment LED Display for SSI</p>
 <p>Profibus Filter box Part No. 252 916</p>	<p>Housing: 80 x 75 x 58 mm The box is used for EMC-conformal feeding of 24 VDC supply voltage into the Profibus-DP hybrid cable.</p>
 <p>Linearity diagram Part No. 625 096</p>	<p>DIN A4 printout with sensor data and graphic with the linearity gradient Printout with linearity gradient from the sensor. This gradient can be used to choose a special linear segment also for linearity correction in sections.</p>

Notice: Product pictures may vary from original.

ACCESSORIES R-SERIES

ATEX [ATmosphères EXplosibles]



Approved Sensors: R-Series

- Analog Output
- CANbus [All Versions]
- SSI Output

Note: 1. All products are available as profile and rod version.
2. Cable has to fulfill EN 60079-14.

ATEX Conformity: Marking on MTS Approved Sensor

- ⊕ II 3G Ex nA IIC T4 Gc
- ⊕ II 3D Ex tc IIIB T100°C Dc IP65/67
- 20 °C ≤ Ta ≤ 75 °C
- Pmax = 4 Watt
- Derated 6.5 K/W ≥ 49 °C

Applicable ATEX Regulations / Directives

Directive 2014/34/EU Equipment and protective systems for use in potentially explosive atmospheres.

Related Norms:

- EN 60079-0, EN 60079-15
- EN 60079-31, EN 61326-1,
- EN 61326-2-3

MTS is a certified supplier for position sensors intended to be used in hazardous areas of the Category 3 according to the ATEX standard.
a. In Zone 2 (Gas, Category 3G) in the explosion groups IIA, IIB, IIC.
b. In Zone 22 (Dust, Category 3D) at dusts in the explosion groups IIIA and IIIB

Ordering Code

Temposonics® **R** **M** **1** **- E X**

Model

RP - Profile

- RPM** - U-magnet, OD33
- RPS** - Magnet slider, joint on top
- RPV** - Magnet slider, joint in front

RH - Rod

- RHM** - Flange, M18 x 1.5
- RHS** - Flange ¾" - 16 UNF - 3A
- RS** - Rod, Safety housing
- RSM** - Flange, M18 x 1.5

Stroke length in mm

Profile - 0050...1650 mm

Rod - 0050...1650 mm

Standard: up to 1000 in 50 mm steps, greater 1000 in 250 mm steps

Other length upon request.

Connection type:

R02 - 2 m PVC cable w/o connector, option: R01-R10 (1...10 m)

P02 - 2 m PUR cable w/o connector, option: P01-P10 (1...10 m)

T02 - 2 m Teflon cable w/o connector, option: T01-T10 (1...10 m)

Note: This options are output signal dependent.

For details refer individual catalog section.

Output

Analog / CANbus / SSI

Approved Versions

ATEX

Stroke Length Standard RP RH	
Stroke length	Ordering steps
≤ 500 mm	25 mm
500...1650 mm	50 mm

ACCESSORIES R-SERIES

Precision Position Measurement High Pressure Housing



This High Pressure Housing is **ATEX, IECEx** and **UL and cUL** approved for use in **hazardous areas** with Temposonics® position sensors.

The ATEX, IECEx, UL and cUL approvals cover flammable gases, vapors and dusts.

This housing is made to fit Temposonics® R-Series sensors with analog and digital outputs. Both fixed cable and connector versions can be used. When using a standard sensor in this housing you get a cost efficient solution for use in hazardous locations which also allows easy sensor replacement.

Several design combinations are available to fit your application:

M18 or 3/4" UNF Mounting flange thread - M20 or 1/2" NPT Cable gland thread
- long or short - top-mounted, side-mounted, or dual side-mounted cable glands. See Combination Chart.

All parts are made of stainless steel 316L. The housing is also available in non-approved versions ensuring an outstanding protection to the sensor when used in rugged applications with high humidity and aggressive gases.

ATEX/IECEx



UL/cUL



Material

Cable Gland Threads

Ingress protection code

Approved sensors

Mounting flange

Pressure rating

Peak Pressure

Magnet type

Level measurement

Operating temperature

II 2G Ex db IIC T5 Gb

II 2D Ex tb IIIC T100°C Db
-40°C ≤ T_{amb} ≤ +75°C

ATEX Certificate: ExVeritas 16 ATEX 0192X

IECEx certificate: IECEx EXV 16.0014X

Compliance with

EN IEC 60079-0, EN IEC 60079-1

EN IEC 60079-26, EN IEC 60079-31

Class 1, Division 1, Groups A, B, C, D

UL/cUL-Certificates:

USA: FTRV.E234045

Canada: FTRV7.E234045

In accordance with UL 1203 standard.

Stainless steel AISI 316L (1.4404)

M20×1.5 (only with ATEX and IECEx approved cable glands (Ex db))

1/2" NPT (only with UL and cUL approved cable glands)

IP68 (only with professionally assembled and IP68 approved cable gland)

G-Series Analog + Digital

R-Series Analog

R-Series Profibus

R-Series CANbus

R-Series SSI

Max. power consumption:

U = 24 VDC, I = 150 mA, P = 3.6 W

M18×1.5 or 3/4" - 16UNF - 3A

350 bar

530 bar

Ring magnets

Float on request

-40...+75 °C¹

¹T_{amb}+ is limited to max T_{amb}+ of used sensor -10 °C

Top mounted cable gland

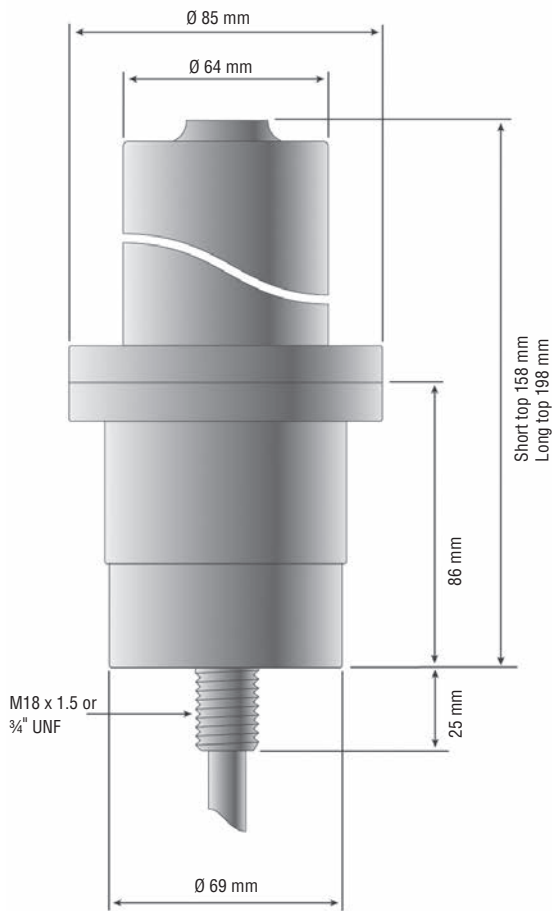

Side mounted cable gland

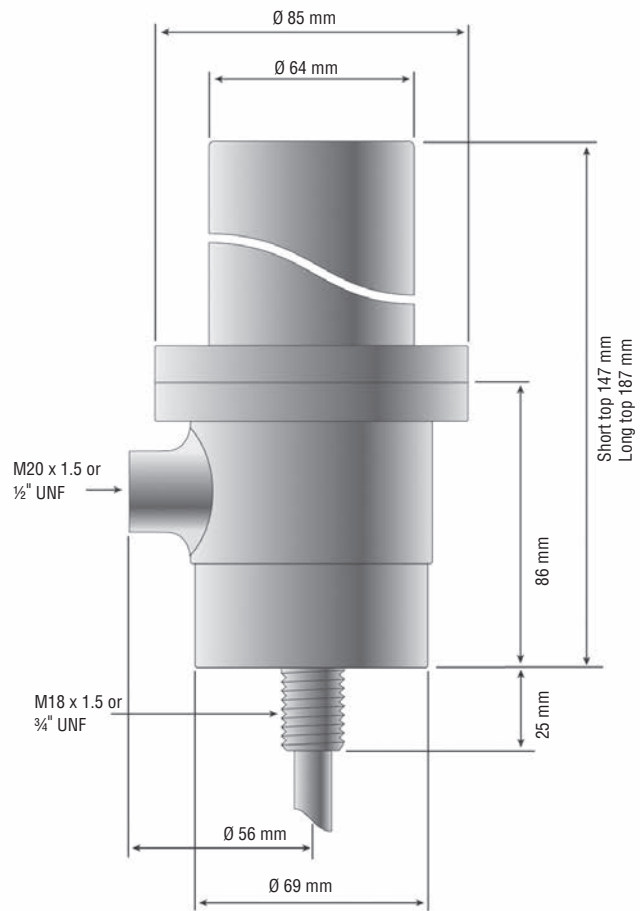

HPH mounting adapter (rotation adapter)





Allows the optimal alignment of the collateral cable gland, when you mount the housing. It's pressure tested up to 580 bar.

The adapter RTA-M18 fits for the standard M18 thread and has a M30x1.5 mounting thread.
 The adapter RTA- $\frac{3}{4}$ " UNF-2 fits for the $\frac{3}{4}$ " UNF threadhousing and has a 1 1/16 - 12 UNF mounting thread.
 The adapter 253961 fits for the $\frac{3}{4}$ " UNF-threadhousing and has a 1 1/4 - 12 mounting thread.

ACCESSORIES R-SERIES

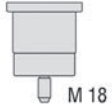
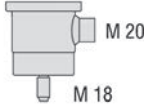
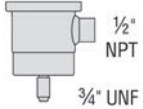
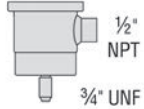
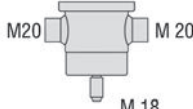
Precision Position Measurement High Pressure Housing

Combination Chart:

Bottom Top	 M 18	 M 20	 1/2" NPT 3/4" UNF	 1/2" NPT 3/4" UNF	 M 20
Approval	ATEX / IECEx	ATEX / IECEx	ATEX / IECEx	UL and cUL	ATEX / IECEx
 M 20	0100				
		0900	1000 ATEX	1000 UL/cUL	1300
 M 20	0300*				
		1700*			2100*

The long top is needed for Profibus sensors

* Selected cable should fulfill the requirements of EN IEC 60079-14

Accessories

Description	Part no.	Type no.	
M20x1.5 cable gland, ATEX/IECEX	4 – 8.5 mm cable diameter, stainless steel	CG-816679	ADE-1F2 no4
M20x1.5 cable gland, ATEX/IECEX	8.5 – 16 mm cable diameter, stainless steel	CG-816609	ADE-1F2 no6
1/2" NPT cable gland ATEX/IECEX/CSA, 180 °C	4.0 – 8.4 mm cable diameter, brass nickeld	403 042	A3LBF / 16 1/2" NPT
Hook key (please order two per piece)		DIN 1018A AMF 80-90 mm	
Ring magnet OD33		201 542-2	
<u>Sensors with Analog-, Start/Stop- or CANbus-output:</u>			
6 pin plug M16		370 423	
6 pin plug M16 with 10 m PUR-cable (Type 530052)		MTS-x-370423-1000-530052 with x = A: Analog, R: Start/Stop, C: CAN	
<u>Sensors with SSI-output:</u>			
7 pin plug M16		370 624	
7 pin plug M16 with 10 m PUR-cable (Type 530052)		MTS-S-370624-1000-530052	
HPH mount adapter (rotation adapter) for M18, M30x1.5		RTA-M18	
HPH mount adapter (rotation adapter) for 3/4" UNF; 1 1/16 - 12 UNF		RTA-3/4" UNF-2	
HPH mount adapter (rotation adapter) for 3/4" UNF; 1 1/4 - 12 UNF		253 961	

Ordering Information:

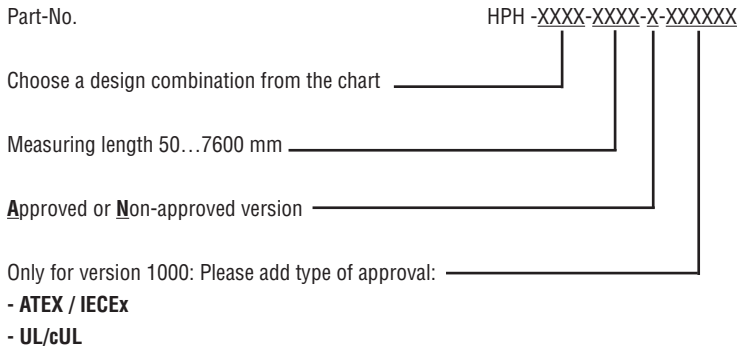

Example: Approved short housing with M18 mounting threads and one side mounted cable gland with M20 threads and a stroke length of 650 mm:
HPH-0900-0650-A

Note!
 Accessories see data sheet "High Pressure Housing"
 Order separately: Sensor R-Series RH-B...
 B = Basic version without hydraulic rod

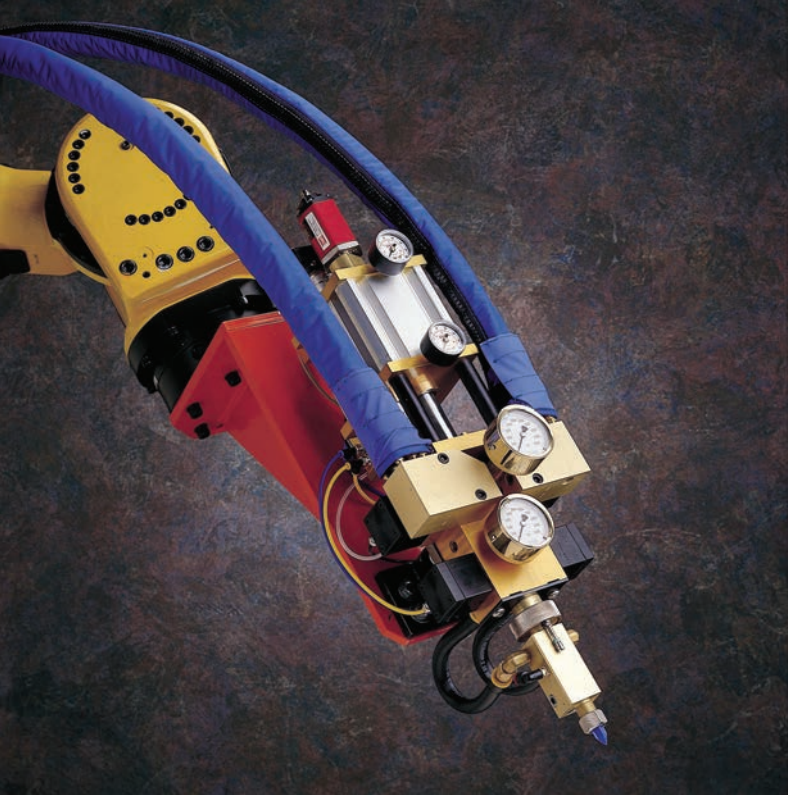

IMAGINE... minimum size of gluing points, exact mixing ratios, filigree finishing. A sensor ensures high-accuracy dosing due to continuous measurement of the flow quantity and speed.

OUR TARGET? YOUR SATISFACTION!

A convincing product always requires a brilliant service. For MTS, the customer's full satisfaction is the uppermost target of our ideas and activities. Excellent technical support is provided by the Application Service Group. Our application engineers expertise, extensive know-how and outstanding knowledge of the branch are available to assist you optimally already during planning. After buying MTS sensors, you can count on the top-class after sales service of the market leader. Whenever necessary, on-site advice by the experienced technicians and engineers is available to you.

Regular courses are held by MTS for optimum training of your operating personnel. At MTS, customer orientation is more than a slogan.

- Always up-to-date with the **MTS E-Newsletter**





UNITED STATES 3001 Sheldon Drive
MTS Systems Corporation Cary, N.C. 27513
Sensors Division Phone: +1 919 677-0100
E-mail: info.us@mtssensors.com

GERMANY Auf dem Schüffel 9
MTS Sensor Technologie 58513 Lüdenscheid
GmbH & Co. KG Phone: +49 2351 9587-0
E-mail: info.de@mtssensors.com

ITALY Phone: +39 030 988 3819
Branch Office E-mail: info.it@mtssensors.com

FRANCE Phone: +33 1 58 4390-28
Branch Office E-mail: info.fr@mtssensors.com

UK Phone: +44 79 44 15 03 00
Branch Office E-mail: info.uk@mtssensors.com

CHINA Phone: +86 21 2415 1000 / 2415 1001
Branch Office E-mail: info.cn@mtssensors.com

JAPAN Phone: +81 3 6416 1063
Branch Office E-mail: info.jp@mtssensors.com

Document Part Number:
551303 Revision J (EN) 10/2019

www.mtssensors.com

MTS, Temposonics and Level Plus are registered trademarks of MTS Systems Corporation in the United States; MTS SENSORS and the MTS SENSORS logo are trademarks of MTS Systems Corporation within the United States. These trademarks may be protected in other countries. All other trademarks are the property of their respective owners. Copyright © 2019 MTS Systems Corporation. No license of any intellectual property rights is granted. MTS reserves the right to change the information within this document, change product designs, or withdraw products from availability for purchase without notice. Typographic and graphics errors or omissions are unintentional and subject to correction. Visit www.mtssensors.com for the latest product information.