

Data Sheet

EP / EL CANopen

Magnetostrictive Linear Position Sensors

- For standard applications
- Position measurement with more than one magnet
- Ideal for limited installation space

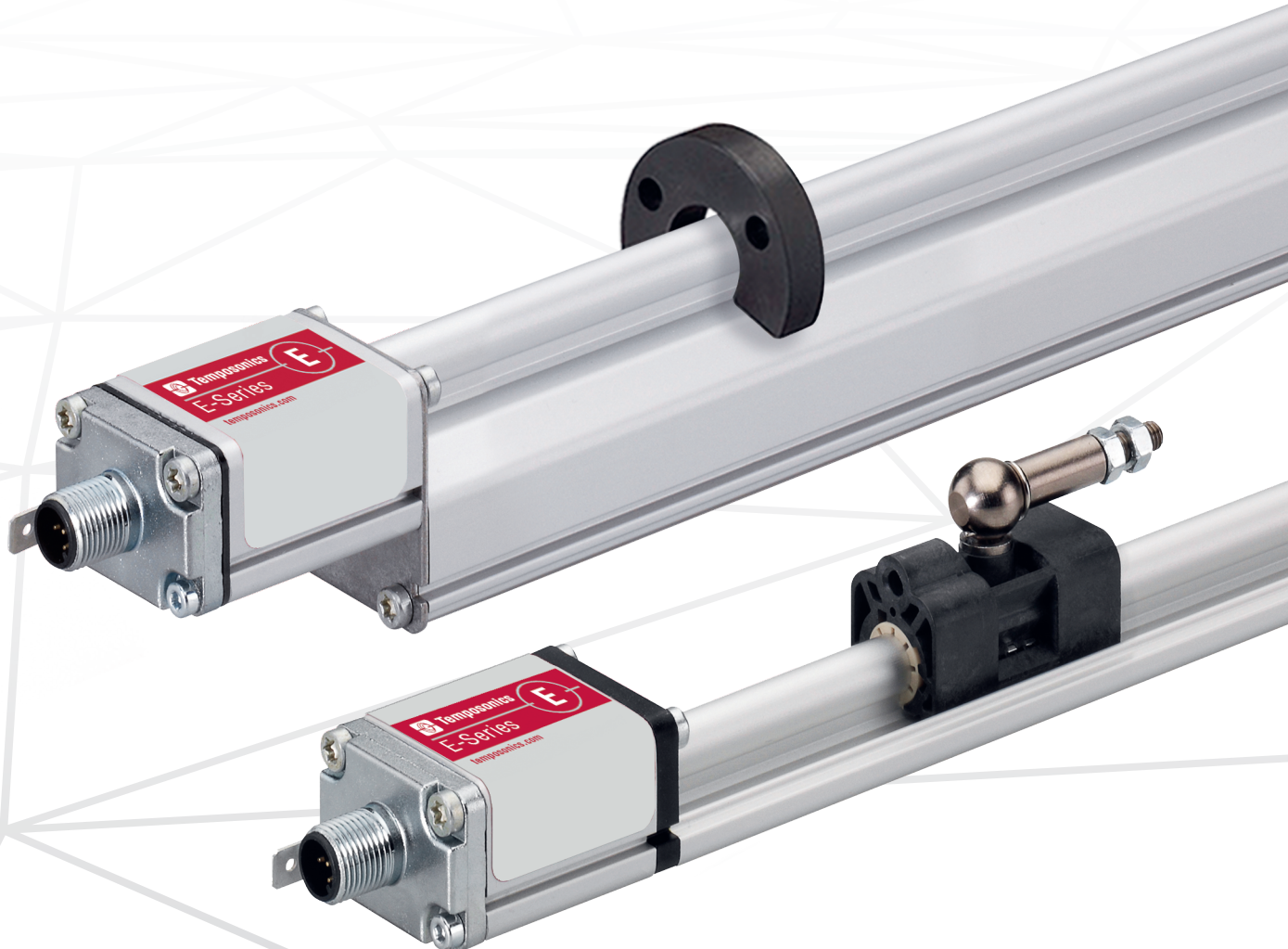

MEASURING TECHNOLOGY

The absolute, linear position sensors provided by Temposonics rely on the company's proprietary magnetostrictive technology, which can determine position with a high level of precision and robustness. Each Temposonics position sensor consists of a ferromagnetic waveguide, a position magnet, a strain pulse converter and supporting electronics. The magnet, connected to the object in motion in the application, generates a magnetic field at its location on the waveguide. A short current pulse is applied to the waveguide. This creates a momentary radial magnetic field and torsional strain on the waveguide. The momentary interaction of the magnetic fields releases a torsional strain pulse that propagates the length of the waveguide. When the ultrasonic wave reaches the end of the waveguide it is converted into an electrical signal. Since the speed of the ultrasonic wave in the waveguide is precisely known, the time required to receive the return signal can be converted into a linear position measurement with both high accuracy and repeatability.

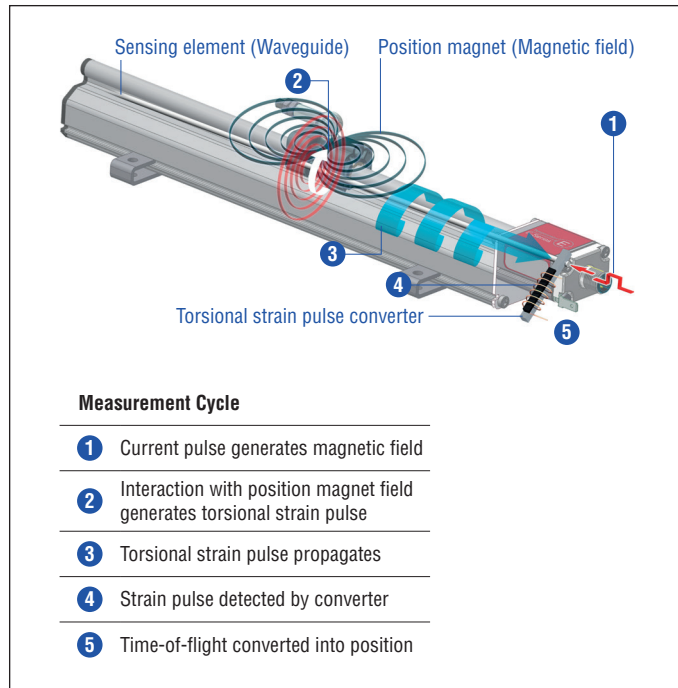

Fig. 1: Time-of-flight based magnetostrictive position sensing principle

EP / EL SENSOR

Robust, non-contact and wear free, the Temposonics linear position sensors provide the best durability and precise position measurement feedback in harsh industrial environments. Measurement accuracy is tightly controlled by the quality of the waveguide manufactured exclusively by Temposonics.

The compact Temposonics® EP as well as the ultra low Temposonics® EL are profile sensors suitable for standard applications and in particular for applications with limited installation space. The evaluation electronics is accommodated in an aluminum sensor housing. Typical fields of applications are plastics industry, metal forming and wood-working as well as factory automation.

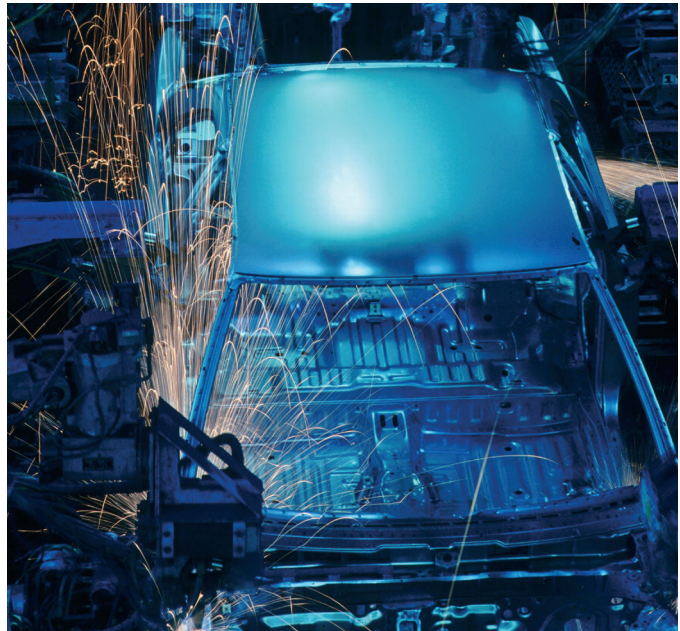

Fig. 2: Typical application: Factory automation

TECHNICAL DATA

Output	
Interface	CAN System ISO-11898
Data protocol	CANopen: CIA standard DS 301 V3.0 / encoder profile DS 406 V3.1
Baud rate, kBit/s	1000 800 500 250 125
Cable length, m	< 25 < 50 < 100 < 250 < 500
	The sensor will be supplied with ordered baud rate, changeable by customer via LSS
Measured value	Position / option: multi-position measurement (2 positions)
Measurement parameters	
Resolution	10 µm, 20 µm
Cycle time	1 ms
Linearity ¹	Magnet slider: ≤ ±0.02 % F.S. (minimum ±60 µm), U-magnet: ≤ ±0.02 % F.S. (minimum ±60 µm), block magnet: ≤ ±0.03 % (minimum ±90 µm)
Repeatability	≤ ±0.005 % F.S. (minimum ±20 µm)
Operating conditions	
Operating temperature	-40...+75 °C (-40...+167 °F)
Humidity	90 % rel. humidity, no condensation
Ingress protection ^{2,3}	IP67 (if mating connectors are correctly fitted)
Shock test	100 g (single shock) IEC standard 60068-2-27
Vibration test	15 g / 10...2000 Hz IEC standard 60068-2-6 (resonance frequencies excluded)
EMC test	Electromagnetic emission according to EN 61000-6-3 Electromagnetic immunity according to EN 61000-6-2 The sensor meets the requirements of the EC directives and is marked with CE .
Magnet movement velocity	Magnet slider: ≤ 5 m/s; U-magnet: Any; block magnet: Any
Design / Material	
Sensor electronics housing	Aluminum
Sensor profile	Aluminum
Stroke length	50...2540 mm (2...100 in.)
Mechanical mounting	
Mounting position	Any
Mounting instruction	Please consult the technical drawings and the operation manual (document number: 551774)
Electrical connection	
Connection type	M12 (5 pin) male connector
Operating voltage	+24 VDC (-15 / +20 %); UL recognition requires an approved power supply with energy limitation (UL 61010-1), or Class 2 rating according to the National Electrical Code (USA) / Canadian Electrical Code.
Ripple	≤ 0.28 V _{pp}
Current consumption	40...60 mA (depending on stroke length)
Dielectric strength	500 VDC (DC ground to machine ground)
Polarity protection	Up to -30 VDC
Overvoltage protection	Up to 36 VDC

1/ Magnet slider # 252 182 and # 252 184, U-magnet # 251 416-2 and block magnet # 403 448

2/ The IP rating is not part of the UL recognition

3/ The IP rating IP67 is only valid for the sensor electronics housing, as water and dust can get inside the profile

TECHNICAL DRAWING

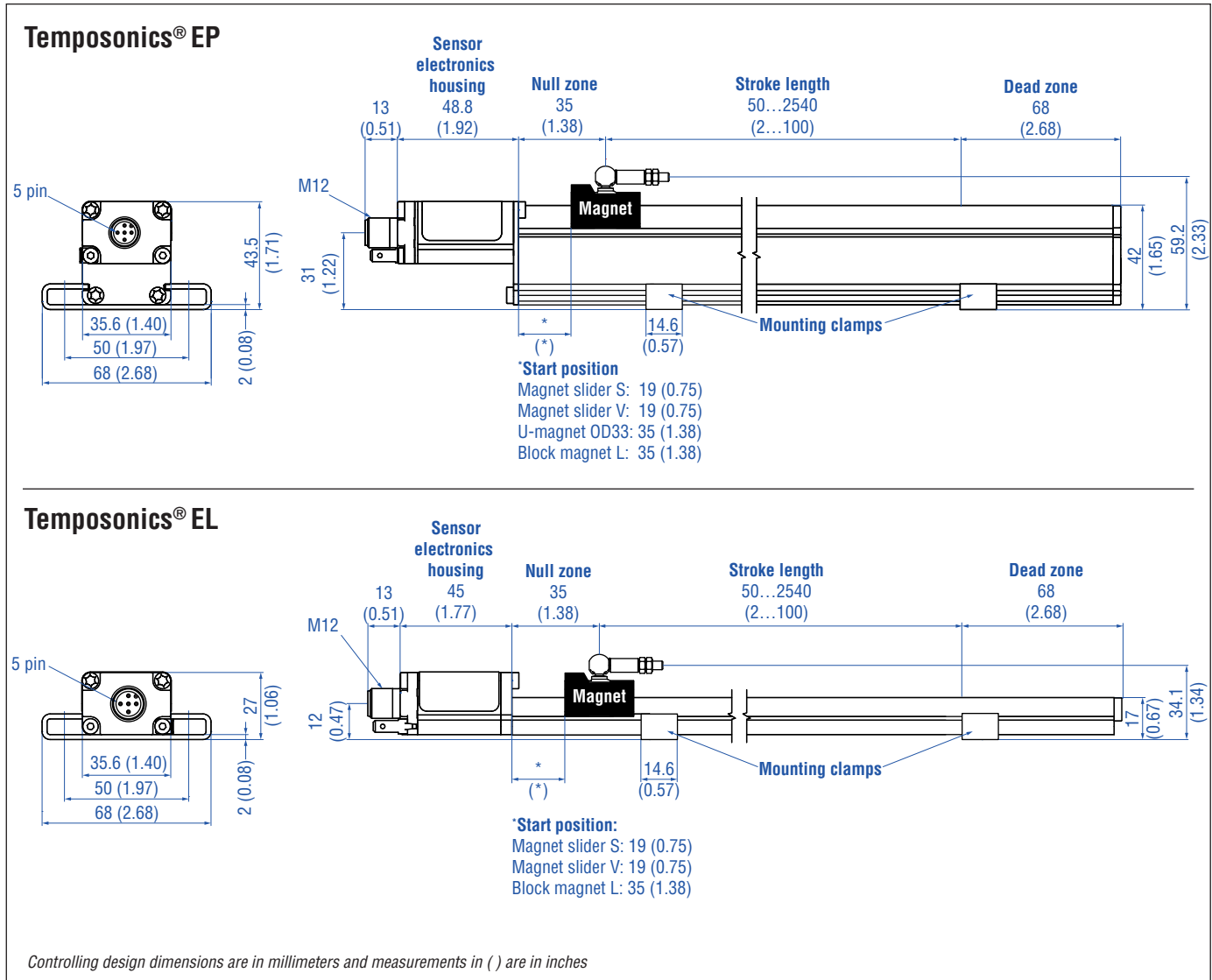

CONNECTOR WIRING

D34

M12 A-coded	Pin	Function
	1	Shield
	2	+24 VDC (-15 / +20 %)
	3	DC Ground (0 V)
	4	CAN_H
	5	CAN_L

FREQUENTLY ORDERED ACCESSORIES – Additional options available in our [Accessories Guide](#)  [551444](#)

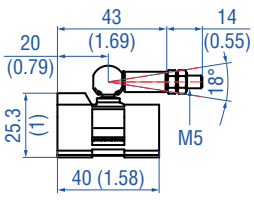
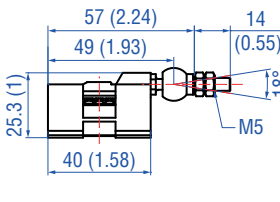
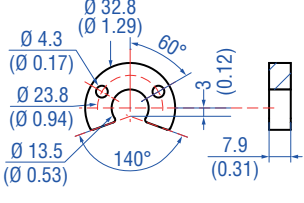
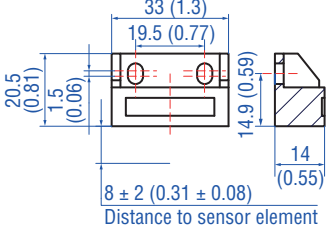
Position magnets			
			
<p>Magnet slider S Part no. 252 182</p>	<p>Magnet slider V Part no. 252 184</p>	<p>U-magnet OD33 Part no. 251 416-2</p>	<p>Block magnet L Part no. 403 448</p>
<p>Material: GFK, magnet hard ferrite Weight: Ca. 35 g Operating temperature: -40...+75 °C (-40...+167 °F)</p>	<p>Material: GFK, magnet hard ferrite Weight: Ca. 35 g Operating temperature: -40...+75 °C (-40...+167 °F)</p>	<p>Only for: EP Material: PA ferrite GF20 Weight: Ca. 11 g Operating temperature: -40...+105 °C (-40...+221 °F) Surface pressure: Max. 40 N/mm² Fastening torque for M4 screws: 1 Nm</p>	<p>Material: Hard ferrite Weight: Ca. 20 g Operating temperature: -40...+75 °C (-40...+167 °F) Fastening torque for M4 screws: 1 Nm</p>

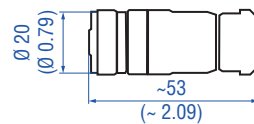
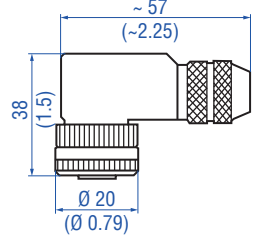
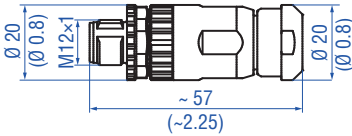
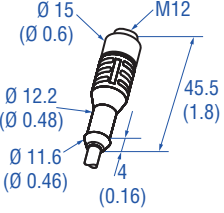
Cable connectors ⁴		Cord sets	
			
<p>M12 (5 pin) female, straight Part no. 370 677</p>	<p>M12 (5 pin) female, angled Part no. 370 678</p>	<p>M12 (5 pin) male, straight Part no. 561 665</p>	<p>M12 (5 pin) female, straight Part no. 370 673</p>
<p>Housing: GD-Zn, Ni / IP67 Termination: Screw; max. 1.5 mm² Contact insert: CuZn Operating temperature: -30...+85 °C (-22...+185 °F) Cable Ø: 4...8 mm (0.16...0.31 in.) Fastening torque: 0.6 Nm</p>	<p>Housing: GD-Zn, Ni / IP67 Termination: Screw; max. 0.75 mm² Contact insert: CuZn Operating temperature: -25...+85 °C (-13...+185 °F) Cable Ø: 5...8 mm (0.2...0.31 in.) Fastening torque: 1 Nm</p>	<p>Housing: GD-Zn, Ni / IP67 Termination: Screw; max. 1.5 mm² Contact insert: CuZn Cable Ø: 4...8 mm (0.16...0.31 in.) Fastening torque: 0.6 Nm</p>	<p>Ingress protection: IP67 Cable: Shielded, pigtail end Cable length: 5 m (16.4 ft.)</p>

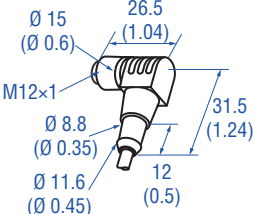
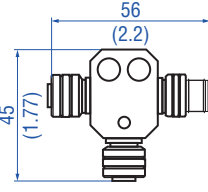
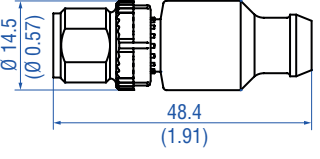
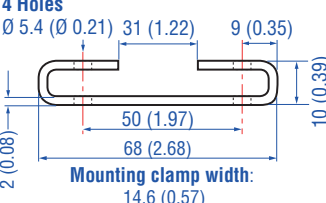
Cord sets	Connection accessories	Mounting clamp	
			
<p>M12 (5 pin) female, angled Part no. 370 675</p>	<p>M12 (5 pin) CANopen T-Connector Part no. 370 691</p>	<p>M12 (5 pin) CANopen bus terminator Part no. 370 700</p>	<p>Mounting clamp Part no. 403 508</p>
<p>Ingress protection: IP67 Cable: Shielded, pigtail end Cable length: 5 m (16.4 ft.)</p>	<p>Selfcuring coupling nut 2 × cable connector female 1 × cable connector male shielded</p>	<p>Housing: PUR Contact insert: Au</p>	<p>Material: Stainless steel 1.4301 / 1.4305 (AISI 304 / 303)</p>

⁴ Follow the manufacturer's mounting instructions
Controlling design dimensions are in millimeters and measurements in () are in inches

ORDER CODE

1	2	3	4	5	6	7	8	9	10	11	12	13	14	15	16	17	18	19	20	21	22
E		0						D	3	4	1	C						1			
a		b	c					d			e	f				g	h	i	j optional		

a	Sensor model
L	Ultra low profile
P	Compact profile

b	Design
0	Without position magnet

c	Stroke length				
X	X	X	X	M	0050...2540 mm
X	X	X	X	U	002.0...100.0 in.

Standard stroke length (mm)*

Stroke length	Ordering steps
50 ... 500 mm	25 mm
500...2540 mm	50 mm

Standard stroke length (in.)*

Stroke length	Ordering steps
2 ... 20 in.	1.0 in.
20...100 in.	2.0 in.

d	Connection type		
D	3	4	M12 (5 pin) male connector

e	Operating voltage
1	+24 VDC (-15 / +20 %)

f	Output			
C	3	0	4	CANopen
C	4	0	4	CANopen (bus terminator)

g	Baud rate
1	1000 kBit/s
2	500 kBit/s
3	250 kBit/s
4	125 kBit/s

h	Resolution
4	10 µm
5	20 µm

i	Type
1	Standard

Optional

j	Magnet number for multi-position measurement		
Z	0	2	2 magnets

DELIVERY



- Sensor
- 2 mounting clamps up to 1250 mm (50 in.) stroke length
- + 1 mounting clamp for each 500 mm (20 in.) additional stroke length

Accessories have to be ordered separately.

NOTICE

Use magnets of the same type for multi-position measurement, e.g. 2 × U-magnets (part no. 251 416-2).

Manuals & Software available at:
www.temposonics.com

* / Non standard stroke lengths are available; must be encoded in 5 mm / 0.1 in. increments

UNITED STATES
Temposonics, LLC
Americas & APAC Region
3001 Sheldon Drive
Cary, N.C. 27513
Phone: +1 919 677-0100
E-mail: info.us@temposonics.com

GERMANY
Temposonics
GmbH & Co. KG
EMEA Region & India
Auf dem Schüffel 9
58513 Lüdenscheid
Phone: +49 2351 9587-0
E-mail: info.de@temposonics.com

ITALY
Branch Office
Phone: +39 030 988 3819
E-mail: info.it@temposonics.com

FRANCE
Branch Office
Phone: +33 6 14 060 728
E-mail: info.fr@temposonics.com

UK
Branch Office
Phone: +44 79 21 83 05 86
E-mail: info.uk@temposonics.com

SCANDINAVIA
Branch Office
Phone: +46 70 29 91 281
E-mail: info.sca@temposonics.com

CHINA
Branch Office
Phone: +86 21 2415 1000 / 2415 1001
E-mail: info.cn@temposonics.com

JAPAN
Branch Office
Phone: +81 3 6416 1063
E-mail: info.jp@temposonics.com

Document Part Number:
551307 Revision D (EN) 03/2018



temposonics.com