

# Temposonics®

Magnetostrictive Linear Position Sensors

## Temposonics® R-Series V PROFINET RT & IRT Operation Manual



**V**  
THE NEW GENERATION

## Table of contents

<b>1. Introduction</b> .....	<b>3</b>
1.1 Purpose and use of this manual .....	3
1.2 Used symbols and warnings .....	3
<b>2. Safety instructions</b> .....	<b>3</b>
2.1 Intended use .....	3
2.2 Foreseeable misuse .....	3
2.3 Installation, commissioning and operation .....	4
2.4 Safety instructions for use in explosion-hazardous areas .....	4
2.5 Warranty .....	4
2.6 Return .....	4
<b>3. Identification</b> .....	<b>5</b>
3.1 Order code of Temposonics® RP5 .....	5
3.2 Order code of Temposonics® RH5 .....	6
3.3 Nameplate .....	7
3.4 Approvals .....	7
3.5 Scope of delivery .....	7
<b>4. Product description and commissioning</b> .....	<b>8</b>
4.1 Functionality and system design .....	8
4.2 Styles and installation of Temposonics® RP5 .....	9
4.3 Styles and installation of Temposonics® RH5 .....	10
4.4 Magnet installation .....	13
4.5 Alignment of the magnet with the option "Internal linearization" .....	15
4.6 Replacement of sensor .....	16
4.7 Electrical connections .....	18
4.8 Frequently ordered accessories for RP5 design .....	19
4.9 Frequently ordered accessories for RH5 design .....	20
4.10 Frequently ordered accessories for PROFINET output .....	21
<b>5. Operation</b> .....	<b>22</b>
5.1 Initial start-up .....	22
5.2 LED Status .....	22
5.3 Supported network functions .....	23
<b>6. Programming and configuration in the TIA Portal</b> .....	<b>23</b>
6.1 General Information .....	23
6.2 Parameter description for MTS profile .....	23
6.3 Parameter description for encoder profile .....	26
<b>7. Programming and Configuration via SIMOTION SCOUT</b> .....	<b>31</b>
7.1 Creating and configuring a project .....	31
7.2 Integrating the GSDML file .....	33
7.3 Integration and configuration of the sensor with MTS profile .....	33
7.4 Configuration of the sensor in the network .....	36
7.5 Enable RT mode and IRT mode .....	38
7.6 Downloading the program to the controller .....	40
7.7 Creating a program for recording the raw Position Values .....	41
7.8 Creating a program for evaluating the raw position data .....	42
7.9 Display of failure information .....	44
<b>8. TempoLink smart assistant with R-Series V PROFINET</b> .....	<b>45</b>
<b>9. Maintenance and troubleshooting</b> .....	<b>45</b>
9.1 Error conditions, troubleshooting .....	45
9.2 Maintenance .....	45
9.3 Repair .....	45
9.4 List of spare parts .....	45
9.5 Transport and storage .....	45
<b>10. Removal from service/dismantling</b> .....	<b>45</b>
<b>11. Technical data</b> .....	<b>46</b>
11.1 Technical data Temposonics® R-Series V RP5 .....	46
11.2 Technical data Temposonics® R-Series V RH5 .....	47
<b>12. Appendix I</b> .....	<b>48</b>
<b>13. Appendix II</b> .....	<b>49</b>
<b>14. Glossary</b> .....	<b>50</b>

## 1. Introduction

### 1.1 Purpose and use of this manual

Before starting the operation of Temposonics® position sensors, read this documentation thoroughly and follow the safety information. Keep this manual for future reference!

The content of this technical documentation and of its appendix is intended to provide information on mounting, installation and commissioning by qualified automation personnel <sup>1</sup> or instructed service technicians who are familiar with the project planning and dealing with Temposonics® sensors.

### 1.2 Used symbols and warnings

Warnings are intended for your personal safety and for avoidance of damage to the described product or connected devices. In this documentation, safety information and warnings to avoid danger that might affect the life and health of operating or service personnel or cause material damage are highlighted by the pictogram defined below.

Symbol	Meaning
<b>NOTICE</b>	This symbol is used to point to situations that may lead to material damage, but not to personal injury.

## 2. Safety instructions

### 2.1 Intended use

This product may be used only for the applications defined under item 1 and only in conjunction with the third-party devices and components recommended or approved by MTS Sensors. As a prerequisite of proper and safe operation the product requires correct transport, storage, mounting and commissioning and must be operated with utmost care.

- The sensor systems of all Temposonics® series are intended exclusively for measurement tasks encountered in industrial, commercial and laboratory applications. The sensors are considered as system accessories and must be connected to suitable evaluation electronics, e.g. a PLC, IPC, indicator or other electronic control unit.

<sup>1/</sup> The term "qualified technical personnel" characterizes persons who

- are familiar with the safety concepts of automation technology applicable to the particular project and
- are competent in the field of electromagnetic compatibility (EMC) or
- have received adequate training for commissioning and service operations or
- and are familiar with the operation of the device and know the information required for correct operation provided in the product documentation

### 2.2 Foreseeable misuse

Foreseeable misuse	Consequence
Wrong sensor connection	The sensor will not work properly or can be damaged
Operate the sensor out of the operating temperature range	No signal output – the sensor can be damaged
Power supply is out of the defined range	Signal output is wrong / no signal output / the sensor will be damaged
Position measurement is influenced by an external magnetic field	Signal output is wrong
Cables are damaged	Short circuit – the sensor can be destroyed / sensor does not respond
Spacers are missing / installed in a wrong order	Error in position measurement
Wrong connection of ground / shield	Signal output is disturbed – the electronics can be damaged
Use of a magnet that is not specified by MTS Sensors	Error in position measurement

Do not alter the sensor afterwards.  
→ The sensor might be damaged.

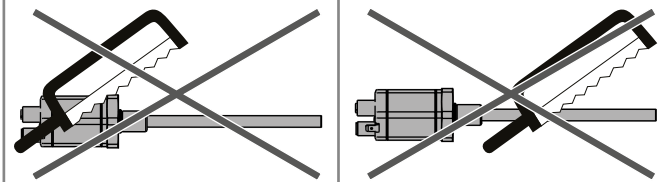

Do not step on the sensor.  
→ The sensor might be damaged.

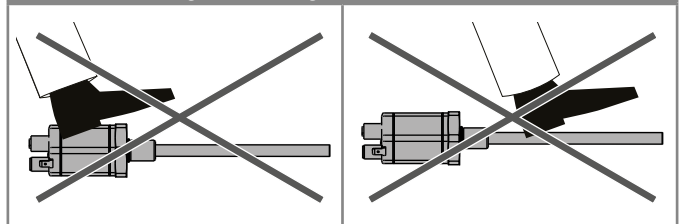

## 2.3 Installation, commissioning and operation

The position sensors must be used only in technically safe conditions. To maintain this condition and to ensure safe operation, installation, connection and service, work may be performed only by qualified technical personnel.

If danger of injury to persons or of damage to operating equipment is caused by sensor failure or malfunction, additional safety measures such as plausibility checks, limit switches, EMERGENCY STOP systems, protective devices etc. are required. In the event of trouble, shut down the sensor and protect it against accidental operation.

### Safety instructions for commissioning

To maintain the sensor's operability, it is mandatory to follow the instructions given below.

1. Protect the sensor against mechanical damage during installation and operation.
2. Do not open or dismantle the sensor.
3. Connect the sensor very carefully and pay attention to the polarity of connections and power supply.
4. Use only approved power supplies.
5. Ensure the sensor is operating within the defined limits for supply voltage, environmental conditions, etc.
6. Check the function of the sensor regularly and provide documentation of the checks.
7. Before applying power, ensure that nobody's safety is jeopardized by starting machines.

## 2.4 Safety instructions for use in explosion-hazardous areas

The sensor is not suitable for operation in explosion-hazardous areas.

## 2.5 Warranty

MTS Sensors grants a warranty period for the Temposonics® position sensors and supplied accessories relating to material defects and faults that occur despite correct use in accordance with the intended application<sup>2</sup>. The MTS Sensors obligation is limited to repair or replacement of any defective part of the unit. No warranty can be provided for defects that are due to improper use or above average stress of the product, as well as for wear parts. Under no circumstances will MTS Sensors accept liability in the event of offense against the warranty rules, no matter if these have been assured or expected, even in case of fault or negligence of the company. MTS Sensors explicitly excludes any further warranties. Neither the company's representatives, agents, dealers nor employees are authorized to increase or change the scope of warranty.

## 2.6 Return

For diagnostic purposes, the sensor can be returned to MTS Sensors or a repair facility explicitly authorized by MTS Sensors. Any shipment cost is the responsibility of the sender<sup>2</sup>. For a corresponding form, see chapter "12. Appendix I" on page 48.

### NOTICE

When returning sensors, place protective caps on male and female connectors of the sensor. For pigtail cables, place the cable ends in a static shielding bag for electrostatic discharge (ESD) protection. Fill the outer packaging around the sensor completely to prevent damage during transport.

<sup>2/</sup> See also applicable MTS Sensors terms of sales and delivery on:  
[www.mtssensors.com](http://www.mtssensors.com)



### 3. Identification

#### 3.1 Order code of Temposonics® RP5

1	2	3	4	5	6	7	8	9	10	11	12	13	14	15	16	17	18	19	20
R	P	5										D	5	8	1	U	4		
a			b	c	d						e	f			g	h			

<b>a</b>	<b>Sensor model</b>		
R	P	5	Profile

<b>b</b>	<b>Design</b>
G	Magnet slider backlash free (part no. 253 421), suitable for internal linearization
L	Block magnet L (part no. 403 448)
M	U-magnet OD33 (part no. 251 416-2), suitable for internal linearization
N	Magnet slider longer ball-jointed arm (part no. 252 183), suitable for internal linearization
O	No position magnet
S	Magnet slider joint at top (part no. 252 182), suitable for internal linearization
V	Magnet slider joint at front (part no. 252 184), suitable for internal linearization

<b>c</b>	<b>Mechanical options</b>
A	Standard
V	Fluorelastomer seals for the sensor electronics housing

<b>d</b>	<b>Stroke length</b>				
X	X	X	X	M	0025...6350 mm
<b>Standard stroke length (mm)</b>		<b>Ordering steps</b>			
25... 500 mm		25 mm			
500...2500 mm		50 mm			
2500...5000 mm		100 mm			
5000...6350 mm		250 mm			
X	X	X	X	U	001.0...250.0 in.
<b>Standard stroke length (in.)</b>		<b>Ordering steps</b>			
1... 20 in.		1.0 in.			
20...100 in.		2.0 in.			
100...200 in.		4.0 in.			
200...250 in.		10.0 in.			
Non-standard stroke lengths are available; must be encoded in 5 mm/0.1 in. increments.					

<b>e</b>	<b>Number of magnets</b>	
X	X	01...30 position(s) (1...30 magnet(s))

<b>f</b>	<b>Connection type</b>		
D	5	8	2 × M12 female connectors (5 pin), 1 × M12 male connector (4 pin)

<b>g</b>	<b>System</b>
1	Standard

<b>h</b>	<b>Output</b>			
U	4	0	1	PROFINET RT & IRT, position and velocity, encoder profile (1 position)
U	4	0	2	PROFINET RT & IRT, position and velocity, MTS profile (1...30 position(s))
U	4	1	1	PROFINET RT & IRT, position and velocity, encoder profile, internal linearization (1 position)
U	4	1	2	PROFINET RT & IRT, position and velocity, MTS profile, internal linearization (1...30 position(s))

#### NOTICE

- Select the MTS profile (U402 or U412) in **h** "Output" for multi-position measurement.
- For the RP5, the magnet selected in **b** "Design" is included in the scope of delivery. Specify the number of magnets for your application. For multi-position measurements with more than 1 magnet, order the other magnets separately.
- The number of magnets is limited by the stroke length. The minimum allowed distance between magnets (i.e. front face of one to the front face of the next one) is 75 mm (3 in.).
- Use magnets of the same type for multi-position measurement, e.g. 2 × U-magnet (part no. 251 416-2).
- If the option for internal linearization (U411, U412) in **h** "Output" is chosen, select a suitable magnet.

### 3.2 Order code of Temposonics® RH5

1	2	3	4	5	6	7	8	9	10	11	12	13	14	15	16	17	18	19	20
R	H	5										D	5	8	1	U	4		
a			b	c	d						e	f			g	h			

a	Sensor model
R H 5	Rod

b	Design
B	Base unit (only for replacement)
J	Threaded flange M22×1.5-6g (rod Ø 12.7 mm), stroke length: 25...5900 mm (1...232 in.)
M	Threaded flange M18×1.5-6g (standard)
S	Threaded flange ¾"-16 UNF-3A (standard)
T	Threaded flange ¾"-16 UNF-3A (with raised-face)

c	Mechanical options
A	Standard
B	Bushing on rod end (only for design »M«, »S« & »T«)
M	Thread M4 at rod end (only for design »M«, »S« & »T«)
V	Fluorelastomer seals for the sensor electronics housing

d	Stroke length
X X X X M	0025...7620 mm
Standard stroke length (mm)	Ordering steps
25... 500 mm	5 mm
500... 750 mm	10 mm
750...1000 mm	25 mm
1000...2500 mm	50 mm
2500...5000 mm	100 mm
5000...7620 mm	250 mm

X X X X U	001.0...300.0 in.
Standard stroke length (in.)	Ordering steps
1... 20 in.	0.2 in.
20... 30 in.	0.4 in.
30... 40 in.	1.0 in.
40...100 in.	2.0 in.
100...200 in.	4.0 in.
200...300 in.	10.0 in.

Non-standard stroke lengths are available; must be encoded in 5 mm/0.1 in. increments.

e	Number of magnets
X X	01...30 position(s) (1...30 magnet(s))

f	Connection type
D 5 8	2 × M12 female connectors (5 pin), 1 × M12 male connector (4 pin)

g	System
1	Standard

h	Output
U 4 0 1	PROFINET RT & IRT, position and velocity, encoder profile (1 position)
U 4 0 2	PROFINET RT & IRT, position and velocity, MTS profile (1...30 position(s))
U 4 1 1	PROFINET RT & IRT, position and velocity, encoder profile, internal linearization (1 position)
U 4 1 2	PROFINET RT & IRT, position and velocity, MTS profile, internal linearization (1...30 position(s))

#### NOTICE

- Select the MTS profile (U402 or U412) in **h** "Output" for multi-position measurement.
- Specify the number of magnets for your application and order the magnets separately.
- The number of magnets is limited by the stroke length. The minimum allowed distance between magnets (i.e. front face of one to the front face of the next one) is 75 mm (3 in.).
- Use magnets of the same type for multi-position measurement, e.g. 2 × U-magnet (part no. 251 416-2).
- If the option for internal linearization (U411, U412) in **h** "Output" is chosen, select a suitable magnet.

### 3.3 Nameplate

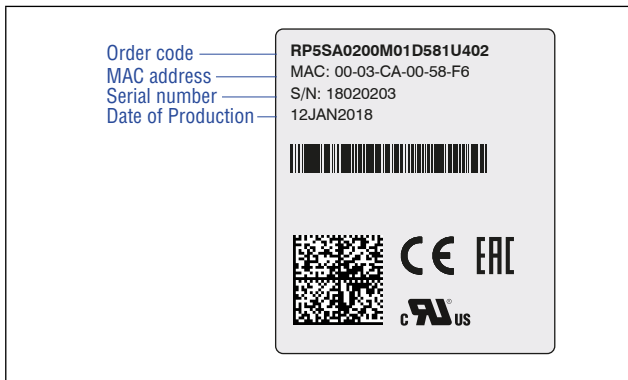

Fig. 1: Example of nameplate of a R-Series V RP5 sensor with PROFINET output

### 3.4 Approvals

- CE certified
- EAC certified
- PI certified
- UL certified

### 3.5 Scope of delivery

#### RP5 (profile sensor):

- Sensor
- Position magnet (not valid for RP5 with design »0«)
- 2 mounting clamps up to 1250 mm (50 in.) stroke length +  
1 mounting clamp for each 500 mm (20 in.) additional stroke length

#### RH5 (rod sensor):

- RH5-B: Base unit, 3 socket screws M4
- RH5-J/M/S/T: Sensor, O-ring

## 4. Product description and commissioning

### 4.1 Functionality and system design

#### Product designation

- Position sensor Temposonics® R-Series V

#### Sensor model

- Temposonics® R-Series V RP5 (profile sensor)
- Temposonics® R-Series V RH5 (rod sensor)

#### Stroke length

- Temposonics® R-Series V RP5: 25...6350 mm (1...250 in.)
- Temposonics® R-Series V RH5: 25...7620 mm (1...300 in.)

#### Output signal

- PROFINET RT & IRT

#### Application

The Temposonics® position sensors are used for measurement and conversion of the length (position) variable in the fields of automated systems and mechanical engineering.

#### Principle of operation and system construction

The absolute, linear position sensors provided by MTS Sensors rely on the company's proprietary Temposonics® magnetostrictive technology, which can determine position with a high level of precision and robustness. Each Temposonics® position sensor consists of a ferromagnetic waveguide, a position magnet, a strain pulse converter and supporting electronics. The magnet, connected to the object in motion in the application, generates a magnetic field at its location on the waveguide. A short current pulse is applied to the waveguide. This creates a momentary radial magnetic field and torsional strain on the waveguide. The momentary interaction of the magnetic fields releases a torsional strain pulse that propagates the length of the waveguide. When the ultrasonic wave reaches the end of the waveguide it is converted into an electrical signal. Since the speed of the ultrasonic wave in the waveguide is precisely known, the time required to receive the return signal can be converted into a linear position measurement with both high accuracy and repeatability.

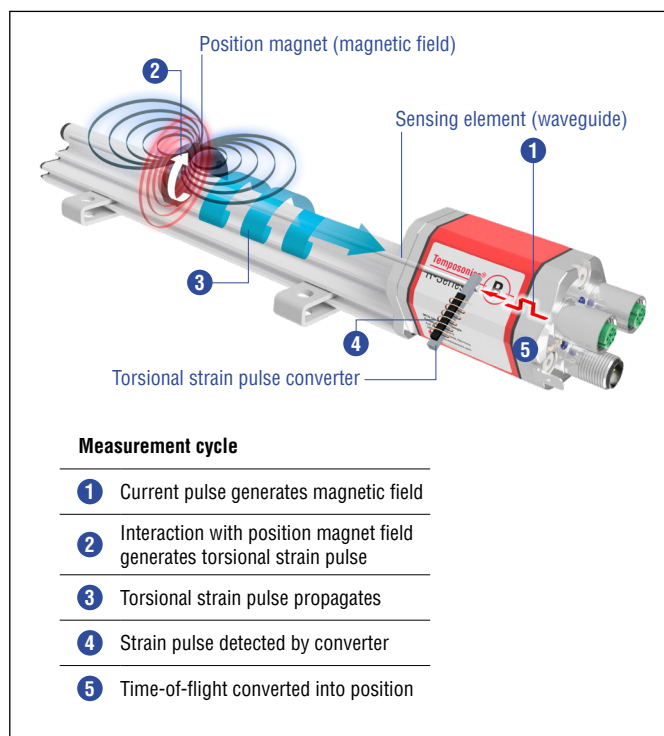

Fig. 2: Time-based magnetostrictive position sensing principle

#### Modular mechanical and electronic construction

- The sensor rod or profile protects the inner sensor element.
- The sensor electronics housing, a rugged aluminum construction, contains the complete electronic interface with active signal conditioning. Double shielding ensures high safety of operation and optimum EMC (Electromagnetic Compatibility).
- The external position magnet is a permanent magnet. Mounted on the mobile machine part, it travels along the sensor rod or profile and triggers the measurement through the sensor rod wall.
- The sensor can be connected directly to a control system. Its electronics generates a strictly position-proportional signal output between start and end position.

## 4.2 Styles and installation of Temposonics® RP5

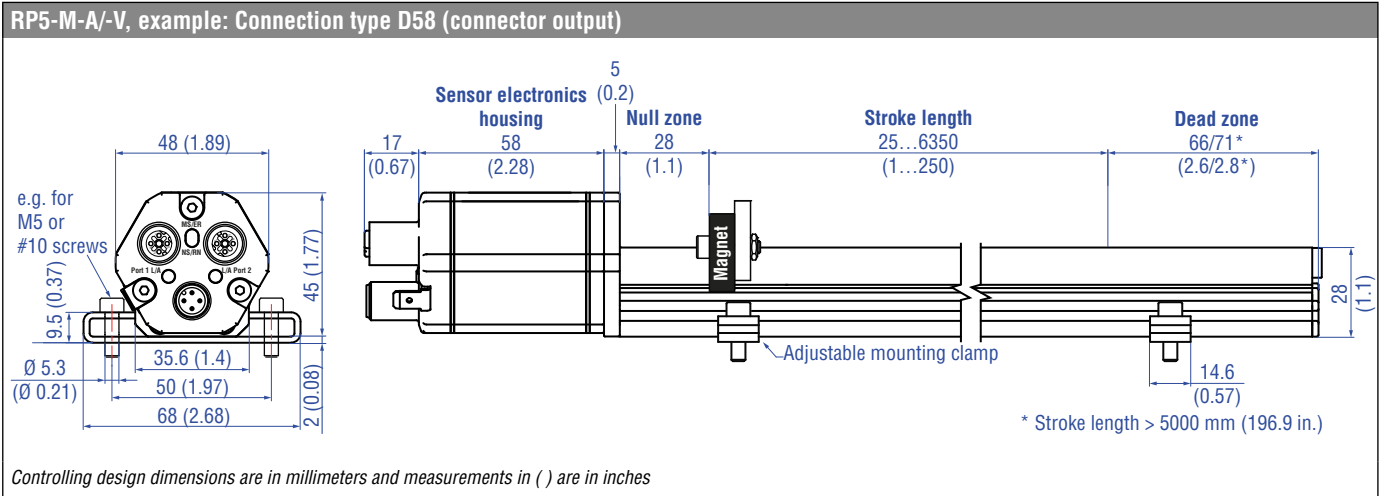

Fig. 3: Temposonics® RP5 with U-magnet

### Installation of RP5

The position sensor can be installed in any position. Normally, the sensor is firmly installed and the position magnet is fastened to the mobile machine part. Thus it can travel along the sensor profile. The sensor is fitted on a flat machine surface using the mounting clamps (Fig. 4). A length-dependent number of these clamps are delivered with the sensor and must be distributed over the profile at regular distances. For fastening use M5×20 screws to DIN 6912 that should be tightened with a fastening torque of 5 Nm.

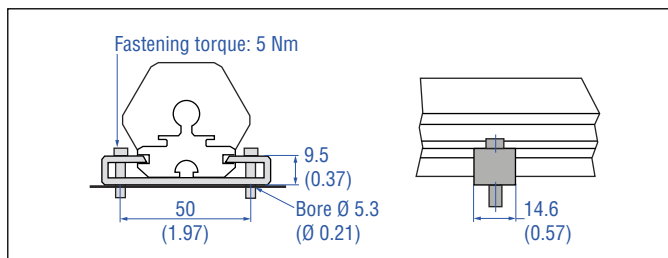

Fig. 4: Mounting clamps (part no. 400 802) with cylinder screw M5×20

### Alternative:

If only limited space is available, the profile sensor can be mounted also via the T-rail in the profile bottom using an T-slot nut M5 (part no. 401 602) or a sliding block (Fig. 5).

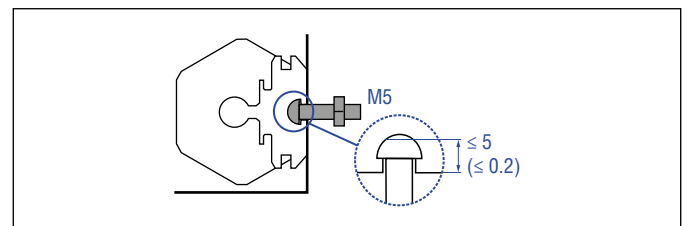

Fig. 5: T-slot nut M5 (part no. 401 602)

### NOTICE

Take care to mount the sensor in an axially parallel position to avoid damage to magnet and sensor.

4.3 Styles and installation of Temposonics® RH5

RH5-M/S-A-V – RH5 with threaded flange M18×1.5-6g or ¾"-16 UNF-3A, connection type D58 (connector output)

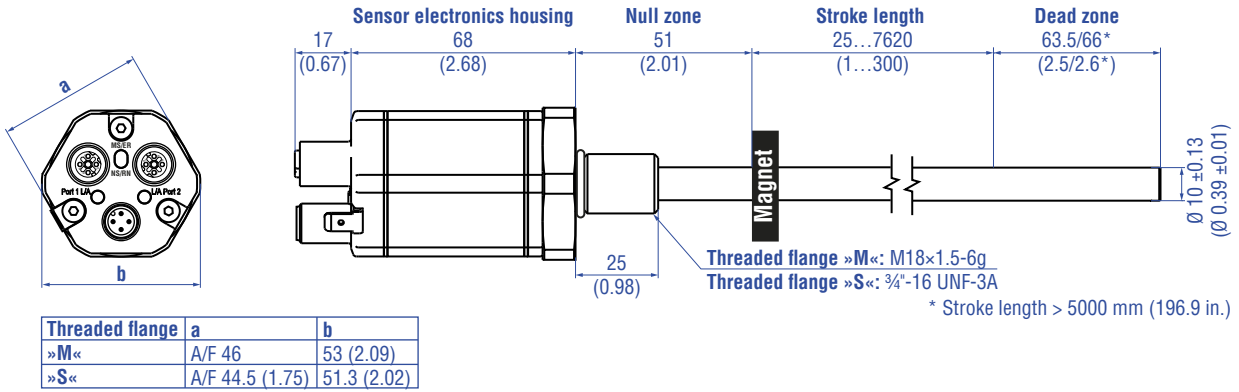

RH5-T-A-V – RH5 with threaded flange ¾"-16 UNF-3A with raised-face, connection type D58 (connector output)

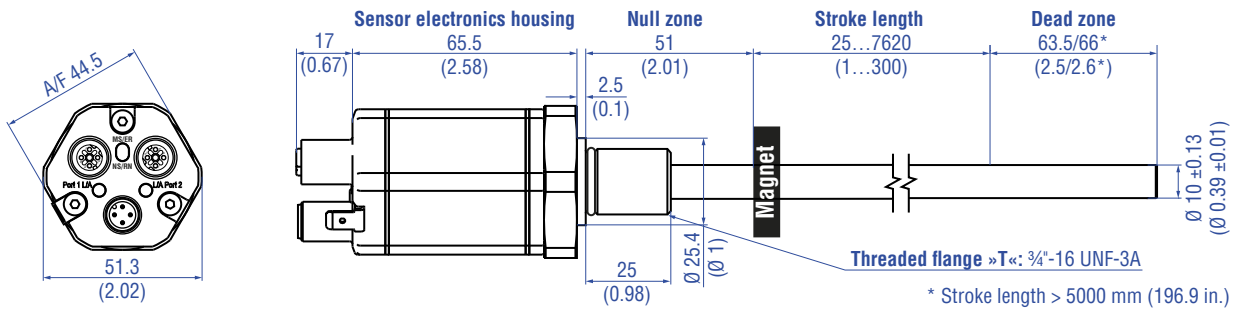

Mechanical option »B«: Bushing on rod end for threaded flange M18×1.5-6g or ¾"-16 UNF-3A

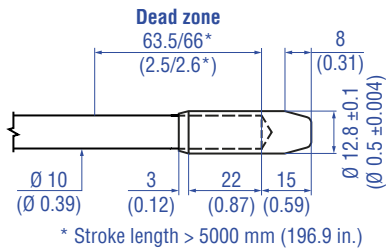

Mechanical option »M«: Thread M4 at rod end for threaded flange M18×1.5-6g or ¾"-16 UNF-3A

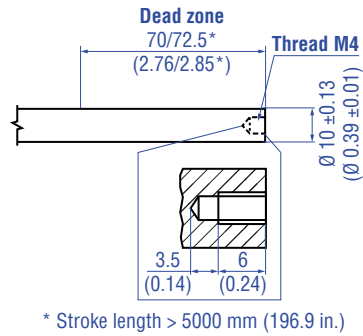

Controlling design dimensions are in millimeters and measurements in ( ) are in inches

Fig. 6: Temposonics® RH5 with ring magnet, part 1

**RH5-J-A/-V – RH5 with threaded flange M22×1.5-6g and Ø 12.7 mm rod, connection type D58 (connector output)**

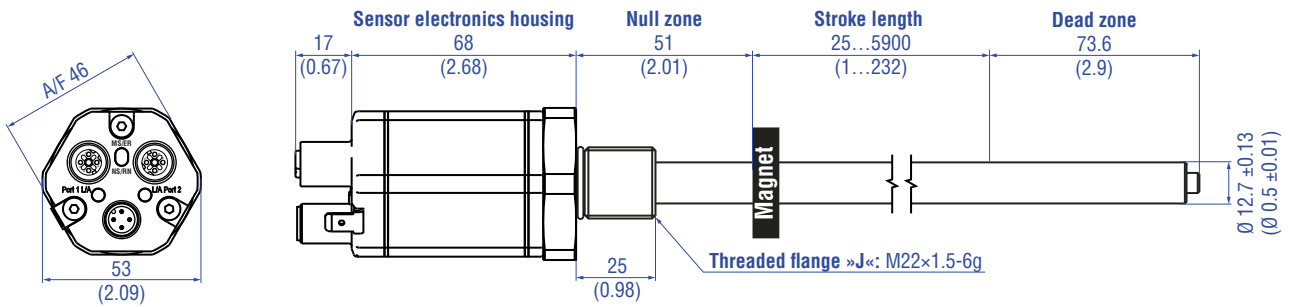

**RH5-B-A/-V – RH5 base unit (only for replacement), connection type D58 (connector output)**

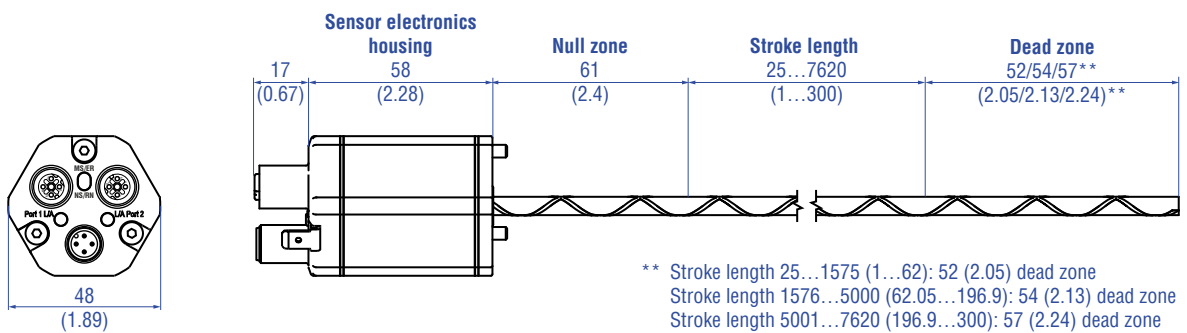

Controlling design dimensions are in millimeters and measurements in ( ) are in inches

Fig. 7: Temposonics® RH5 with ring magnet, part 2

**Installation of RH5 with threaded flange**

Fix the sensor rod via threaded flange M18×1.5-6g, M22×1.5-6g or 3/4"-16 UNF-3A.

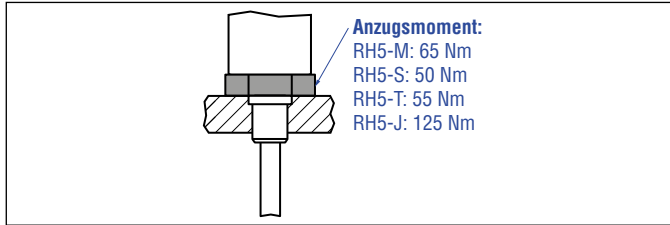

Fig. 8: Mounting example of threaded flange

**Installation in a fluid cylinder**

The rod-style version has been developed for direct stroke measurement in a fluid cylinder. Mount the sensor via threaded flange or a hex nut.

- Mounted on the face of the piston, the position magnet travels over the rod without touching it and indicates the exact position through the rod wall – independent of the hydraulic fluid.
- The pressure resistant sensor rod is installed into a bore in the piston rod.
- The base unit is mounted by means of three screws. It is the only part that needs to be replaced if servicing is required, i.e. the hydraulic circuit remains closed. For more information see chapter "4.6 Replacement of sensor" on page 16.

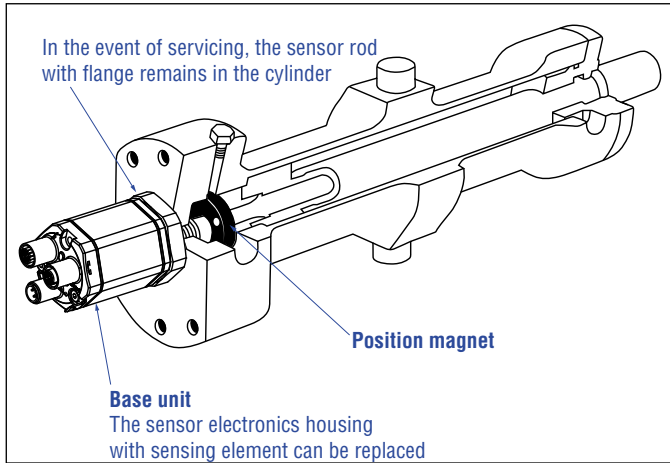

Fig. 9: Sensor in cylinder

**Hydraulics sealing**

There are two ways to seal the flange contact surface (Fig. 10):

1. A sealing by using an O-ring (e.g. 22.4 × 2.65 mm (0.88 × 0.1 in.), 25.07 × 2.62 mm (0.99 × 0.1 in.)) in a cylinder bottom groove.
2. A sealing by using an O-ring in the undercut.

For threaded flange (3/4"-16 UNF-3A):

O-ring 16.4 × 2.2 mm (0.65 × 0.09 in.) (part no. 560 315)

For threaded flange (M18×1.5-6g):

O-ring 15.3 × 2.2 mm (0.60 × 0.09 in.) (part no. 401 133)

For threaded flange (M22×1.5-6g):

O-ring 19.2 × 2.2 mm (0.76 × 0.09 in.) (part no. 561 337)

In the case of threaded flange M18×1.5-6g or M22×1.5-6g, provide a screw hole based on ISO 6149-1 (Fig. 11). See ISO 6149-1 for further information.

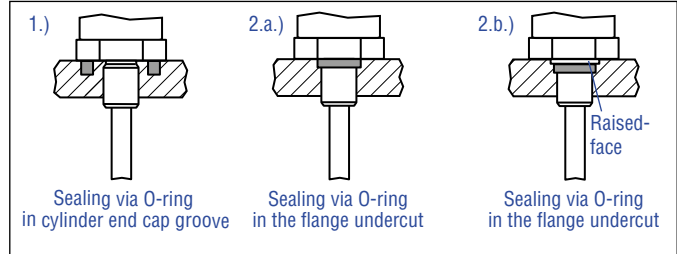

Fig. 10: Possibilities of sealing for threaded flange with flat face 1. + 2.a. (RH5-J/-M/-S) and with raised-face 2.b. (RH5-T)

- Note the fastening torque:  
RH5-M/S: 65 Nm  
RH5-S: 50 Nm  
RH5-T: 55 Nm  
RH5-J: 125 Nm
- Seat the flange contact surface completely on the cylinder mounting surface.
- The cylinder manufacturer determines the pressure-resistant gasket (copper gasket, O-ring, etc.).
- The position magnet should not grind on the sensor rod.
- The piston rod drilling (RH5-M/S/T-A/M/V with rod Ø 10 mm: ≥ Ø 13 mm (≥ Ø 0.51 in.); RH5-M/S/T-B with rod Ø 10 mm: ≥ Ø 16 mm (≥ Ø 0.63 in.); RH5-J-A/V with rod Ø 12.7 mm: ≥ Ø 16 mm (≥ Ø 0.63 in.)) depends on the pressure and piston speed.
- Adhere to the information relating to operating pressure.
- Protect the sensor rod against wear.

Notice for metric threaded flanges									
Thread (d <sub>1</sub> × P)	d <sub>2</sub>	d <sub>3</sub>	d <sub>4</sub>	d <sub>5</sub> +0.1 0	L <sub>1</sub> +0.4 0	L <sub>2</sub>	L <sub>3</sub>	L <sub>4</sub>	Z° ±1°
<b>RH5-M-A/V</b>									
M18×1.5-6g	55	≥ 13	24.5	19.8	2.4	28.5	2	26	15°
<b>RH5-M-B</b>									
M18×1.5-6g	55	≥ 16	24.5	19.8	2.4	28.5	2	26	15°
<b>RH5-J-A/V</b>									
M22×1.5-6g	55	≥ 16	27.5	23.8	2.4	28.5	2	26	15°

Fig. 11: Notice for metric threaded flange M18×1.5-6g/M22×1.5-6g based on DIN ISO 6149-1



#### 4.4 Magnet installation

##### Typical use of magnets





Magnet	Typical sensors	Benefits
 <b>Ring magnets</b>	<b>Rod model</b> (RH5)	<ul style="list-style-type: none"> <li>Rotationally symmetrical magnetic field</li> </ul>
 <b>U-magnets</b>	<b>Profile &amp; rod models</b> (RP5, RH5)	<ul style="list-style-type: none"> <li>Height tolerances can be compensated, because the magnet can be lifted off</li> </ul>
 <b>Block magnets</b>	<b>Profile &amp; rod models</b> (RP5, RH5)	<ul style="list-style-type: none"> <li>Height tolerances can be compensated, because the magnet can be lifted off</li> </ul>
 <b>Magnet sliders</b>	<b>Profile models</b> (RP5)	<ul style="list-style-type: none"> <li>The magnet is guided by the profile</li> <li>The distance between the magnet and the waveguide is strictly defined</li> <li>Easy coupling via the ball joint</li> </ul>

Fig. 12: Typical use of magnets

##### Mounting ring magnets, U-magnets & block magnets

Install the magnet using non-magnetic material for mounting device, screws, spacers etc.. The magnet must not grind on the sensor rod. Alignment errors are compensated via the air gap.

- Permissible surface pressure: Max. 40 N/mm<sup>2</sup> (only for ring magnets and U-magnets)
- Fastening torque for M4 screws: 1 Nm; use washers, if necessary
- Minimum distance between position magnet and any magnetic material has to be 15 mm (0.6 in.) (Fig. 15).
- If no other option exists and magnetic material is used, observe the specified dimensions (Fig. 15).

##### NOTICE

Mount ring magnets and U-magnets concentrically. Mount block magnets centrally over the sensor rod or the sensor profile. The maximum permissible air gap must not be exceeded (Fig. 13/ Fig. 14). Take care to mount the primary sensor axis in parallel to the magnet path in order to avoid damage to the carriage, magnet and sensor rod/sensor profile.

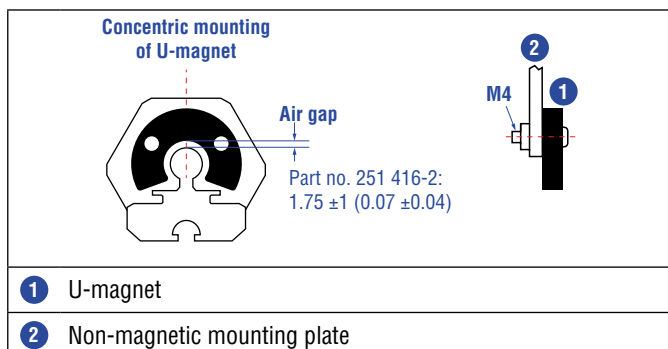

Fig. 13: Mounting of U-magnet (part no. 251 416-2)

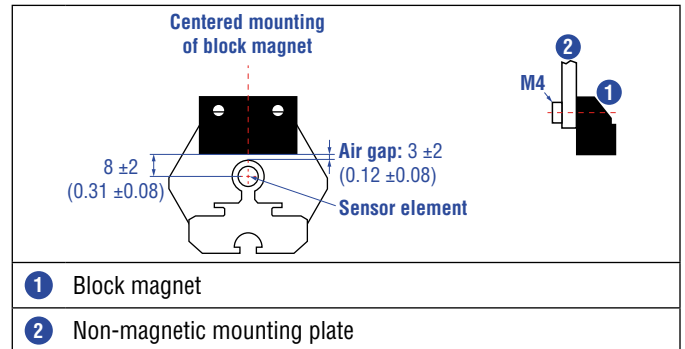

Fig. 14: Mounting of block magnet (part no. 403 448)

##### Magnet mounting with magnetic material

When using magnetic material the dimensions of Fig. 15 must be observed.

- A.** If the position magnet aligns with the drilled piston rod
- B.** If the position magnet is set further into the drilled piston rod, install another non-magnetic spacer (e.g. part no. 400 633) above the magnet.

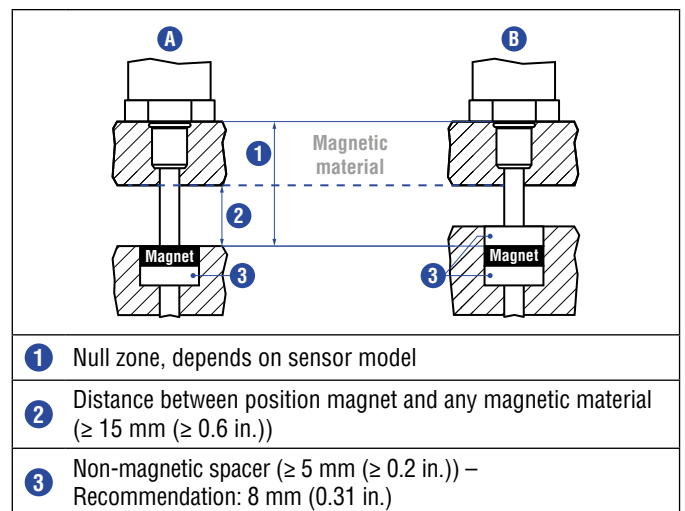

Fig. 15: Installation with magnetic material

##### Rod sensors with stroke lengths ≥ 1 meter (3.3 ft.)

Support horizontally installed sensors with a stroke length from 1 meter (3.3 ft.) mechanically at the rod end. Without the use of a support, rod and position magnet may be damaged. A false measurement result is also possible. Longer rods require evenly distributed mechanical support over the entire length (e.g. part no. 561 481). Use an U-magnet (Fig. 16) for measurement.

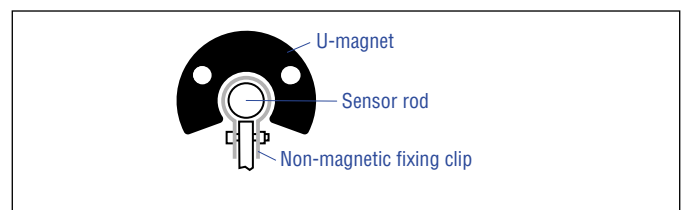

Fig. 16: Example of sensor support (part no. 561 481)

Controlling design dimensions are in millimeters and measurements in ( ) are in inches

### Start- and end positions of the position magnets

Consider the start and end positions of the position magnets during the installation. To ensure that the entire stroke length is electrically usable, the position magnet must be mechanically mounted as follows.

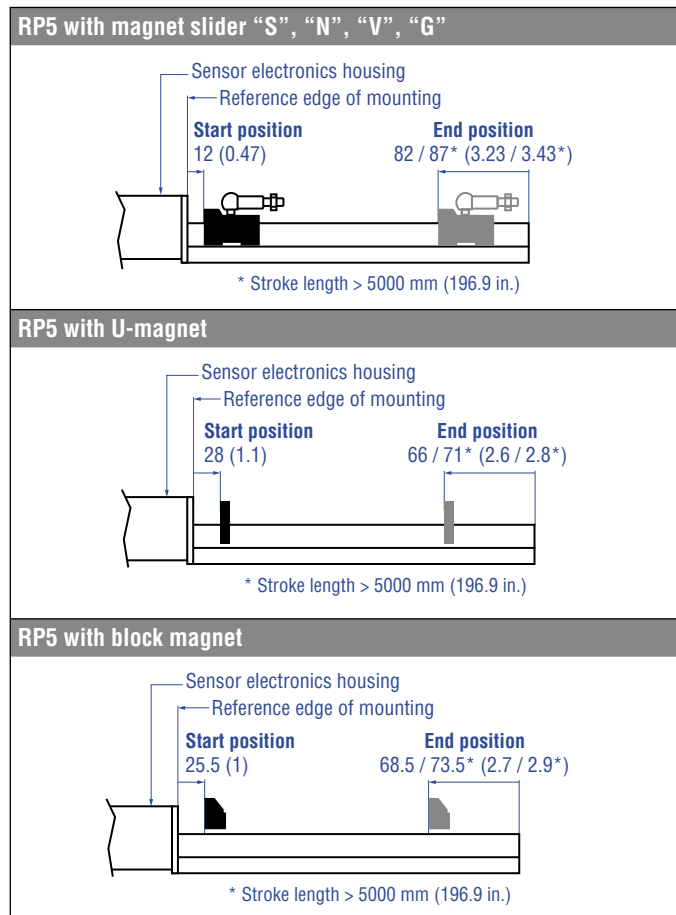

Fig. 17: Start- & end positions of magnets, part 1

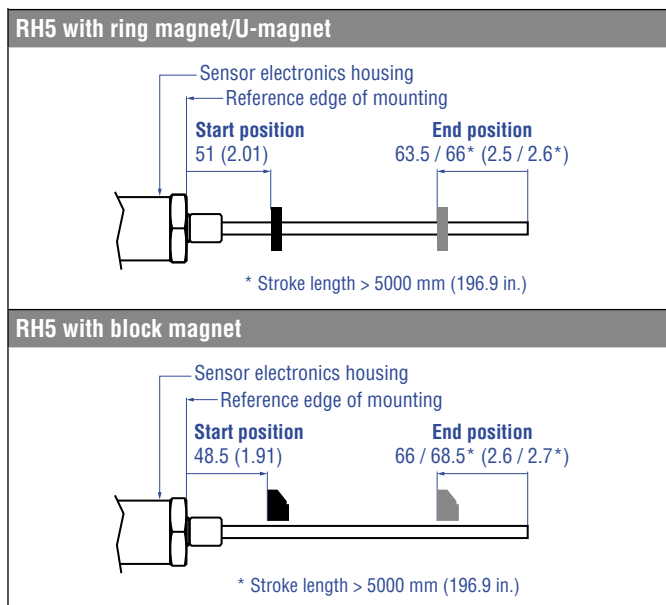

Fig. 18: Start- & end positions of magnets, part 2

### NOTICE

On all sensors, the areas left and right of the active stroke length are provided for null and dead zone. These zones should not be used for measurement, however the active stroke length can be exceeded.

### Multi-position measurement

The minimum distance between the magnets is 75 mm (3 in.).

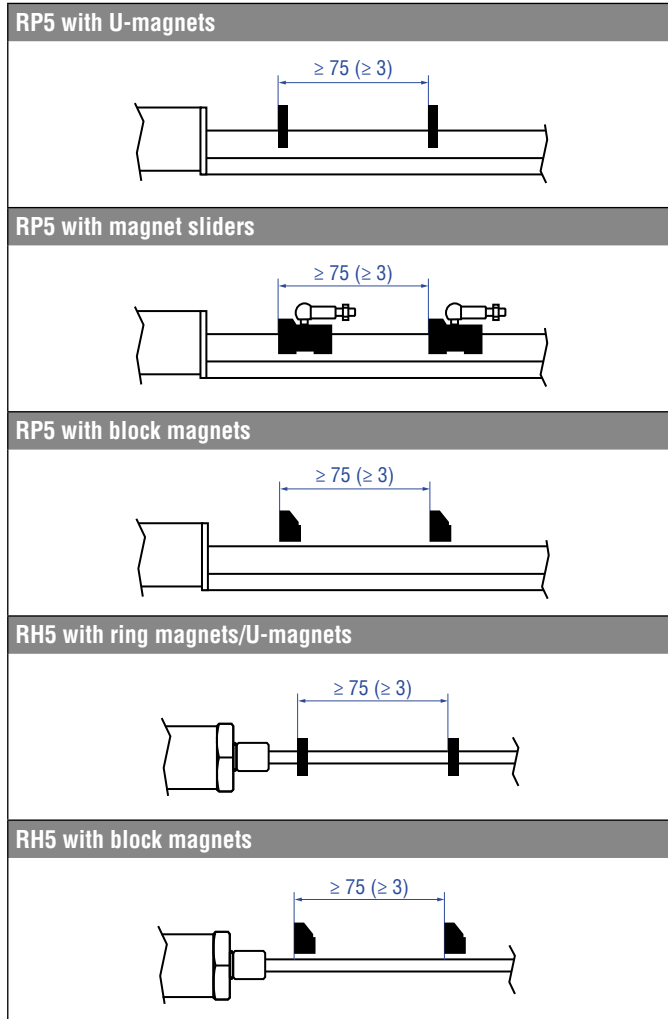

Fig. 19: Minimum distance for multi-position measurement

#### NOTICE

For multi-position measurement, use magnets of the same type e.g. 2 × U-magnet (part no. 251 416-2). Do not fall below the minimum distance between the magnets of 75 mm (3 in.) for multi-position measurement. Contact MTS Sensors if you need a magnet distance < 75 mm (3 in.).

### 4.5 Alignment of the magnet with the option “Internal linearization”

The internal linearization offers improved linearity of the sensor. The option must be specified in the order code of the sensor. The internal linearization is set for the sensor during production.

A sensor with internal linearization is delivered with the magnet with which the sensor was calibrated during production. In order to achieve the best possible result, MTS Sensors recommends to operate the sensor with the supplied magnet.

For the internal linearization, the following magnets can be used:

- Ring magnet OD33 (part no. 253 620), only for RH5
- U-magnet OD33 (part no. 254 226)
- Ring magnet OD24.4 (part no. 253 621), only for RH5
- Magnet slider S (part no. 252 182), only for RP5
- Magnet slider N (part no. 252 183), only for RP5
- Magnet slider V (part no. 252 184), only for RP5
- Magnet slider G (part no. 253 421), only for RP5

The ring magnet and U-magnet will be marked for the internal linearization. During the installation, the magnets have to be aligned to the sensor electronic housing, see Fig. 20, Fig. 21 and Fig. 22.

#### For RH5 PROFINET sensors with ring magnet applies:

- Install the magnet until the marking on the magnet points to the sensor electronics housing.
- The marking on the magnet points to the same direction as the elongated status LED in the lid of the sensor electronics housing.

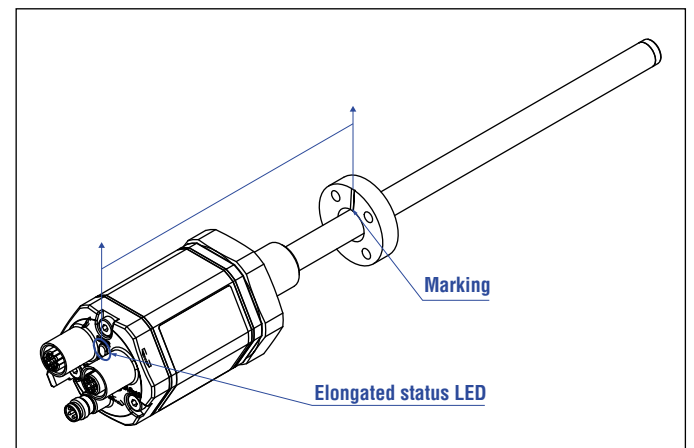

Fig. 20: Alignment of the ring magnet on the RH5 PROFINET with internal linearization

**For RP5 PROFINET sensors with the U-magnet applies:**

- Install the magnet until the marking on the magnet points to the sensor electronics housing.
- The marking on the magnet points to the same direction as the elongated status LED in the lid of the sensor electronics housing.

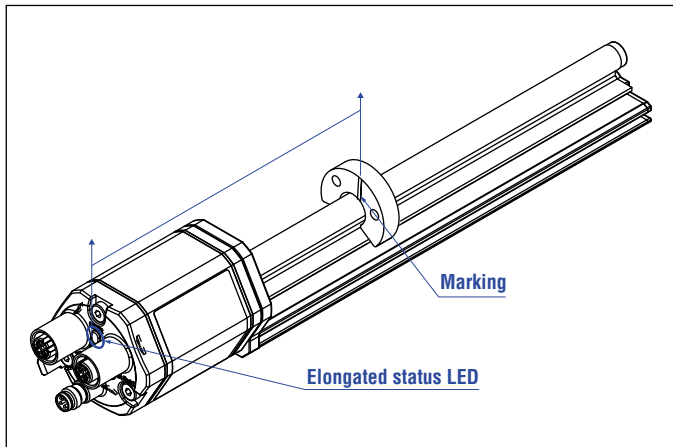

Fig. 21: Magnet alignment of U-magnet for RP5 PROFINET with internal linearization

**For RP5 PROFINET sensors with magnet slider applies:**

- ① Install the magnet sliders "S", "N" and "G" until the additional hole in the magnet points towards the sensor electronics housing.
- ② Install the magnet slider "V" until the joint points to the end of the profile.

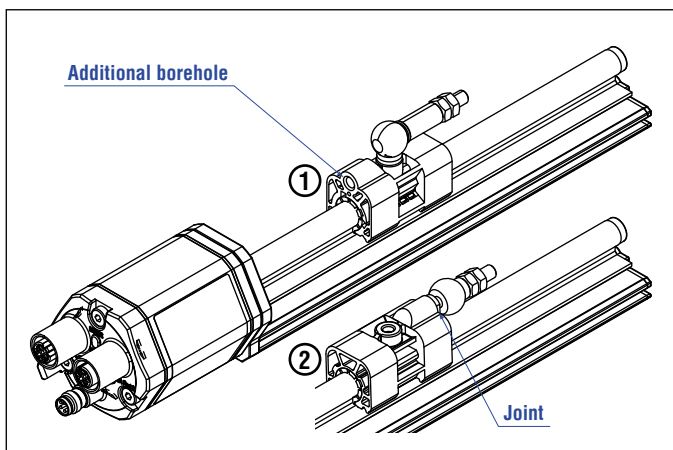

Fig. 22: Magnet alignment of magnet slider for RP5 PROFINET with internal linearization

**The internal linearization of the sensor is carried out under the following conditions:**

- Supply voltage +24 VDC ±0.5
- Operating time > 30 min
- No shock and no vibration
- Eccentricity of the position magnet to central axis of the sensor < 0.1 mm

**NOTICE**

The generated linearization might deviate from the linearity tolerances regarding different environmental conditions. In addition, the use of a different position magnet or more position magnets may cause differences.

**4.6 Replacement of sensor**

The base unit of the sensor model RH5-B is replaceable as shown in Fig. 23 and Fig. 24 for the sensor designs »M«, »S« and »T«. The sensor can be replaced without interrupting the hydraulic circuit.

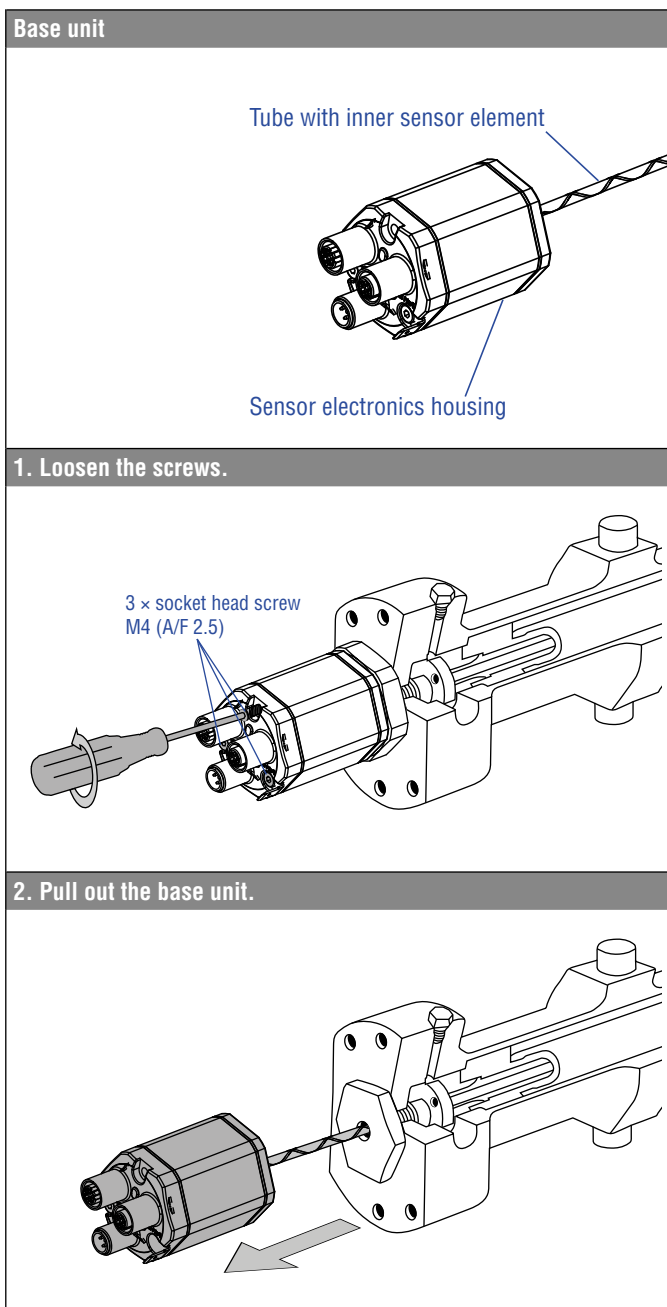

Fig. 23: Replacement of the base unit (e.g. RH5 sensor), part 1

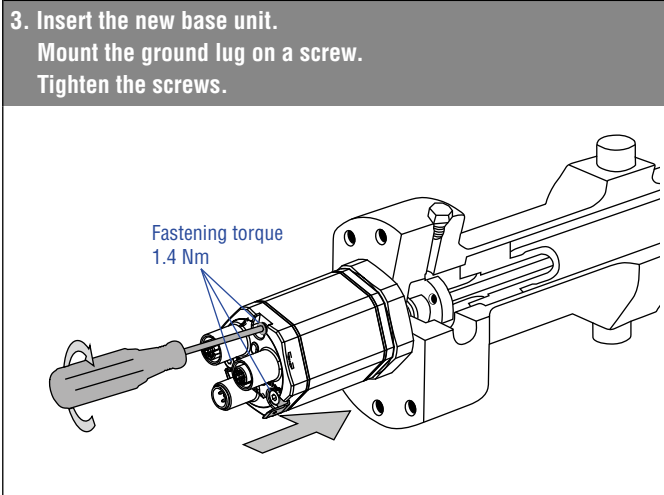

Fig. 24: Replacement of the base unit (e.g. RH5 sensor), part 2

**NOTICE**

- When replacing the base unit, make sure that no humidity enters the sensor tube. This may damage the sensor.
- Secure the base unit screws, e.g. using Loctite 243, before re-installing.
- If the R-Series V replaces a predecessor model of the R-Series, the plastic tube in the sensor rod must be removed.

#### 4.7 Electrical connections

Placement of installation and cabling have decisive influence on the sensor's electromagnetic compatibility (EMC). Hence correct installation of this active electronic system and the EMC of the entire system must be ensured by using suitable metal connectors, shielded cables and grounding. Overvoltages or faulty connections can damage its electronics despite protection against wrong polarity.

#### NOTICE

1. Do not mount the sensors in the area of strong magnetic or electric noise fields.
2. Never connect/disconnect the sensor when voltage is applied.

#### Instructions for connection

- Use low-resistant twisted pair and shielded cables. Connect the shield to ground externally via the controller equipment.
- Keep control and signal cables separate from power cables and sufficiently far away from motor cables, frequency inverters, valve lines, relays, etc..
- Use only connectors with metal housing and connect the shielding to the connector housing.
- Keep the connection surface at both shielding ends as large as possible. Connect the cable clamps to function as a ground.
- Keep all non-shielded leads as short as possible.
- Keep the earth connection as short as possible with a large cross section. Avoid ground loops.
- With potential differences between machine and electronics earth connections, no compensating currents are allowed to flow across the cable shielding.

#### Recommendation:

Install potential compensating leads with large cross section, or use cables with separate double shielding, and connect only one end of the shield.

- Use only stabilized power supplies in compliance with the specified electrical ratings.

#### Grounding of profile and rod sensors

Connect the sensor electronics housing to machine ground. Ground sensor types RP5 and RH5 via ground lug as shown in Fig. 25. In addition you can ground the sensor type RH5 via thread.

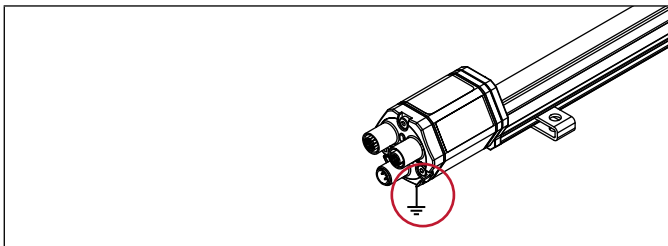

Fig. 25: Grounding via ground lug (e.g. RP5)

#### Connector wiring

Connect the sensor directly to the control system, indicator or other evaluating systems as follows:

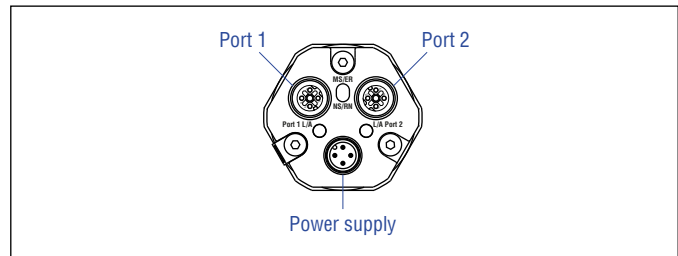
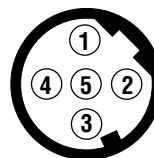

Fig. 26: Location of connections

#### D58

##### Port 1 – Signal

##### M12 female connector (D-coded)



View on sensor

Pin	Function
1	Tx (+)
2	Rx (+)
3	Tx (-)
4	Rx (-)
5	Not connected

##### Port 2 – Signal

##### M12 female connector (D-coded)

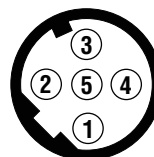

View on sensor

Pin	Function
1	Tx (+)
2	Rx (+)
3	Tx (-)
4	Rx (-)
5	Not connected

##### Power supply

##### M12 male connector (A-coded)

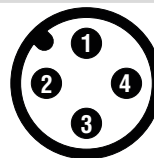

View on sensor

Pin	Function
1	+12...30 VDC ( $\pm 20\%$ )
2	Not connected
3	DC Ground (0 V)
4	Not connected

Fig. 27: Connector wiring D58

4.8 Frequently ordered accessories for RP5 design – Additional options available in our [Accessories Guide](#) 551 444

Position magnets

<p><b>Magnet slider S, joint at top</b> Part no. 252 182</p> <p>Material: GRP, magnet hard ferrite Weight: Approx. 35 g Operating temperature: -40...+85 °C (-40...+185 °F)</p>	<p><b>Magnet slider V, joint at front</b> Part no. 252 184</p> <p>Material: GRP, magnet hard ferrite Weight: Approx. 35 g Operating temperature: -40...+85 °C (-40...+185 °F)</p>	<p><b>Magnet slider N longer ball-joint arm</b> Part no. 252 183</p> <p>Material: GRP, magnet hard ferrite Weight: Approx. 35 g Operating temperature: -40...+85 °C (-40...+185 °F)</p>	<p><b>Magnet slider G, backlash free</b> Part no. 253 421</p> <p>Material: GRP, magnet hard ferrite Weight: Approx. 25 g Operating temperature: -40...+85 °C (-40...+185 °F)</p>

Position magnets

Mounting accessories

<p><b>U-magnet OD33</b> Part no. 251 416-2</p> <p>Material: PA ferrite GF20 Weight: Approx. 11 g Surface pressure: Max. 40 N/mm<sup>2</sup> Fastening torque for M4 screws: 1 Nm Operating temperature: -40...+105 °C (-40...+221 °F)</p> <p>Marked version for sensors with internal linearization: Part no. 254 226</p>	<p><b>Block magnet L</b> Part no. 403 448</p> <p>Material: Plastic carrier with hard ferrite magnet Weight: Approx. 20 g Fastening torque for M4 screws: 1 Nm Operating temperature: -40...+75 °C (-40...+167 °F) This magnet may influence the sensor performance specifications for some applications.</p>	<p><b>Mounting clamp</b> Part no. 400 802</p> <p>Material: Stainless steel (AISI 304)</p>	<p><b>T-nut</b> Part no. 401 602</p> <p>Fastening torque for M5 screw: 4.5 Nm</p>

4.9 Frequently ordered accessories for RH5 design – Additional options available in our [Accessories Guide](#) 551 444

Position magnets

<p><b>U-magnet OD33</b> <b>Part no. 251 416-2</b></p> <p>Material: PA ferrite GF20 Weight: Approx. 11 g Surface pressure: Max. 40 N/mm<sup>2</sup> Fastening torque for M4 screws: 1 Nm Operating temperature: -40...+105 °C (-40...+221 °F)</p> <p>Marked version for sensors with internal linearization: Part no. 254 226</p>	<p><b>Ring magnet OD33</b> <b>Part no. 201 542-2</b></p> <p>Material: PA ferrite GF20 Weight: Approx. 14 g Surface pressure: Max. 40 N/mm<sup>2</sup> Fastening torque for M4 screws: 1 Nm Operating temperature: -40...+105 °C (-40...+221 °F)</p> <p>Marked version for sensors with internal linearization: Part no. 253 620</p>	<p><b>Ring magnet OD25.4</b> <b>Part no. 400 533</b></p> <p>Material: PA ferrite Weight: Approx. 10 g Surface pressure: Max. 40 N/mm<sup>2</sup> Operating temperature: -40...+105 °C (-40...+221 °F)</p> <p>Marked version for sensors with internal linearization: Part no. 253 621</p>	<p><b>Ring magnet</b> <b>Part no. 402 316</b></p> <p>Material: PA ferrite coated Weight: Approx. 13 g Surface pressure: Max. 20 N/mm<sup>2</sup> Operating temperature: -40...+100 °C (-40...+212 °F)</p>

Position magnet

Magnet spacer

O-rings

<p><b>Block magnet L</b> <b>Part no. 403 448</b></p> <p>Material: Plastic carrier with hard ferrite magnet Weight: Approx. 20 g Fastening torque for M4 screws: 1 Nm Operating temperature: -40...+75 °C (-40...+167 °F)</p> <p>This magnet may influence the sensor performance specifications for some applications.</p>	<p><b>Magnet spacer</b> <b>Part no. 400 633</b></p> <p>Material: Aluminum Weight: Approx. 5 g Surface pressure: Max. 20 N/mm<sup>2</sup> Fastening torque for M4 screws: 1 Nm</p>	<p><b>O-ring for threaded flange</b> <b>M18x1.5-6g</b> <b>Part no. 401 133</b></p> <p>Material: Fluoroelastomer Durometer: 75 ± 5 Shore A Operating temperature: -40...+204 °C (-40...+400 °F)</p>	<p><b>O-ring for threaded flange</b> <b>3/4"-16 UNF-3A</b> <b>Part no. 560 315</b></p> <p>Material: Fluoroelastomer Durometer: 75 ± 5 Shore A Operating temperature: -40...+204 °C (-40...+400 °F)</p>



O-ring



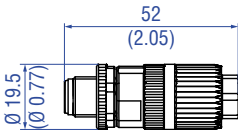
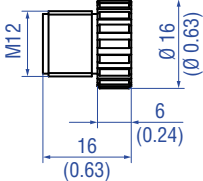
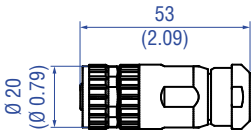

Mounting accessories

<p><b>O-ring for threaded flange</b> <b>M22x1.5-6g</b> <b>Part no. 561 337</b></p> <p>Material: FPM Durometer: 75 Shore A Operating temperature: -20...+200 °C (-6...+392 °F)</p>	<p><b>Hex jam nut M18x1.5-6g</b> <b>Part no. 500 018</b></p> <p>Material: Steel, zinc plated</p>	<p><b>Hex jam nut 3/4"-16 UNF-3A</b> <b>Part no. 500 015</b></p> <p>Material: Zinc plated</p>	<p><b>Fixing clip</b> <b>Part no. 561 481</b></p> <p>Application: Used to secure sensor rods (Ø 10 mm (Ø 0.39 in.)) when using an U-magnet or block magnet Material: Brass, non-magnetic</p>

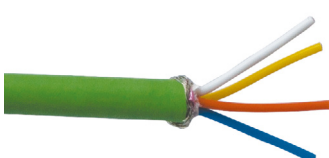

**4.10 Frequently ordered accessories for PROFINET output** – Additional options available in our [Accessories Guide](#) 551 444

Cable connectors*			Programming kit
			
<p><b>Signal connector M12 D-coded male (4 pin), straight</b> Part no. 370 523</p> <p>Material: Zinc nickel-plated Termination: Insulation-displacement Cable Ø: 5.5...7.2 mm (0.2...0.28 in.) Wire: 24 AWG – 22 AWG Operating temperature: –25...+85 °C (–13...+185 °F) Ingress protection: IP65 / IP67 (correctly fitted) Fastening torque: 0.6 Nm</p>	<p><b>Signal connector M12 end cap</b> Part no. 370 537</p> <p>Female connectors M12 should be covered by this protective cap Material: Brass nickel-plated Ingress protection: IP67 (correctly fitted) Fastening torque: 0.39...0.49 Nm</p>	<p><b>Power connector M12 A-coded female (5 pin), straight</b> Part no. 370 677</p> <p>Material: GD-Zn, Ni Termination: Screw Contact insert: CuZn Cable Ø: 4...8 mm (0.16...0.31 in.) Wire: 1.5 mm<sup>2</sup> Operating temperature: –30...+85 °C (–22...+185 °F) Ingress protection: IP67 (correctly fitted) Fastening torque: 0.6 Nm</p>	<p><b>TempoLink kit for Temposonics® R-Series V</b> Part no. TL-1-0-EM12 (for D58)</p> <ul style="list-style-type: none"> <li>• Connect wirelessly via Wi-Fi enabled device or via USB with the diagnostic tool</li> <li>• Simple connectivity to the sensor via 24 VDC power line (permissible cable length: 30 m)</li> <li>• User friendly interface for mobile devices and desktop computers</li> <li>• See data sheet “TempoLink smart assistant” (document part no.: 552070) for further information</li> </ul>

Cables			
			
<p><b>PUR signal cable</b> Part no. 530 125</p> <p>Material: PUR jacket; green Features: Cat 5, highly flexible, halogen free, energy chain capable, mostly oil &amp; flame resistant Cable Ø: 6.5 mm (0.26 in.) Cross section: 2 × 2 × 0.35 mm<sup>2</sup> (22 AWG) Operating temperature: –20...+60 °C (–4...+140 °F)</p>	<p><b>Signal cable with M12 D-coded male connector (4 pin), straight – M12 D-coded, male connector (4 pin), straight</b> Part no. 530 064</p> <p>Material: PUR jacket; green Features: Cat 5e Cable length: 5 m (16.4 ft) Cable Ø: 6.5 mm (0.26 in.) Ingress protection: IP65, IP67, IP68 (correctly fitted) Operating temperature: –30...+70 °C (–22...+158 °F)</p>	<p><b>Signal cable with M12 D-coded male connector (4 pin), straight – RJ45 male connector, straight</b> Part no. 530 065</p> <p>Material: PUR jacket; green Features: Cat 5e Cable length: 5 m (16.4 ft) Cable Ø: 6.5 mm (0.26 in.) Ingress protection M12 connector: IP67 (correctly fitted) Ingress protection RJ45 connector: IP20 (correctly fitted) Operating temperature: –30...+70 °C (–22...+158 °F)</p>	<p><b>PVC power cable</b> Part no. 530 108</p> <p>Material: PVC jacket; gray Features: Shielded, flexible, mostly flame resistant Cable Ø: 4.9 mm (0.19 in.) Cross section: 3 × 0.34 mm<sup>2</sup> Bending radius: 10 × D Operating temperature: –30...+80 °C (–22...+176 °F)</p>

\*/ Follow the manufacturer's mounting instructions

Controlling design dimensions are in millimeters and measurements in ( ) are in inches

## 5. Operation

### 5.1 Initial start-up

The position sensor R-Series V PROFINET transfers position and velocity values via the PROFINET output.

PROFINET was developed by the PROFIBUS & PROFINET International (PI) organization and is a standard for transmissions in Industrial Ethernet. The sensor and the corresponding GSDML file (General Device Description) are certified by the Profibus Nutzerorganisation e.V. (PNO).

The sensor can be ordered with different protocol options:

- Encoder profile (U401/U411): the encoder profile corresponds to the specification of the encoder profile V4.1 (PNO no. 3.162). With this profile, the position and the velocity of one position magnet can be measured and transferred simultaneously.
- MTS profile (U402/U412): The MTS profile was developed by MTS Sensors. With this profile, the position and the velocity of up to 30 position magnets can be measured and transferred simultaneously.

The R-Series V PROFINET supports both RT mode and IRT mode. With PROFINET RT (Real Time) the data exchange is without clock synchronization. In this case, the application, the data transmission and the field devices operate according to their own processing cycle. With PROFINET IRT (Isochronous Real Time) a clock-synchronous data transmission takes place. The application, the data transmission as well as the device cycle are synchronous. IRT enables a clock-synchronous data exchange with a minimum cycle time of 250 µs in the network.

### NOTICE

#### Observe during commissioning

1. Before initial switch-on, check carefully if the sensor has been connected correctly.
2. Position the magnet in the measuring range of the sensor during first commissioning and after replacement of the magnet.
3. Ensure that the sensor control system cannot react in an uncontrolled way when switching on.
4. Ensure that the sensor is ready and in operation mode after switching on. The bus status LED is green.
5. Check the preset span start and end values of the measuring range (see chapter 4.4) and correct them via the customer's control system, if necessary.

### 5.2 LED Status

A diagnostic display on the lid of the sensor informs about the current status of the sensor. The R-Series V is equipped with three LEDs:

- LED for status indication (condition indicator)
- LED for link activity of port 1 (port 1 L/A)
- LED for link activity of port 2 (port 2 L/A)

**PROFINET RT & IRT LED status**

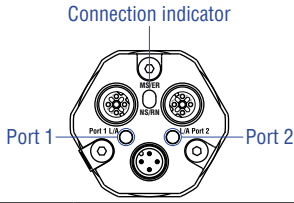

Connection indicator

Port 1 — Port 2

**Device status LED**

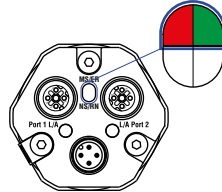

Green	Red	Information
● ON	○ OFF	No error
○ OFF	● ON	Operating voltage out of range or magnet error

**Bus status LED**

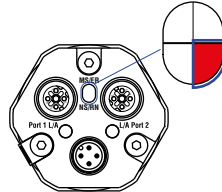

Red	Information
○ OFF	No error
● ON	No connection to controller
● Flashing	Parameterization error

**LED for sensor identification**

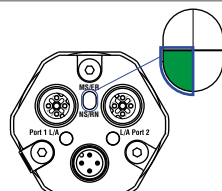

Green	Information
● Flashing	Sensor identification activated

Fig. 28: LED status, part 1

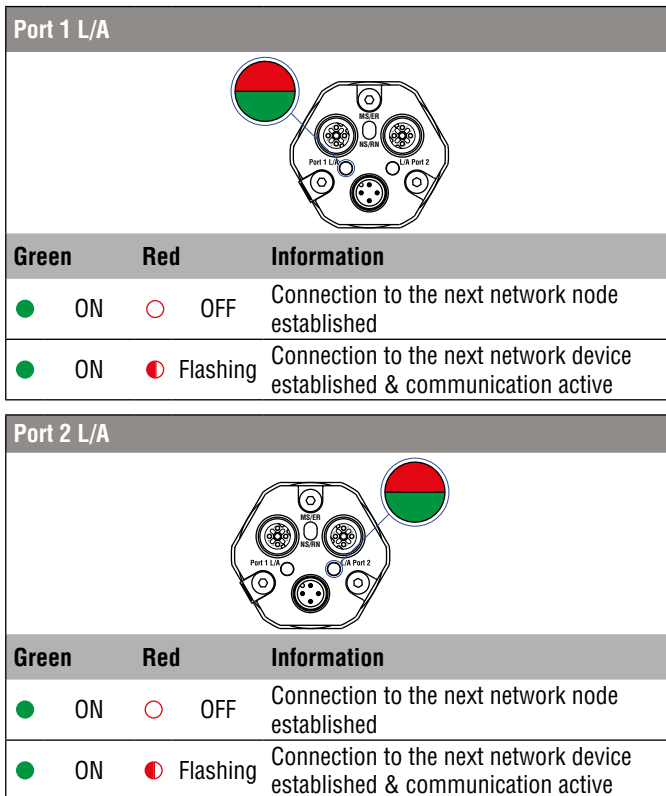

Fig. 29: LED status, part 2

### 5.3 Supported network functions

**Following network functions are supported:**

- RTC (Class 1 & Class 3) (Real Time Cyclic Protocol): Protocol for cyclic IO data (process data and measured values)
- RTA (Real Time Acyclic Protocol): Protocol for acyclic real time data (e.g. alarms)
- DCP (Discover and Basic Configuration Protocol): Assignment of IP configuration and device name
- DCE/RPC (Distributed Computing Environment Remote Procedure Call): Remote Procedure Calls via IP (e.g. parameter configuration)
- LLDP (Link Layer Discovery Protocol): Protocol used for neighborhood detection
- SNMP (Simple Network Management Protocol): Protocol used for network node diagnosis
- MRP (Media Redundancy Protocol): Searches for alternative routes in case of cable error or node error

### Supported network Topologies

PROFINET supports various topologies when building up a network. Thus, the usage of linear, star, ring and tree topologies are supported. For these topologies, switches are integrated in devices like the R-Series V PROFINET sensors. With integrated switches, a power failure will cause a communication interruption to the subsequent devices. This can be avoided, for example, by extending the line structure to a ring structure.

## 6. Programming and configuration in the TIA Portal

### 6.1 General Information

This instruction describes as an example the integration and programming of a Temposonics® R-Series V sensor with PROFINET into the TIA Portal (Totally Integrated Automation Portal) of Siemens AG. For controllers and software of other versions and manufacturers, the operation may differ.

**NOTICE**

Follow the information given in the controller operation manual.

Chapter 6.2 contains the integration and programming of the R-Series V PROFINET with MTS profile (U402/U412). The implementation and configuration of the R-Series V with encoder profile (U401/U411) is described in chapter 6.3.

### 6.2 Parameter description for MTS profile

After you have created a project, you can include the sensor via its GSDML file. The properties and functions of a PROFINET IO field device are described in a GSDML (General Station Description) file. The XML-based GSDML file contains all relevant data that is important for both the implementation of the device in the controller and the data exchange during operation.

The GSDML file for the R-Series V PROFINET is available on our homepage [www.mtssensors.com](http://www.mtssensors.com). The GSDML file of the R-Series V PROFINET is packed into a zip file containing the data for the MTS profile and encoder profile. Download the GSDML file and save it on your computer. To include the GSDML file, select "Tools" from the menu bar of the TIA portal and click on "Manage device description file (GSD)". The "Manage device description files" window opens (Fig. 30). Enter the source path where the R-Series V PROFINET with MTS profile GSDML file is stored. Specify the location and press the "Install" button to install the GSDML file. The default name of the R-Series V PROFINET sensor is "MTS-R-Series-PNIO-MF". This name can be changed.

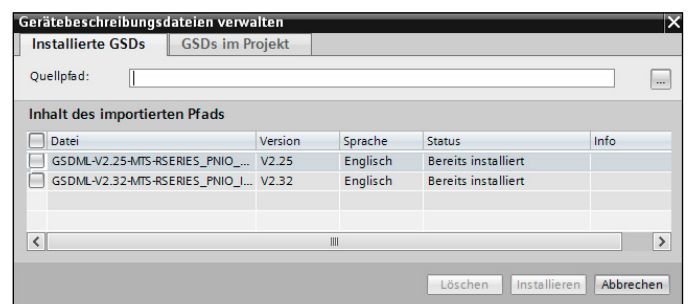

Fig. 30: The installed GSDML files

The R-Series V PROFINET supports both RT mode and IRT mode. The sensor is set to the respective mode during connection setup with the controller. By default, the sensor operates in RT mode. To operate the sensor in IRT mode, select the tab "General" in the section "Advanced options". Select RT class "IRT" in the sub-section "Real time settings". The IRT mode prioritizes the data packets (Fig. 31).

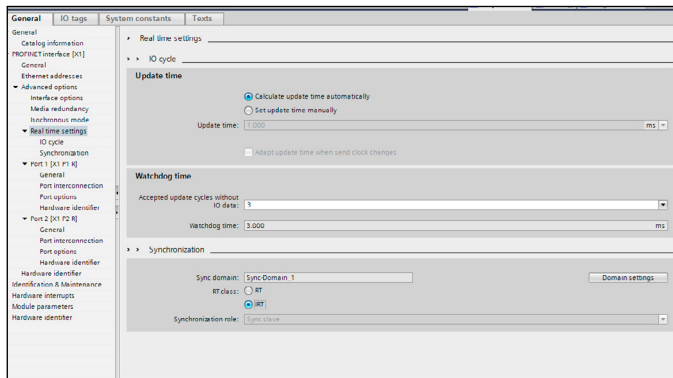

Fig. 31: Setting of the IRT mode

In order for the control unit to be able to access the sensor data isochronously, the isochronous mode in the "Advanced options" section of the "General" tab, has to be activated. This results in a synchronization to the transmission clock to the controller. By default, the isochronous mode is deactivated (Fig. 32).

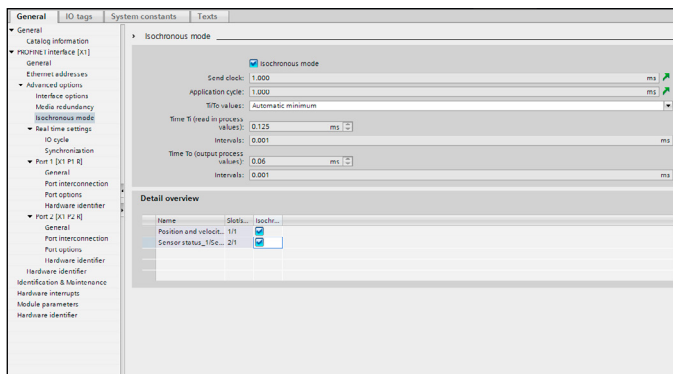

Fig. 32: Activation of isochronous control mode

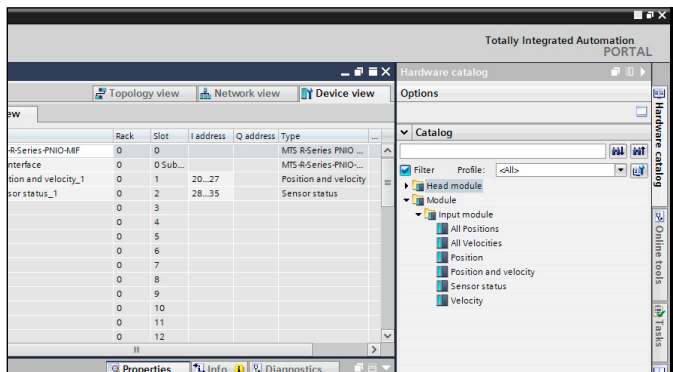

Fig. 33: Hardware Catalog

Different input modules are available for the R-Series V PROFINET with MTS profile. The following "Input modules" can be selected in the "Catalog" section:

- **All positions:** This module contains the positions of up to 30 magnets. The number of magnets shown in this module depends on the number of magnets specified in the parameter "Number of magnets". With this module, 160 bytes are always transferred. Each magnet is assigned 4 bytes for the position value (1<sup>st</sup> magnet: 0...3 bytes, 2<sup>nd</sup> magnet: 4...7, etc.). If less than 30 magnets are operated on the sensor the unused bytes written with "0".
- **All velocities:** This module contains the velocity of up to 30 magnets. The number of magnets shown in this module depends on the number of magnets specified in the parameter "Number of magnets". With this module, 160 bytes are always transferred. Each magnet is assigned 4 bytes for the velocity value (1<sup>st</sup> magnet: 0...3 bytes, 2<sup>nd</sup> magnet: 4...7, etc.). If less than 30 magnets are operated on the sensor, the unused bytes are written with "0".
- **Position:** This module contains the position of a magnet. Afterwards you must assign a magnet to this module.
- **Position and velocity:** This module contains the position and velocity of a magnet. This module transfers 8 bytes. The bytes 0...3 contain the position value and the bytes 4...7 contain the velocity value of the selected magnet. Afterwards you must assign a magnet to this module.
- **Sensor status:** This module shows the current status of the sensor:
  - Current power supply in mV
  - Number of magnets on the sensor rod
  - Bit mask for indicating which magnet number is detected on the sensor
- **Velocity:** This module contains the velocity of a magnet. Afterwards you must assign a magnet to this module.

Drag the selected module into the "Device Overview" window. While the "All positions" and "All velocities" modules contain up to 30 magnets, the "Position", "Velocity" and "Position and velocity" modules contain the values of only one magnet at a time. Therefore, a magnet must be assigned to these modules. This assignment is carried out in the "Module parameters" section of the "General" tab. Select a magnet for the selected module under "Position parameters". By default, all modules are assigned to magnet 1 (Fig. 34).

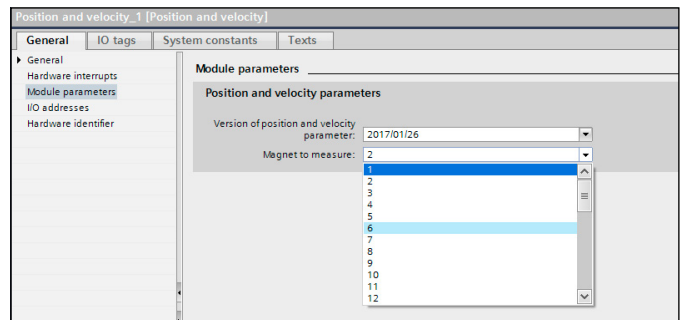

Fig. 34: Assignment of the magnets to the selected input modules

In the example shown, the R-Series V PROFINET sensor is assigned to slot 0 in the "Device Overview" tab. The parameters of the R-Series V PROFINET sensor are set in the sub-section "Module parameters" of the "General" tab. The following parameters can be adjusted in the "Sensor parameters" section (Fig. 38 and Fig. 39):

- **Resolution** (Setting of the resolution for position measurement)  
Possible values: 0.5 µm; 1 µm; 2 µm; 5 µm; 10 µm; 50 µm or 100 µm
  - **Filter Type** (Setting of the filter for the output value)
    - No filter (*default value*)
    - FIR (Finite Impulse Response Filter)
    - IIR (Infinite Impulse Response Filter)
  - **Filter Window Size** (Setting of the number of position values for calculating the filter of the output value)  
Possible values: 2...16
  - **Velocity Window Size** (Setting of the number of position values for determining the velocity of the position magnet)  
Possible values: 2...16
  - **Velocity Output Unit** (Setting the unit of the velocity output)  
Possible value: steps/1000 ms; steps/100 ms; steps/10 ms; mm/s
  - **Measuring Direction** (Setting of the measuring direction for position or velocity measurement)
    - Forward (*default value*)
    - Reverse
  - **Number of Magnets** (Setting of the number of position magnets that are used simultaneously on the sensor). If more magnets are configured than specified in the order code, a parameterization error is output. The alarm is output via alarm ID 16 (Fig. 37).
  - **Wrong Number of Magnets** (Setting of the alarm behavior when the actual number of position magnets differs from the specified number of position magnets)
    - More or less than configured
    - More than configured
    - Less than configured
    - Magnet detection alarm off (*default value*)
- The alarm is output via alarm ID 27 (Fig. 35).

Alarm ID decimal (hexadecimal)	Meaning
27 (1B)	Wrong number of magnets

Fig. 35: Alarm messages: Wrong number of magnets – MTS Profile

- **Power Supply Alarm** (Setting of the alarm behaviour when the power supply is out of the specified range).
    - Supply voltage too high or too low
    - Supply voltage too low
    - Supply voltage too high
    - Power supply alarm off (*default value*)
- The alarm is output via alarm ID 17 (Fig. 36).

Alarm ID decimal (hexadecimal)	Meaning
17 (11)	Invalid operating voltage

Fig. 36: Alarm messages: Invalid operating voltage – MTS Profile

- **Extrapolation Mode** (Setting of the sensor behaviour in case of oversampling)
  - On (The minimum cycle time of the sensor when the Extrapolation Mode is on is 250 µs, independent of the number of magnets)
  - Off (*default value*)
- **Internal Linearization** (Setup of the internal linearization)
  - Enabled (Internal linearization can only be activated if the table of internal linearization is stored on the sensor.)
  - Disabled (*default value*)

If the internal linearization is to be activated although the corresponding table is not stored on the sensor, a parameterization error is output (Fig. 37).

Alarm ID decimal (hexadecimal)	Meaning
16 (10)	Parameterization error

Fig. 37: Alarm messages: Parameterization error – MTS Profile

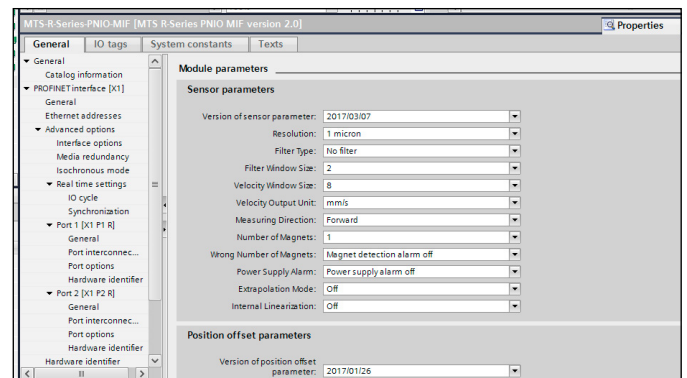

Fig. 38: Setting of the parameters

In the subsection "Position offset parameters" the offset, a shift of the lower range value, is set separately for each magnet (Fig. 39).

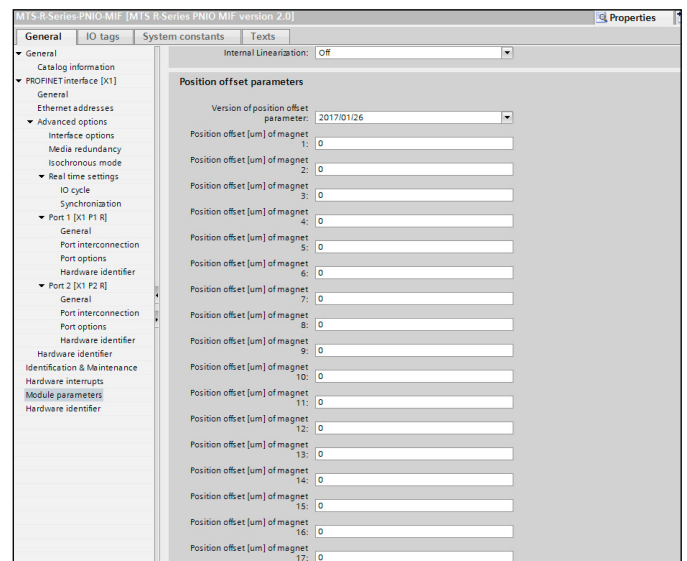

Fig. 39: Setting of the offset



In order to retrieve information from the "Input module" "Sensor status" expand the entry "PLC" in the list "Devices". Expand the entry "PLC tags" and click on "Standard-Variablen-tabelle". The window "Standard-Variablen-tabelle" opens. The status information are displayed in this window. The module "Sensor status" consists of 8 bytes:

- **Status Power supply:** 2 bytes
- **Status number of magnets:** 1 byte
- **Status bitmask:** 5 bytes

### 6.3 Parameter description for encoder profile

After you have created a project, you can include the sensor via its GSDML file. The properties and functions of a PROFINET IO field device are described in a GSDML (General Station Description) file. The XML-based GSDML file contains all relevant data that is important for both the implementation of the device in the controller and the data exchange during operation.

The GSDML file for the R-Series V PROFINET is available on our homepage [www.mtsensors.com](http://www.mtsensors.com). The GSDML file of the R-Series V PROFINET is packed into a zip file containing the data for the MTS profile and encoder profile. Download the GSDML file and save it on your computer. To include the GSDML file, select "Tools" from the menu bar of the TIA portal and click on "Manage device description file (GSD)". The "Manage device description files" window opens (Fig. 40). Enter the source path where the GSDML file of the R-Series V PROFINET with encoder profile is stored. Specify the location and press the "Install" button to install the GSDML file. The default name of the R-Series V PROFINET sensor is "MTS-R-Series-PNIO-EP". This name can be changed.

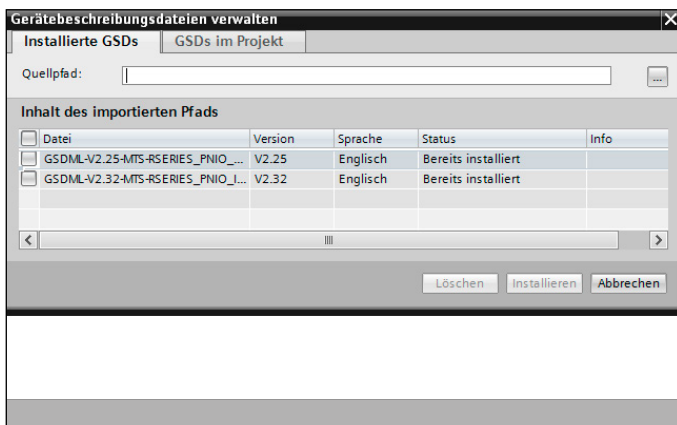

Fig. 40: View the installed GSDML files

The R-Series V PROFINET supports both RT mode and IRT mode. The sensor is set to the respective mode during connection setup with the controller. By default, the sensor operates in RT mode. To operate the sensor in IRT mode, select the tab "General" in the section "Advanced options". Select RT class "IRT" in the sub-section "Real time settings". The IRT mode prioritizes the data packets (Fig. 41).

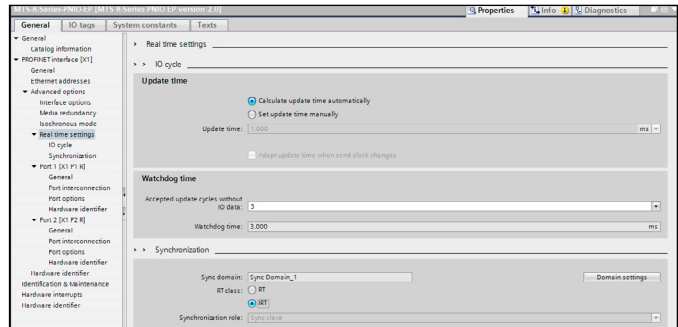

Fig. 41: Setting of the IRT-mode

To enable the control to access the sensor data isochronously, the isochronous mode must be activated in the "Advanced options" section of the "General" tab. This results in a synchronization to the transmission clock to the controller. The isochronous mode is deactivated by default (Fig. 42).

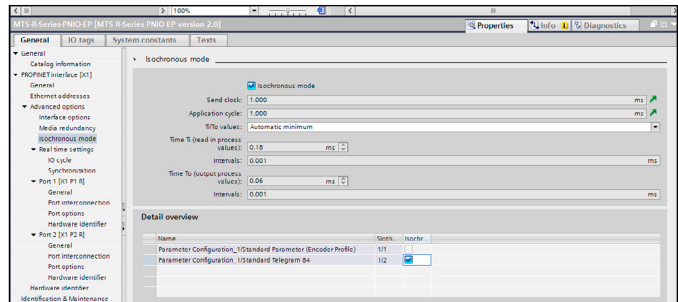

Fig. 42: Activation of the isochronous mode

Different telegrams are available for the sensor. The telegrams can be selected in the "Catalog" section. A detailed description of the telegrams is shown in Fig. 43 & Fig. 44.

Standard telegram 81																														
Standard telegram 81 uses 4 bytes for output data from the IO controller to the sensor and 12 bytes of input data from the sensor to the IO-controller.																														
Output data from the IO controller (control → sensor)																														
<b>IO Data</b>	1			2																										
<b>Byte</b>	0	1	2	3																										
<b>Actual value</b>	STW2_ENC			G1_STW																										
<b>Description</b>	Encoder control word 2			Sensor control word																										
Input data to the IO controller (sensor → control)																														
<b>IO Data</b>	1			2			3			4			5			6														
<b>Byte</b>	0	1	2	3	4	5	6	7	8	9	10	11																		
<b>Actual value</b>	ZSW2_ENC			G1_ZSW			G1_XIST1			G1_XIST2																				
<b>Description</b>	Status word 2			Status word			Position value			Position value 2																				
Standard telegram 82																														
Standard telegram 82 uses 4 bytes for output data from the IO controller to the sensor and 14 bytes of input data from the sensor to the controller.																														
Output data from the IO controller (control → sensor)																														
<b>IO Data</b>	1			2																										
<b>Byte</b>	0	1	2	3																										
<b>Actual value</b>	STW2_ENC			G1_STW																										
<b>Description</b>	Encoder Control Word 2			Sensor Control Word																										
Input data to the IO controller (sensor → control)																														
<b>IO Data</b>	1			2			3			4			5			6			7											
<b>Byte</b>	0	1	2	3	4	5	6	7	8	9	10	11	12	13																
<b>Actual value</b>	ZSW2_ENC			G1_ZSW			G1_XIST1			G1_XIST2			NIST_A																	
<b>Description</b>	Status word 2			Status word			Position value			Position value 2			Velocity																	
Standard telegram 83																														
Standard telegram 83 uses 4 bytes for output data from the controller to the sensor and 16 bytes of input data from the sensor to the controller.																														
Output data from the IO controller (control → sensor)																														
<b>IO Data</b>	1			2																										
<b>Byte</b>	0	1	2	3																										
<b>Actual value</b>	STW2_ENC			G1_STW																										
<b>Description</b>	Encoder Control Word 2			Sensor Control Word																										
Input data to the IO controller (sensor → control)																														
<b>IO Data</b>	1			2			3			4			5			6			7			8								
<b>Byte</b>	0	1	2	3	4	5	6	7	8	9	10	11	12	13	14	15														
<b>Actual value</b>	ZSW2_ENC			G1_ZSW			G1_XIST1			G1_XIST2			NIST_B																	
<b>Description</b>	Status word 2			Status word			Position value			Position value 2			Velocity																	
Standard telegram 84																														
Standard telegram 84 uses 4 bytes for output data from the controller to the sensor and 20 bytes of input data from the sensor to the controller.																														
Output data from the IO controller (control → sensor)																														
<b>IO Data</b>	1			2																										
<b>Byte</b>	0	1	2	3																										
<b>Actual value</b>	STW2_ENC			G1_STW																										
<b>Description</b>	Encoder control word 2			Sensor control word																										
Input data to the IO controller (sensor → control)																														
<b>IO Data</b>	1			2			3			4			5			6			7			8			9			10		
<b>Byte</b>	0	1	2	3	4	5	6	7	8	9	10	11	12	13	14	15	16	17	18	19										
<b>Actual value</b>	ZSW2_ENC			G1_ZSW			G1_XIST3			G1_XIST2			NIST_B																	
<b>Description</b>	Status word 2			Status word			Position value			Position value 2			Velocity																	

Fig. 43: Source: PROFIBUS Nutzerorganisation e.V.; 2008; Profile Encoder Technical Specification for PROFIBUS and PROFINET related to PROFIdrive Version 4.1

Control word 2 (STW2_ENC)			
Bit	Value	Significance	Comments
0...6	–	–	Reserved
7	$\frac{1}{0}$	Fault acknowledge (0 → 1)	The fault signal is acknowledged with a positive edge; the sensor reaction to a fault depends on the type of fault.
8, 9	–	–	Reserved
10	1	Control by PLC	Control via interface, EO IO data is valid.
	0	No control by PLC	EO IO data not valid; except sign-of-life.
11	–	–	Reserved
12...15	–	Controller sign-of-life	Supported in IRT mode
Status word 2 (ZSW2_ENC)			
Bit	Value	Significance	Comments
0...2	–	–	Reserved
3	1	Fault present	Unacknowledged faults or currently not acknowledged faults (fault messages) are present (in the buffer). The fault reaction is fault-specific and device-specific. The acknowledging of a fault may only be successful, if the fault cause has disappeared or has been removed before. If the fault has been removed the sensor returns to operation. The related fault numbers are in the fault buffer.
	0	No fault	
4...8	–	–	Reserved
9	1	Control request	The automation system is requested to assume control.
	0	No control request	Control by automation system is not possible, only possible at the device or by another interface.
10, 11	–	–	Reserved
12...15	–	Encoder sign-of-life	Supported in IRT mode
Sensor status word (G1_ZSW)			
Bit	Function	Comments	
0...7	Reference mark search, measurement on the fly	–	
8	Probe 1 deflected	–	
9	Probe 2 deflected position mode (preset)	–	
10	Reserved, set to zero	–	
11	Requirements of error acknowledgment detected	–	
12	Set/shift of home position (preset) executed	–	
13	Transmit absolute value cyclically	If bit 13 transmits absolute value cyclically or bit 15 sensor error is not set there is no valid value or error code transferred in G1_XIST2.  Bit 13 transmits absolute value cyclically cannot be set at the same time as bit 15 sensor error. These bits are used to indicate either a valid position value transmission (bit 13) or the error code transmission (bit 15) in G1_XIST2.	
14	Parking sensor active	–	
15	Sensor error	–	
Sensor control word (G1_STW)			
Bit	Function	Comments	
0...7	Reference mark search, measurement on the fly		
8...10	Reserved (without effect)		
11	Home position mode position mode (preset)		
12	Request set/shift of home position (preset)		
13	Request absolute value cyclically		
14	Activate parking sensor	If the sensor parking is activated (bit 14 = 1) the sensor is still on the bus with the slave sign-of-life active and the sensor error and diagnostics switched off.	
15	Acknowledging a sensor error		

Fig. 44: Source: PROFIBUS Nutzerorganisation e.V.; 2008; Profile Encoder Technical Specification for PROFIBUS and PROFINET related to PROFIdrive Version 4.1



The selected telegram must be dragged into the "Device Overview" window. In the example shown, telegram 84 was selected and assigned to slot 1 subslot 2 (Fig. 46).

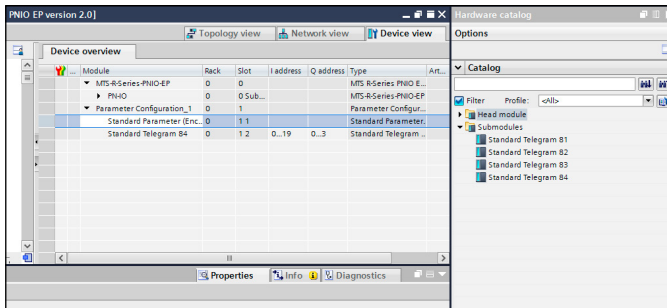

Fig. 45: Hardware Catalog

To configure the parameters, select the entry "Standard Parameters (Encoder Profile)" in the "Device Overview" window. The parameters of the R-Series V sensor can be set in the sub-section "Module Parameters" of the "General" tab (Fig. 46).

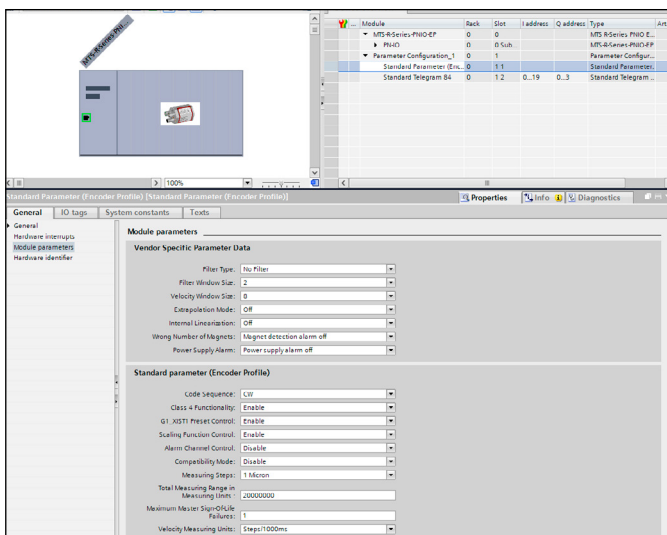

Fig. 46: Setting of the parameters

#### Vendor Specific Parameter Data:

- **Filter Type** (Setting of the filter for the output value)
  - No filter (*default value*)
  - FIR (finite impulse response filter)
  - IIR (infinite impulse response filter)
- **Filter Window Size** (Setting of the number of position values for calculating the filter of the output value)  
Possible values: 2...16 (*default value* = 2)
- **Velocity Window Size** (Setting of the number of position values for determining the velocity of the position magnet)  
Possible values: 2...16 (*default value* = 8)
- **Extrapolation Mode** (Setting of the sensor behaviour in case of oversampling)
  - On (The minimum cycle time of the sensor when the Extrapolation Mode is on is 250 µs, independent of the number of magnets)
  - Off (*default value*)

- **Internal Linearization** (Setting of the internal linearization)
  - On (Internal linearization can only be activated if the table of internal linearization is stored on the sensor)
  - Off (*default value*)
- **Wrong Number of Magnets** (Setting of the alarm behaviour when the actual number of position magnets differs from the specified number of position magnets)
  - More or less than one magnet
  - More than one magnet
  - Less than one magnet
  - Magnet detection alarm off (*default value*)
- **Power Supply Alarm** (Setting of the alarm behaviour when the power supply is out of the specified range)
  - Supply voltage too high or too low
  - Supply voltage too low
  - Supply voltage too high
  - Power supply alarm off (*default value*)

These diagnostic outputs are implemented via alarm messages and the PROFINET interface. The R-Series V PROFINET sensors support the following diagnostic messages:

Alarm ID		Meaning
decimal	hexadecimal	
36865	9001	High operating voltage
36866	9002	Low operating voltage
36874	900A	Wrong number of magnets

Fig. 47: Alarm messages – Encoder Profile

In addition to the manufacturer-specific parameters, there are the following standard parameters according to the encoder profile:

- **Code sequence:**  
Specifies the measurement direction for position measurement
  - CW (clockwise) = forward (values increasing from sensor electronics housing to rod end/profile end) (*default value*)
  - CCW (counter clockwise) = reverse (values decreasing from sensor electronics housing to rod end/profile end)
- **Class 4 functionality:**  
Activating/deactivating the following parameters: Code sequence, scaling function, measuring step, total measuring range, velocity unit and G1\_XIST1 preset control. With "Class 4 functionality" de-activated, the sensor measures with a resolution of 1 µm. Any configured "Preset" is not taken into account and the measuring direction is forward. If the parameter "G1\_XIST1 preset control" is activated this will affect G1\_XIST1, G1\_XIST2 and G1\_XIST3.
- **G1\_XIST1 preset control (preset affects XIST1):**  
Specifies the effect of a preset on G1\_XIST1. This parameter is without function if the parameter Class 4 functionality is deactivated. If Class 4 functionality is activated and G1\_XIST1 preset control is disabled, the position value in G1\_XIST1 will not be affected by a preset. Should be selected, if the preset should have an impact not only on G1\_XIST2 and G1\_XIST3, but also on G1\_XIST1.

• **Scaling function control:**

Activating/deactivating the scaling function. The “Scaling function”- parameter can be used to change the encoder resolution. Note that the “Scaling function” parameters can be activated only, if “Class 4 functionality” and “Scaling function control” are activated. Otherwise, the scaling function is disabled and the resolution is 1 µm.

• **Alarm channel control:**

Activating/deactivating the alarm channel. This parameter is used to limit the amount of data sent. This parameter is only supported in compatibility mode and can be deactivated only in compatibility mode V3.1.

• **Compatibility mode V3.1:**

Activating/deactivating the compatibility mode. This parameter indicates, if the sensor should run in a mode compatible with encoder profile 3.1. The functions which are affected when this parameter is activated are listed in Fig. 50.

• **Measurement step:**

Position measurement resolution 0.5, 1 (*default value*), 2, 5, 10, 50, 100 µm, provided that the “Scaling function” is activated.

• **Measurement range:**

Limits the measuring range to the number of measurement steps, provided that the “Scaling function” is activated.

• **Maximum master sign-of-life failures:**

Specifies the number of allowed failures of the masters sign-of-life. This parameter is only supported in compatibility mode V3.1. If the maximum number of permissible errors is exceeded, the position sensor sends a sign of life error in G1\_XIST2.

• **Velocity unit <sup>3</sup>:**

Specifies the coding of the velocity units used to configure the signals NIST\_A and NIST\_B (Fig. 48).

Velocity measuring units	Value
Steps/s	0
Steps/100 ms	1
Steps/10 ms	2

Fig. 48: Velocity units

Attribute	Meaning	Value
Enable	Compatibility with encoder profile V3.1	0
Disable	No backward compatibility (default)	1

Fig. 49: Compatibility mode

Function	Compatibility mode enabled (= 0)	Compatibility mode disabled (= 1)
Control by PLC (STW2_ENC)	Ignored, the control word (G1_STW) and the set point values are always valid. Control requested (ZSW2_ENC) is not supported and is set to 0.	Supported
User parameter Maximum Master Sign-Of-Life-failures	Supported	Not supported. A sign-of-life counter error is tolerated. Parameter 925 is optional for sign-of-life monitoring control.
User parameter alarm channel control	Supported	Not supported, the application alarm channel is active and controlled by a PROFIdrive parameter.
P965 Profile Version	31 (V3.1)	41 (V4.1)

Fig. 50: Function

3/ A “step” corresponds to the selected resolution

## 7. Programming and Configuration via SIMOTION SCOUT

This instruction describes exemplarily the project engineering of a Siemens SIMATIC STEP 7 for the integration and programming of a Temposonics® R-Series V sensor with PROFINET. The engineering software Siemens SIMOTION SCOUT V5.1 and the controller Siemens SIMOTION P320-4 are used. The operation may differ for controllers and software of other versions and manufacturers.

### NOTICE

Follow the information given in the controller manual.

### 7.1 Creating and configuring a project

1. Create a new project in the Siemens SIMOTION SCOUT software by clicking "New..." in the upper menu bar under "Project".

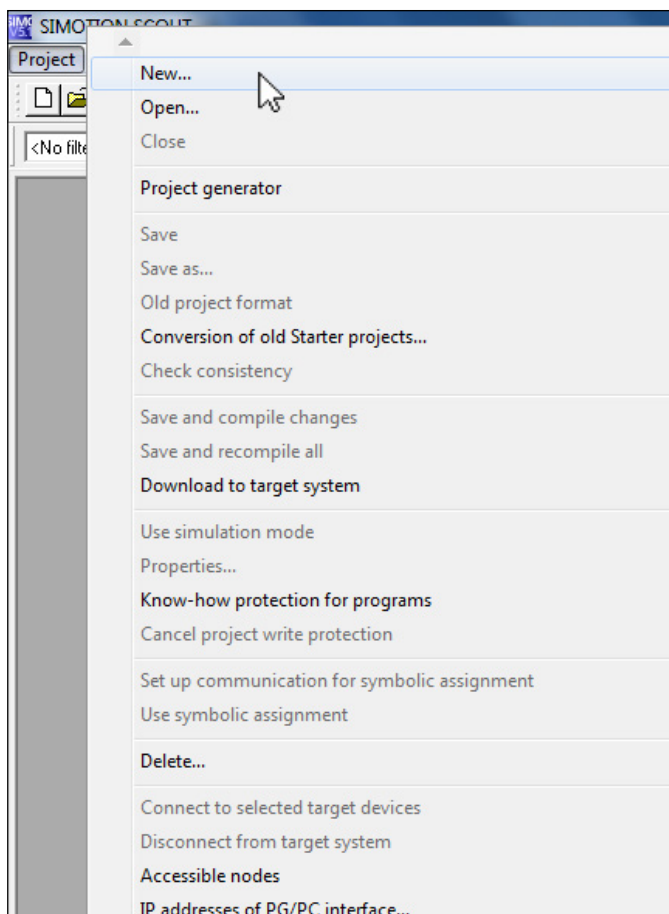

Fig. 51: Creating a new project

2. The window "New Project" opens, in which the name of the new project must be entered. In this example the name "R5\_Profinet\_IRT\_U402" is selected. Confirm your entry by pressing the "OK" button.

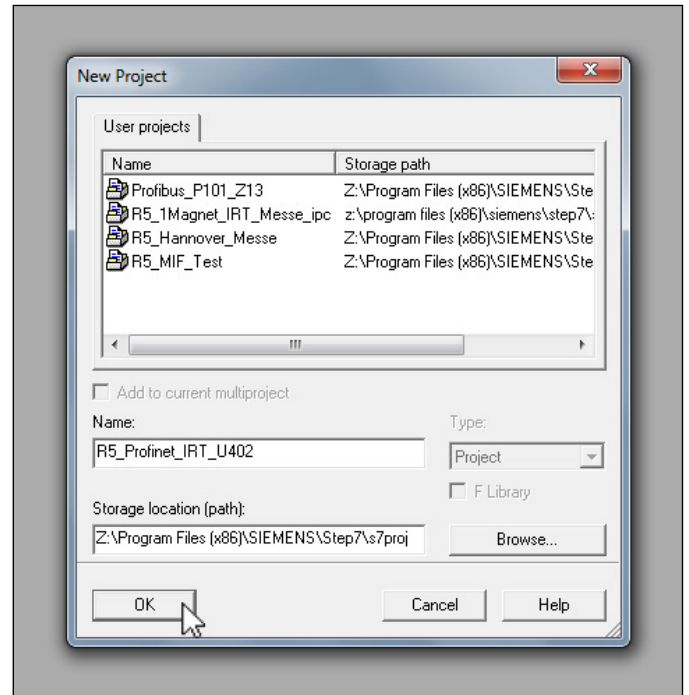

Fig. 52: Creating a new project

3. Insert the controller into the application. In this example, the Siemens SIMOTION P320-4 device is added. To do this, select the entry "Insert SIMOTION device" in the project bar on the left with a double click. The "Insert SIMOTION device" window opens. In this example, the device version "P320-4 PN" is selected. Confirm the selection by clicking "OK".

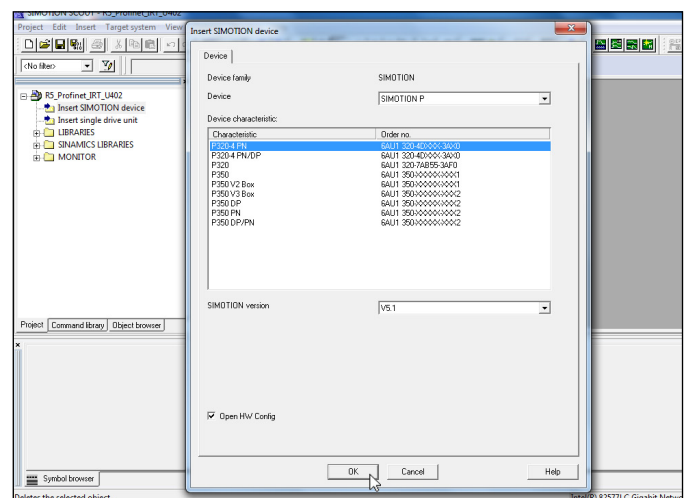

Fig. 53: Inserting a SIMOTION device



## 7.2 Integrating the GSDML file

The properties and functions of a PROFINET IO field device are described in a GSDML file (General Station Description). The XML-based GSDML file contains all relevant data that is important both for the implementing the device in the controller and for data exchange during operation.

The GSDML file of the R-Series V PROFINET is available on the homepage [www.mtsensors.com](http://www.mtsensors.com). The GSDML file of the R-Series V PROFINET is packed into a zip file containing the data for the MTS profile and encoder profile. Download the GSDML file and save it on your computer.

1. Click in the upper menu bar of the hardware configurator under "Options" the entry "Install GSD File..."

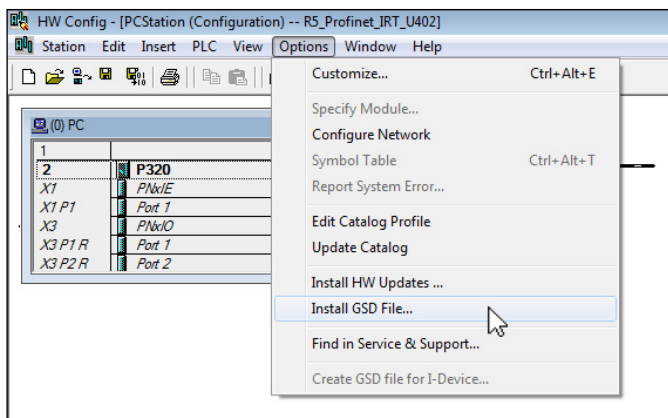

Fig. 58: Starting the installation of the GSDML file

2. In the window that opens, specify the location where the GSDML file of the R-Series V PROFINET is stored. All GSDML files in the selected folder are displayed. Select the GSDML file of the R-Series V PROFINET from the list and start the installation of the GSDML file by clicking the "Install" button.

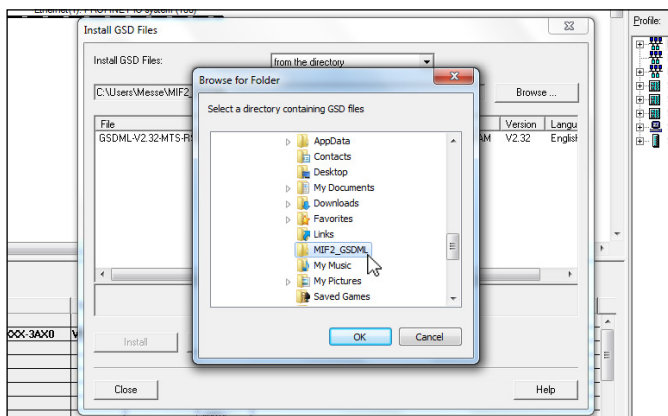

Fig. 59: Selection of the GSDML file for installation

3. After successful installation of the GSDML file, the window shown opens. Confirm the successful installation by clicking the "OK" button.

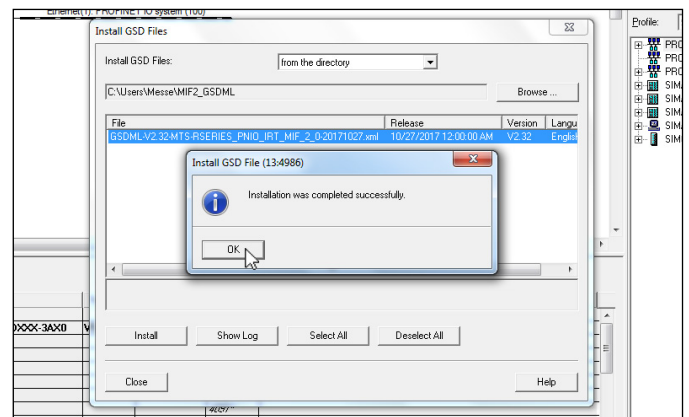

Fig. 60: Successful installation of the GSDML file

## 7.3 Integration and configuration of the sensor with MTS profile

The following instruction describes the integration and configuration of the R-Series V PROFINET with MTS profile.

1. In the menu bar "Catalog" on the right of the hardware configurator the PROFINET devices are listed. Expand the entries "PROFINET IO" → "Additional Field Devices" → "Encoders" → "Temposonics position sensors". Select the R-Series V with the name "MTS R-Series PNIO MIF version 2.0".

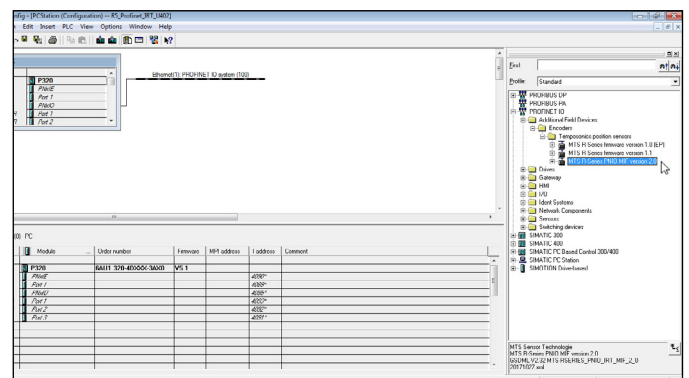

Fig. 61: Selecting the R-Series V PROFINET in the catalog of the hardware configurator

2. Drag the entry of the R-Series V from the "Catalog" into the main window and pin it to the PROFINET network. The R-Series V icon is displayed on the network. If the R-Series V icon on the network is marked, it will be listed in the address list at the bottom of the hardware configurator. In this example, the sensor is assigned to slot 0.

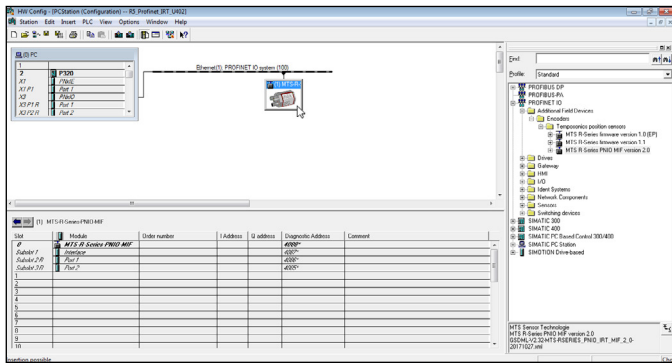

Fig. 62: R-Series V PROFINET with the name MTS-R-Series-PNIO-MIF in the address list of the hardware configurator

3. Various input modules are available for the R-Series V PROFINET with MTS profile. Expand the entry "Input moduls" below the sensor "MTS R-Series PNIO MIF version 2.0" in the catalog on the right. The following input modules are available:

- **All positions:** This module contains the positions of up to 30 magnets. The number of magnets shown in this module depends on the number of magnets specified in the parameter "Number of Magnets". With this module, 160 bytes are always transferred. Each magnet is assigned 4 bytes for the position value (1st magnet: 0...3 bytes, 2nd magnet: 4...7, etc.). If less than 30 magnets are operated on the sensor, the unused bytes are written with "0".
- **All velocities:** This module contains the velocity of up to 30 magnets. The number of magnets shown in this module depends on the number of magnets specified in the parameter "Number of Magnets". With this module, 160 bytes are always transferred. Each magnet is assigned 4 bytes for the velocity value (1st magnet: 0...3 bytes, 2nd magnet: 4...7, etc.). If less than 30 magnets are operated on the sensor, the unused bytes are written with "0".
- **Position:** This module contains the position of a magnet. Afterwards you must assign a magnet to this module.
- **Position and velocity:** This module contains the position and velocity of a magnet. This module transfers 8 bytes. The bytes 0...3 contain the position value and the bytes 4...7 contain the velocity value of the selected magnet. Afterwards you must assign a magnet to this module.

- **Sensor status:** This module shows the current status of the sensor:
  - Current power supply in mV
  - Number of magnets on the sensor rod
  - Bit mask for indicating which magnet number is detected on the sensor
- **Velocity:** This module contains the velocity of a magnet. Afterwards you must assign a magnet to this module.

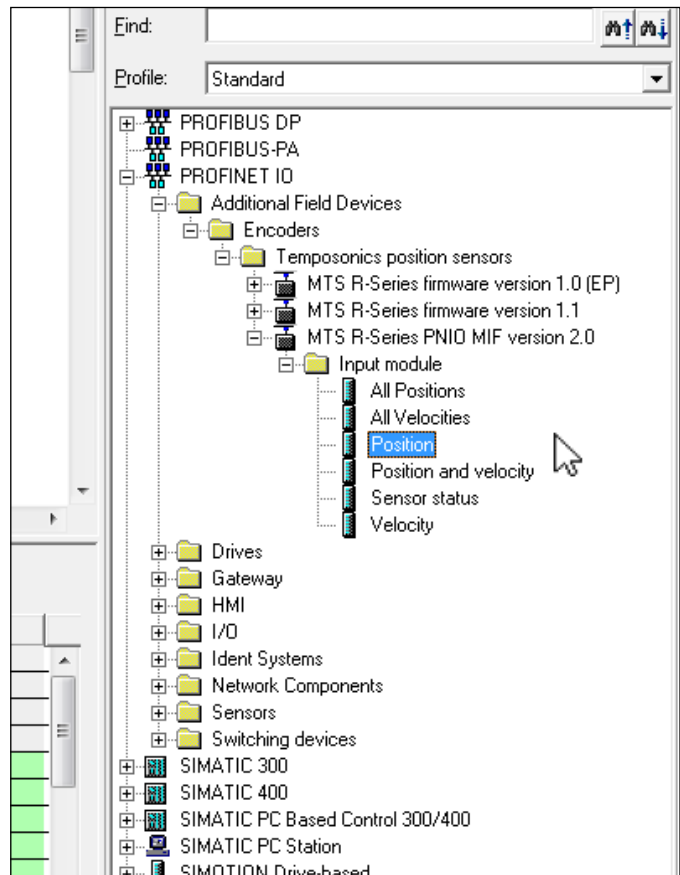

Fig. 63: Input modules of the R-Series V PROFINET with MTS profile in the catalog of the hardware configurator



A double click on the selected module adds it to the sensor in the address list. The selected module can also be dragged and dropped into a free slot of the address list. In this example, the "Position" module is selected and added to the address list. The address is assigned automatically.

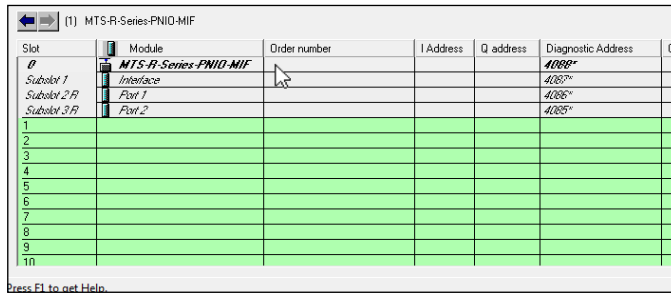

Fig. 64: Input module "Position" in the address list of the hardware configurator

While the "All positions" and "All velocities" modules contain up to 30 magnets, the "Position", "Velocity" and "Position and velocity" modules contain the values of only one magnet at a time. Therefore, a magnet must be assigned to these modules. This assignment is carried out by double-clicking on the module in the address list. After a double click, the "Properties - Position" window opens to display the properties of the input module "Position". In the "Parameters" tab a magnet can be assigned to the selected module.

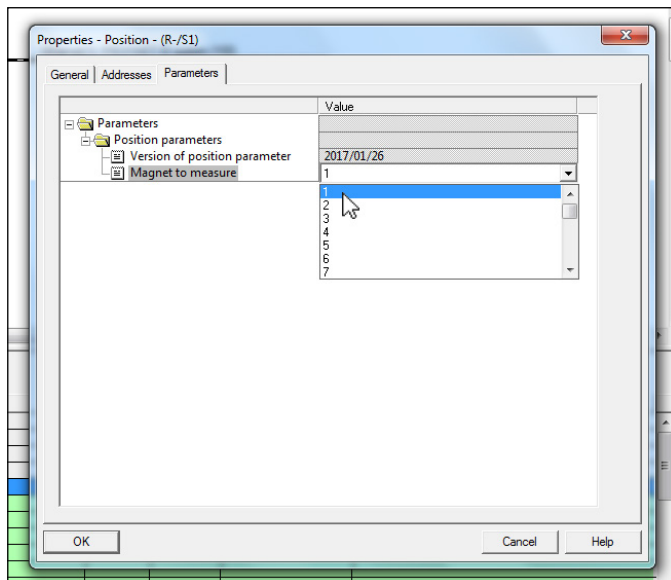

Fig. 65: Assignment of the magnet to the selected input module „Position“

4. To view and configure the parameters of the sensor, double-click on the "MTS-R Series-PNIO-MIF" module in slot 0 of the address list. In the opening window "Properties - MTS-R-Series-PNIO-MIF" select the tab "Parameters". Set the parameters according to your application.

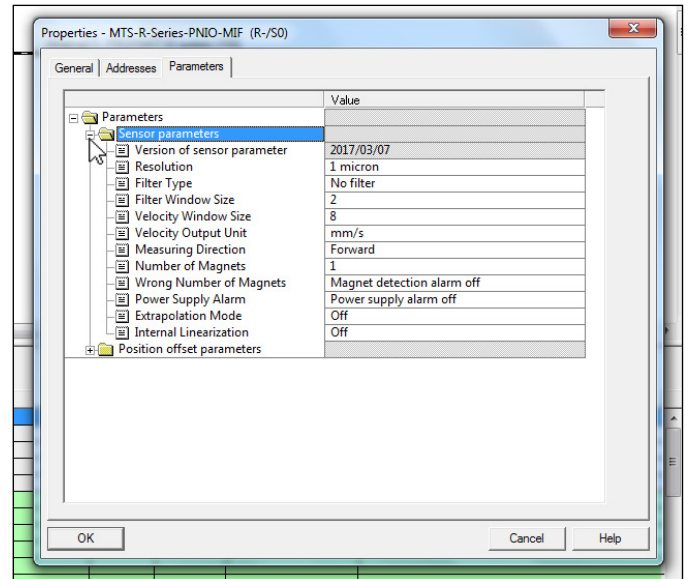

Fig. 66: Setting of the parameters of the R-Series V PROFINET with MTS profile

The following parameters can be adjusted:

- **Resolution** (Setting of the resolution for position measurement)  
Possible values: 0.5 µm; 1 µm; 2 µm; 5 µm; 10 µm; 50 µm or 100 µm
  - **Filter Type** (Setting of the filter of the output value)
    - No Filter (*default value*)
    - FIR (finite impulse response filter)
    - IIR (infinite impulse response filter)
  - **Filter Window Size** (Setting of the number of position values for calculating the filter of the output value)  
Possible values: 2... 16
  - **Velocity Window Size** (Setting of the number of position values for determining the velocity of the position magnet)  
Possible values: 2... 16
  - **Velocity Output Unit** (Setting the unit of the velocity output)  
Possible values: steps/1000 ms; steps/100 ms; steps/10 ms; mm/s
  - **Measuring Direction** (Setting of the measuring direction for position or velocity measurement)
    - Forward (*default value*)
    - Reverse
  - **Number of Magnets** (Setting of the number of position magnets that are used simultaneously on the sensor). If more magnets are configured than specified in the order code, a parameterization error is output. The alarm is output via alarm ID 16 (Fig. 67).
  - **Wrong Number of Magnets** (Setting of the alarm behavior when the actual number of position magnets differs from the specified number of position magnets)
    - More or less than configured
    - More than configured
    - Less than configured
    - Magnet detection alarm off (*default value*)
- The alarm is output via alarm ID 27 (Fig. 67).

- **Power Supply Alarm** (Setting of the alarm behavior when the power supply is out of the specified range)
  - Supply voltage too high or too low
  - Supply voltage too low
  - Supply voltage too high
  - Power supply alarm off (do not send alarm) (*default value*)

The alarm is output via alarm ID 17 (Fig. 67).

- **Extrapolation Mode** (Setting of the sensor behavior in case of oversampling)
  - On (The minimum cycle time of the sensor when the Extrapolation Mode is on is 250 µs, independent of the number of magnets)
  - Off (*default value*)
- **Internal Linearization** (Setting of the internal linearization)
  - On (Internal linearization can only be activated if the table of the internal linearization is stored on the sensor)
  - Off (*default value*)

If the internal linearization is to be activated although the corresponding table is not stored on the sensor, a parameterization error is output. The alarm is output via alarm ID 16 (Fig. 67).

- **Position offset parameters:** Shift of the lower range value, separately for each magnet.

Alarm ID		Meaning
decimal	hexadecimal	
27	1B	Wrong number of magnets
17	11	Invalid operating voltage
16	10	Parameterization error

Fig. 67: Alarm messages - MTS Profile

## 7.4 Configuration of the sensor in the network

1. To be able to configure the network settings of the sensor, mark the symbol of the R-Series V PROFINET on the network. Click in the upper menu bar on the entry "PLC". Then select the entry "Edit Ethernet Node" under "Ethernet".

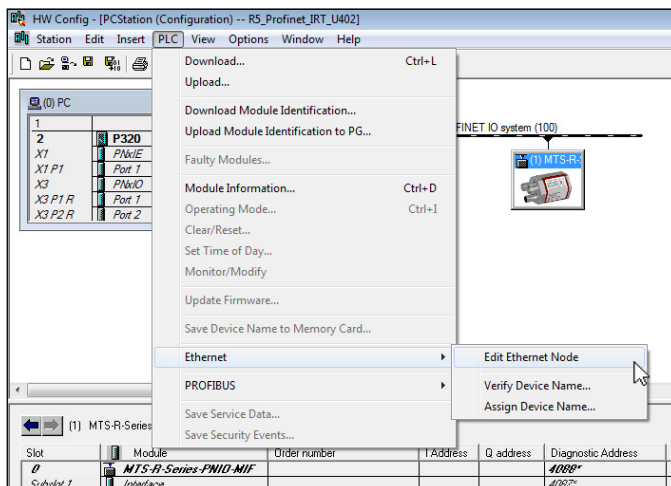

Fig. 68: Starting the network configuration of the sensor

2. In the opening window "Edit Ethernet Node" you can search for the sensor via the button "Browse...".

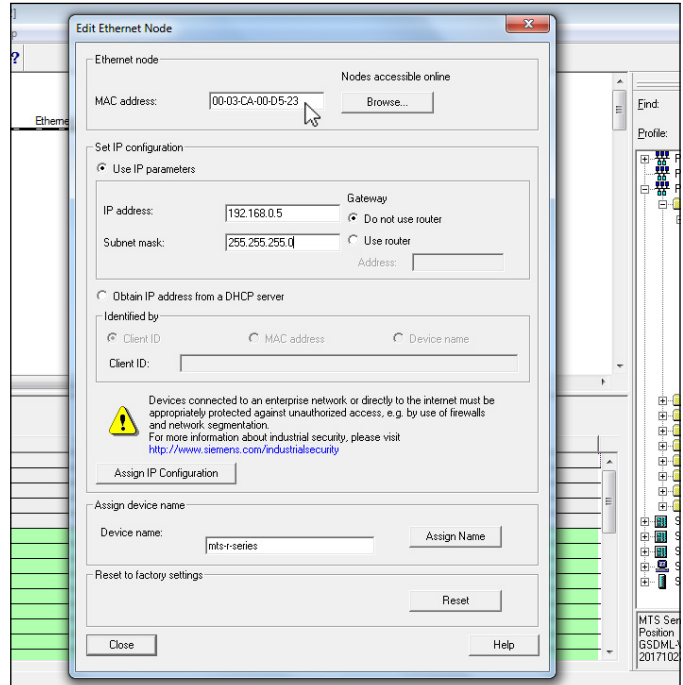

Fig. 69: Searching for devices in the network for configuration

3. All devices in the network are listed. Select the R-Series V PROFINET sensor to be configured from the list. The LED for sensor identification is activated via the "Flash" button. The identification LED on the selected sensor flashes. In this example the sensor "MTS R-Series PNIO MIF version 2.0" is selected. In this list of available devices, the control in the network is also displayed.

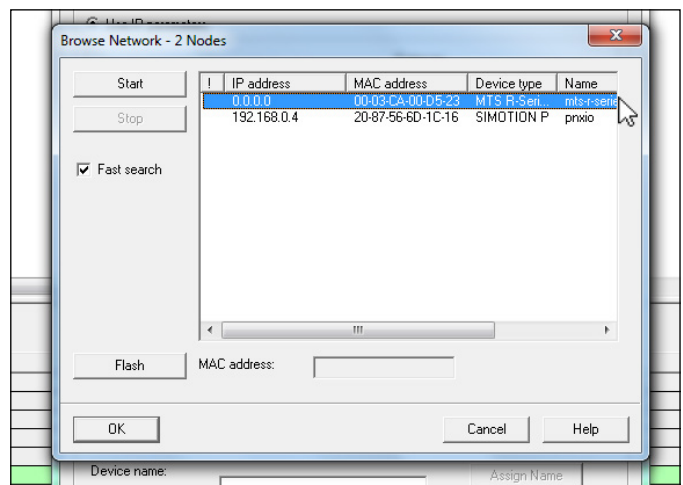

Fig. 70: Selection of the device to be configured



4. The MAC address of the sensor is displayed in the "Edit Ethernet Node" window. Enter the IP address and the subnet mask according to your network. Then click the "Assign IP Configuration" button to perform the configuration.

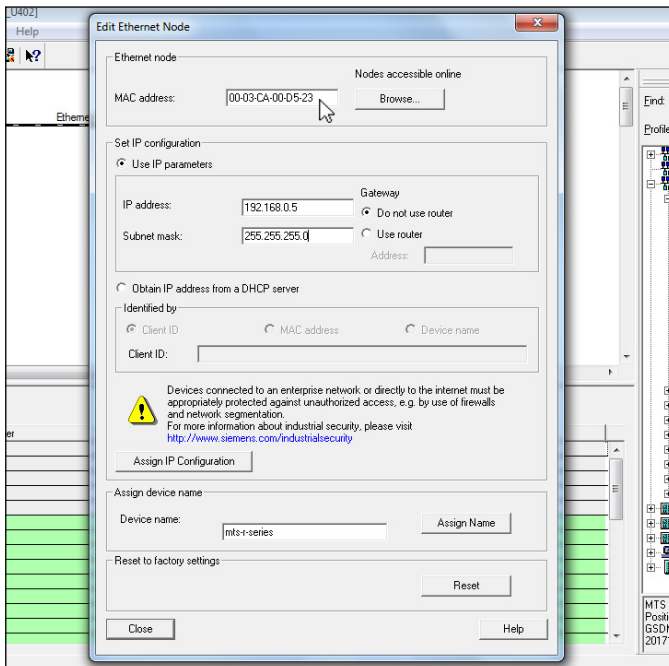

Fig. 71: Network configuration of the selected sensor

5. The successful execution of the configuration is shown in the following window. Confirm this by clicking the "OK" button.

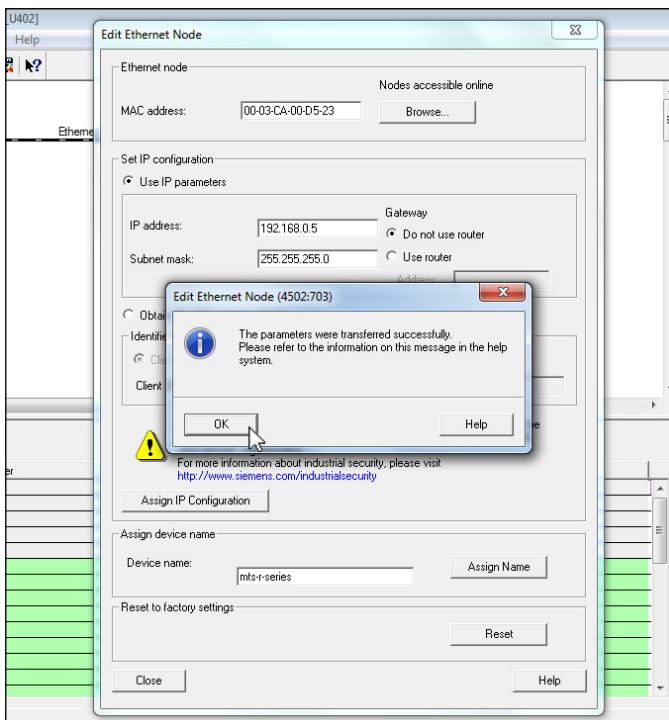

Fig. 72: Successful execution of the network configuration of the sensor

6. Assign the name of the device in the window "Edit Ethernet Node" by an entry in the field "Device name". In this example the sensor has the name "MTS-R-Series-PNIO-MIF". Then click the button "Assign Name". The successful execution of the name assignment is shown in the following window. Confirm this by clicking the "OK" button.

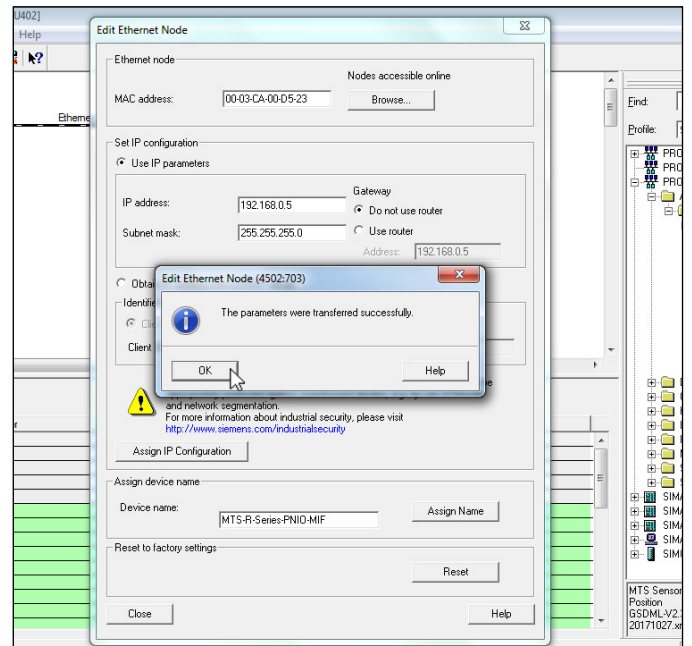

Fig. 73: Successful execution of the name assignment of the sensor

7. To check the assignment of the name, click on "PLC" in the upper menu bar. Then select the entry "Verify Device Name" under "Ethernet".
8. The successful check of the name assignment is confirmed in the following window. Close the window by clicking the "Close" button.

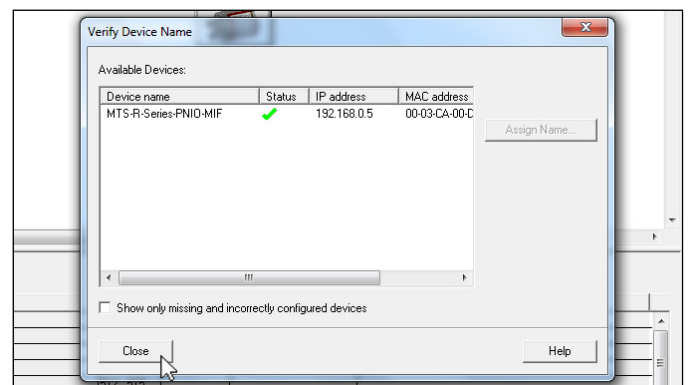

Fig. 74: Successful check of the name assignment

## 7.5 Enable RT mode and IRT mode

The R-Series V PROFINET supports both RT mode and IRT mode. The sensor is set to the respective mode during the connection setup with the controller. The following steps describe how to activate the IRT mode on the controller.

1. The sensor is informed when the connection is established that the IRT mode is activated. To do this, set the port, to which the sensor is connected, to the isochronous mode. Select the R-Series V icon on the network, so that the sensor is displayed in the address list at the bottom of the hardware configurator. Double-click on the "Subslot 1" in the address list to open the "Properties – Interface (Subslot 1)" window. In the window select the tab "Synchronization" and set the parameter "Synchronization role" to the value "Sync slave". The value the "RT Class" is set to the value "IRT". Confirm it by clicking the "OK" button.

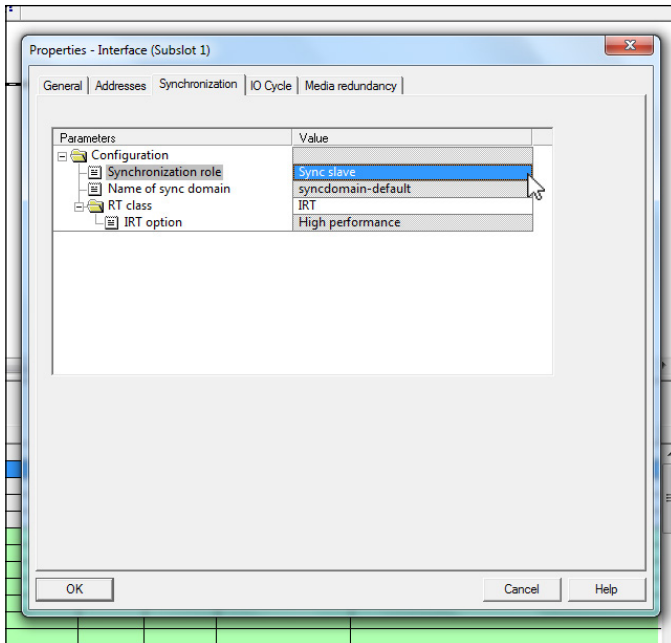

Fig. 75: Setting the sensor via the control to the IRT mode as "Sync slave"

2. Double-click on "Subslot 2 R" in the address list to open the "Properties - Interface - Port 1 (Subslot 2 R)" window. In the "Topology" tab, assign the port of the sensor to the controller. In this example, port 1 of the sensor is assigned to the controller. Confirm the entry by clicking the "OK" button.

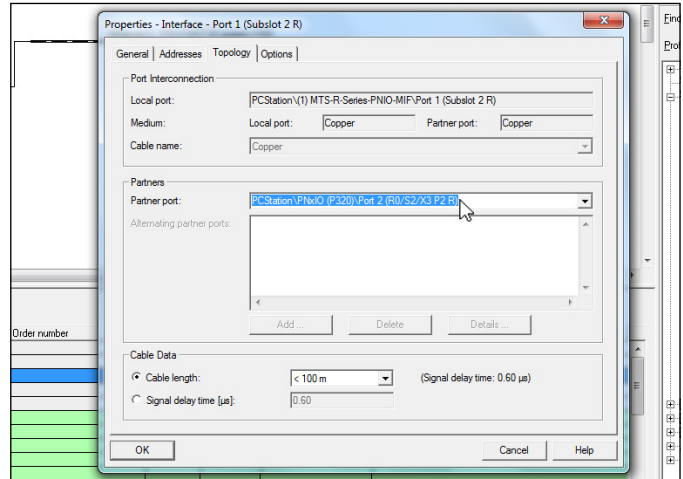

Fig. 76: Assignment of port 1 of the sensor to the controller

3. In this example, port 2 of the sensor is not connected to another component. Therefore the entry "Any partner" is selected in the "Topology" tab under "Partner port".

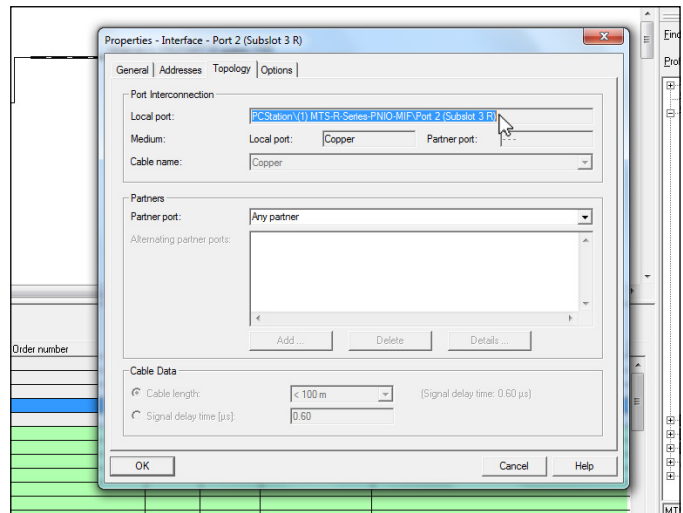

Fig. 77: Port 2 of the sensor is not assigned to any device

4. To operate the sensor and controller in IRT mode, select at the controller the isochronous mode. Double-click on the "P320" controller in the controller icon "(0) PC" in the main window. As described in chapter 7.1, the control "P320" is used in this example. The window with the properties of the controller "Properties - P320" opens. In the "Isochronous Tasks" tab, activate the entry "PNxIO (X3): Use I/O data isochronously to the Servo". Confirm the entry by clicking the "OK" button.

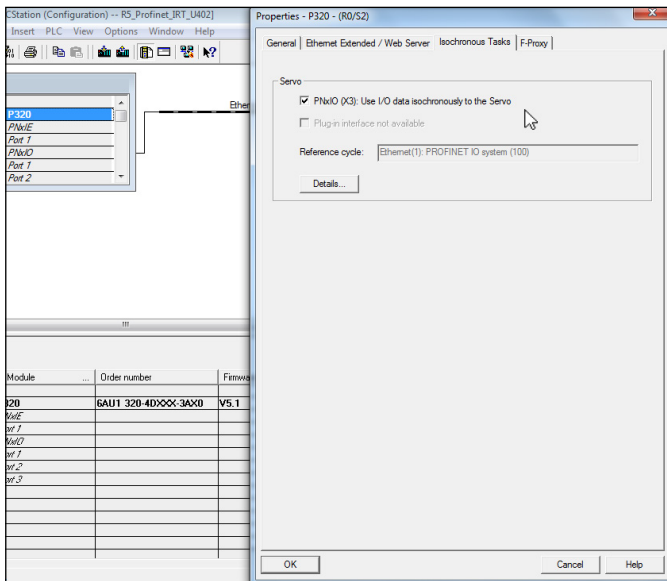

Fig. 78: Assignment of port 1 of the sensor to the controller

5. In Fig. 75 the sensor was set as "Sync slave" via the control in IRT mode. Make the setting on the controller in the same way. Activate the isochronous mode on your controller. Fig. 79 shows this for the interface X3 – PNxIO. By a double-click on the interface in the icon of the controller "(0) PC" in the main window, the "Properties - PNxIO" window opens. Set in the tab "Synchronization" under the entry "Configuration" the parameter "Synchronization role" to the value "Sync master". Confirm the entry by clicking the "OK" button.

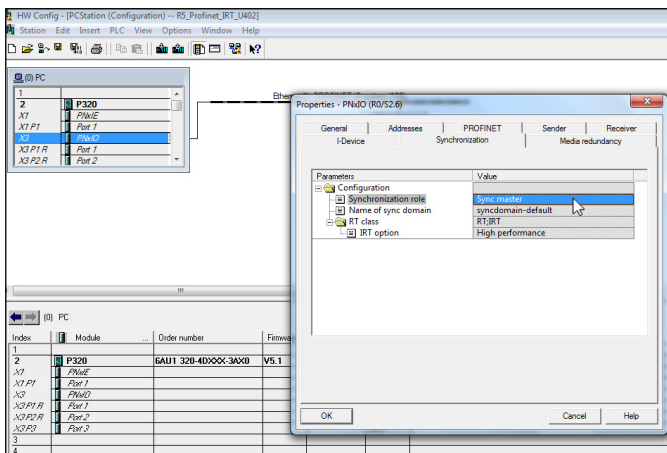

Fig. 79: Setting the controller for IRT mode as "Sync master"

6. To set the cycle time with which the controller (Sync master) polls the sensor (Sync slave), click with the right mouse button on the network. A menu opens. Select the entry "PROFINET IO Domain Management...".

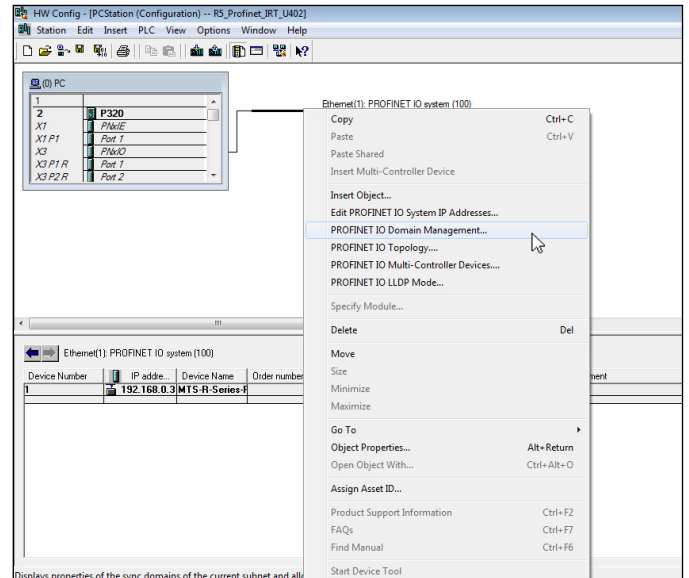

Fig. 80: Starting the "PROFINET IO Domain Management"

7. The window "Domain management - Ethernet" opens. In the "Sync Domain" tab under "Send clock time", set the cycle time with which the position or velocity values are requested from the sensor. Note the measurement cycle time of the sensor. If a polling cycle time is selected that is shorter than the measuring cycle time of the sensor, activate the "Extrapolation Mode" parameter for the sensor (see Fig. 66 for setting the parameters). Confirm the entry by clicking the "OK" button.

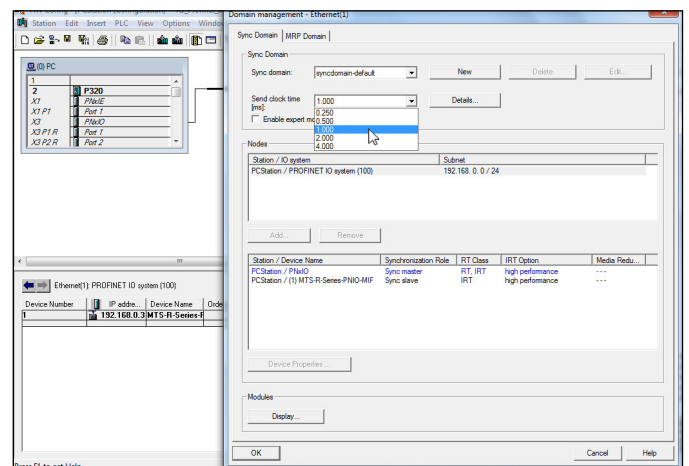

Fig. 81: Setting the cycle time in IRT-Modus

8. To adjust the connection of the sensor for the IRT mode, double-click in the address list on the "Interface" module in "Subslot 0". The window "Properties - Interface (Subslot 1)" opens. In the "IO Cycle" tab, select the "Servo" entry in the "Assign IO device in isochronous mode" field. Thus the "Servo" is defined as the IO device for the isochronous mode for the connection in the same way as for the control.

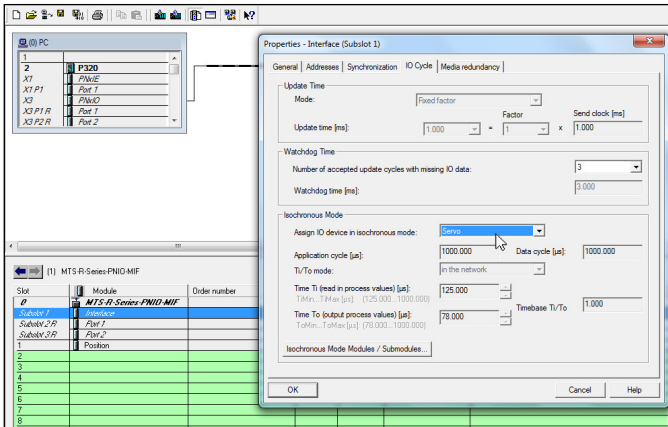

Fig. 82: Adjustment of the sensor via the control for the IRT mode

## 7.6 Downloading the program to the controller

1. In order to load the station onto the controller, it must be consistent. Check the consistency by selecting "Consistency Check" in the upper menu bar under "Station". The check is started.

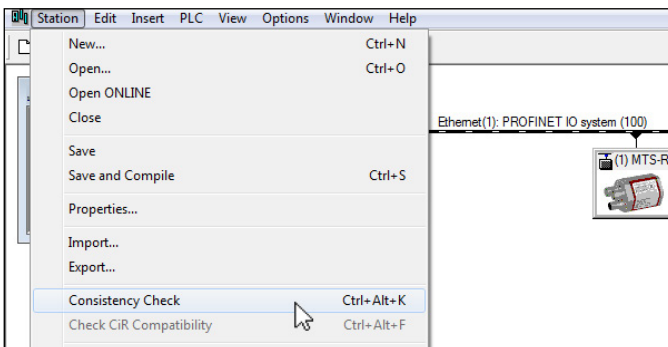

Fig. 83: Performing the consistency check

2. The results of the consistency check are then displayed. Close the window by clicking the "Close" button.

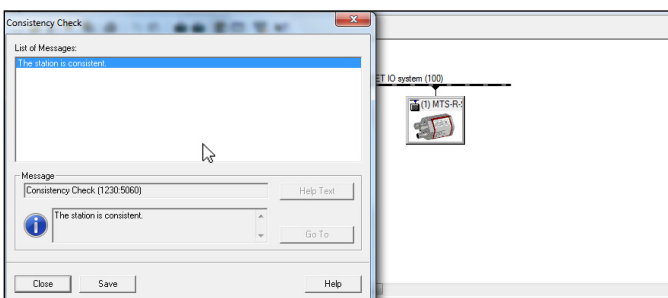

Fig. 84: Results of the consistency check

3. Save and compile the created program by clicking the "Save and Compile" button in the menu bar.

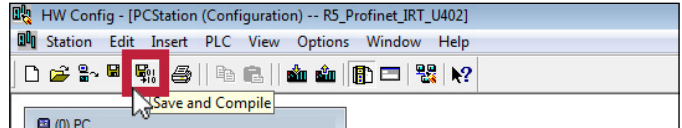

Fig. 85: Saving and compiling the project

4. After successful compilation, download the program to the controller by clicking the "Download to Module" button.

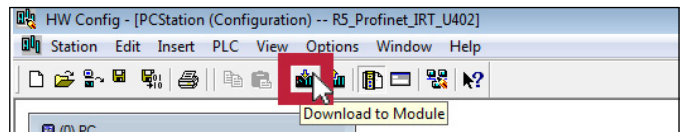

Fig. 86: Downloading the program

5. The "Select Node Address" window opens. Click on "View" to display which address is set on the controller. If necessary, adjust the address in the "IP address" field. Confirm with "OK".

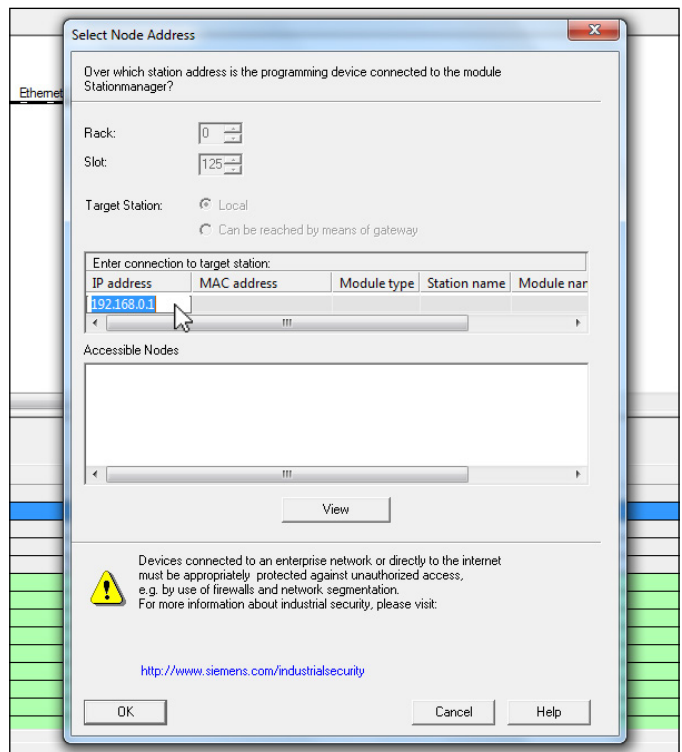

Fig. 87: Selecting the node address for downloading the program

### 7.7 Creating a program for recording the raw Position Values

1. Open the software configurator of the Siemens SIMOTION.  
Double-click on the "ADDRESS LIST" entry in the menu on the left to open the address list at the bottom of the screen. In the view "I/Os" the input and output modules of the created program are listed. In this example, an input module with the name "Positionbytes" is created.

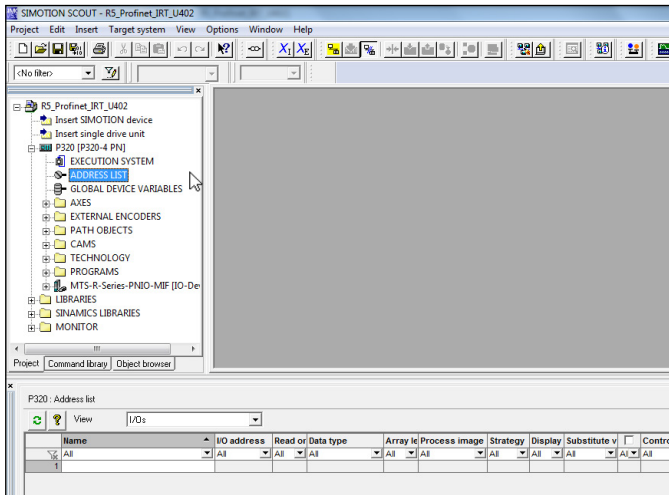

Fig. 88: Creating an input module in the address list of the software configurator

2. Enter the start address for the created module in the "I/O address" column and the number of bytes in "array length" column. In this example, the start address "512" and an array length of 4 bytes are assigned to the module. Select the I/O address according to the entry in the hardware manager: in Fig. 64 the module "Position" was added to the address list of the hardware configurator and the address 512...515 was assigned. The length of the array is then created.

Name	I/O address	Read or Data type	Array length	Process image	Strategy	Display	Substit...
All	All	All	All	All	All	All	All
Positionbytes	PIB 512	ARRAY OF BYTE	4		Substitu...		
Positionbytes[0]	PIB 512	BYTE	1		Substitu...	HEX	
Positionbytes[1]	PIB 513	BYTE	1		Substitu...	HEX	
Positionbytes[2]	PIB 514	BYTE	1		Substitu...	HEX	
Positionbytes[3]	PIB 515	BYTE	1		Substitu...	HEX	

Fig. 89: Setting the start address and the array length for the input module

3. Save and compile the created project by clicking the "Save project and compile changes" button in the menu bar.

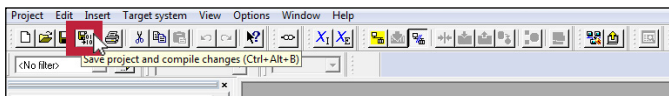

Fig. 90: Saving and compiling the project

4. To download the project to the controller, first press the "Connect to selected target devices" button.

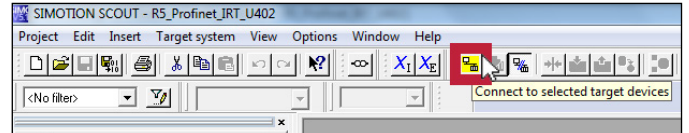

Fig. 91: Connecting with target device to download the project

5. Then click the "Download project to target system" button.

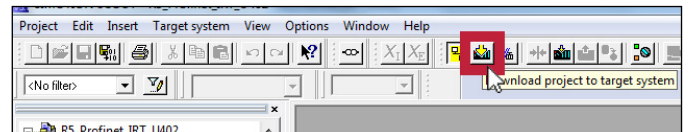

Fig. 92: Downloading the project to the target system

The "Download to target system" window opens. Confirm the entries by clicking the "Yes" button.

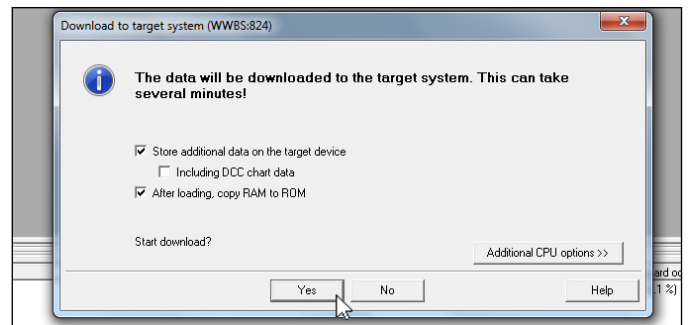

Fig. 93: Starting the process to download the project to the target system

6. After successful download to the controller, the raw position value of the position magnet is displayed in the address list in the column "Status value". In this example, the raw position value is displayed as a hexadecimal number in 4 bytes.

Name	I/O address	Read or Data type	Array length	Process image	Strategy	Display	Substit...	Status value	Control value	Availability
All	All	All	All	All	All	All	All	All	All	All
Positionbytes	PIB 512	ARRAY OF BYTE	4		Substitu...					
Positionbytes[0]	PIB 512	BYTE	1		Substitu...	HEX	16800	16800		10: No error signaled
Positionbytes[1]	PIB 513	BYTE	1		Substitu...	HEX	16800	16800		10: No error signaled
Positionbytes[2]	PIB 514	BYTE	1		Substitu...	HEX	16800	16800		10: No error signaled
Positionbytes[3]	PIB 515	BYTE	1		Substitu...	HEX	16800	16800		10: No error signaled

Fig. 94: Displaying the position raw values in the address list



## 7.8 Creating a program for evaluating the raw position data

1. To display the raw position data as a decimal value, a ST program is created. To create an ST program, click the "Insert ST source file" in the menu on the left of the software configurator. A corresponding window opens. In this example, the program is given the name "ST\_1". Confirm the entry by clicking "OK" button.

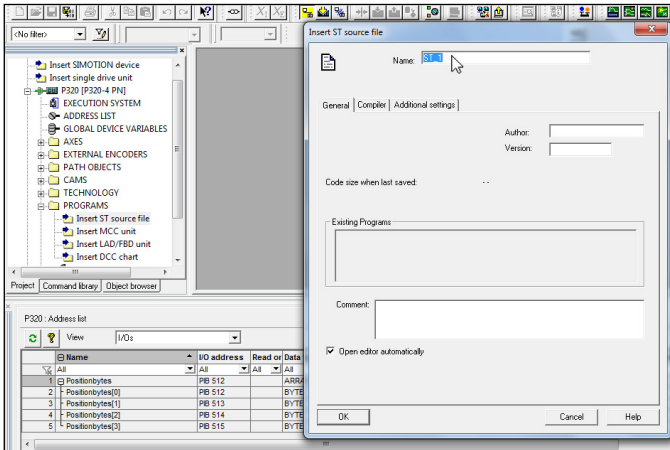

Fig. 95: Connecting with target device to download the project

2. The following figure shows an example program with the name "PositionCalculate" for the conversion of raw position data into decimal values.

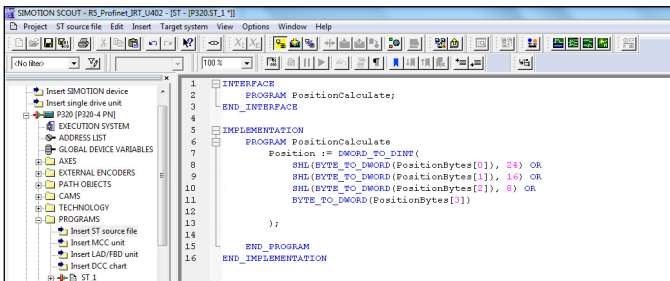

Fig. 96: Example program for converting the position raw data

3. Double-click on "GLOBAL DEVICE VARIABLES" in the menu on the left of the software configurator. The window for the global device variables opens at the bottom of the software configurator. Select "DEC" in the display format to display the values as decimal numbers.

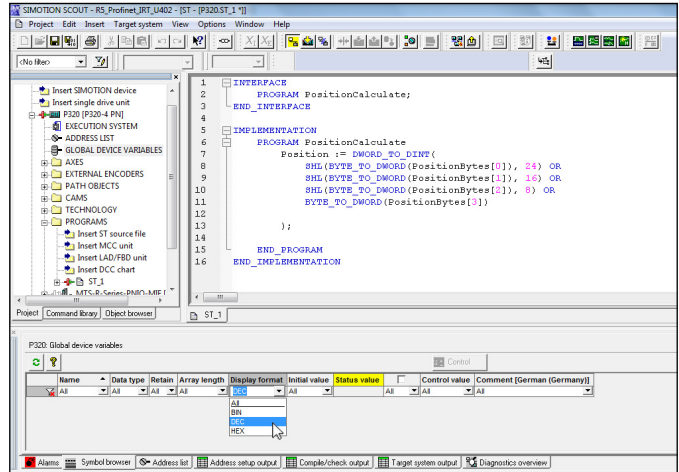

Fig. 97: Selecting the display format of the output values

4. In this example, the variable is named "Position". In this variable, the values of the input module "Position bytes" are summed up in a decimal number.

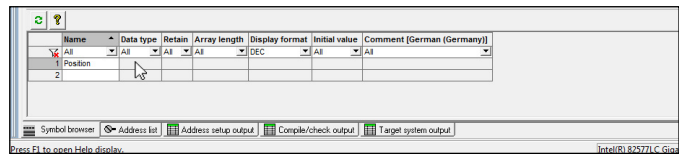

Fig. 98: Setting the name of the variable values

5. In the program created for converting the raw position data, a value in the format "Double INT (DINT)" is output as the result. For this reason, select "DINT" as the data type for the global device variables.

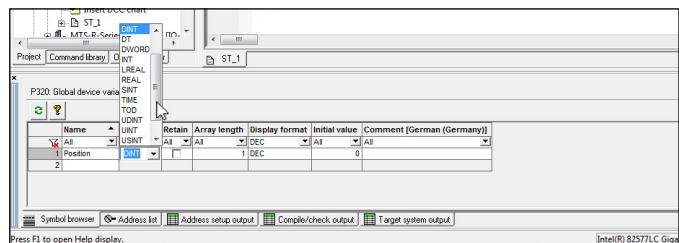

Fig. 99: Setting the data type of the global device variable

6. The created program "ST\_1" must be inserted into the execution system. To do this, double-click on "EXECUTION SYSTEM" in the menu on the left of the Software Configurator. The "Execution System" window will then open. Add the program "ST\_1. PositionCalculate" in the tab "Program assignment" to "Programs used" under the "IPOsynchronous Task" entry.

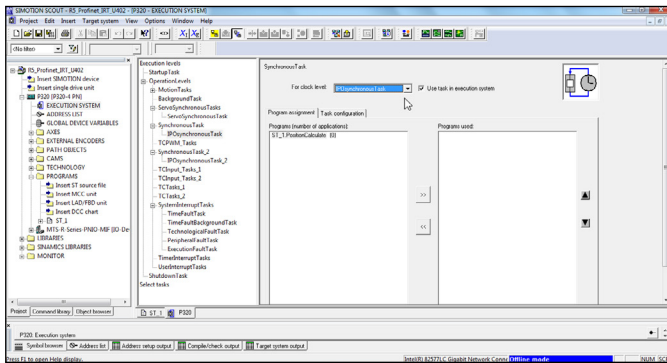

Fig. 100: Selecting the display format of the output values

7. Confirm the changes by clicking the "Yes" button.

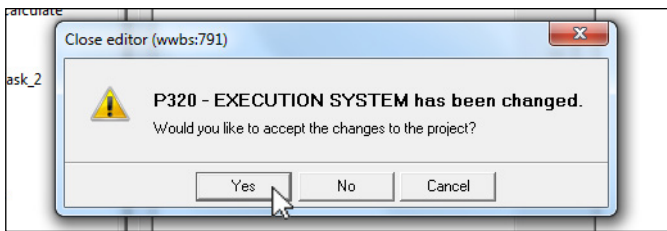

Fig. 101: Confirming changes to the execution system

8. To compile the program, click the "Accept and compile" button in the upper menu bar.

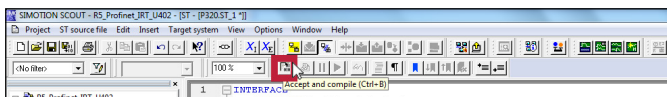

Fig. 102: Compiling of the program

9. The successful compilation is indicated by the following entries in the window at the bottom of the Software Configurator.

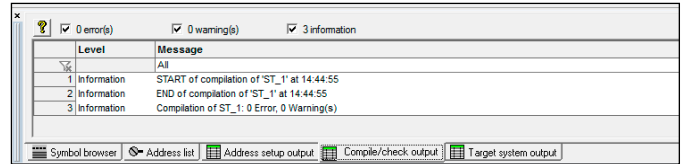

Fig. 103: Successful compilation of the program

10. Save and compile the created project by clicking the "Save project and compile changes" button in the menu bar.

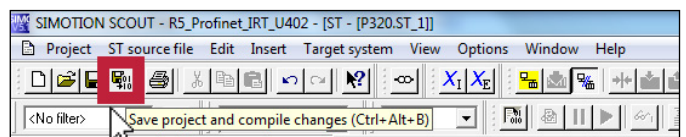

Fig. 104: Saving and compiling the project

11. To download the project to the controller, first click the "connect to selected target devices" button.

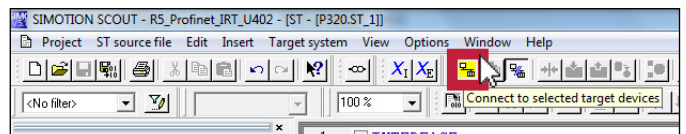

Fig. 105: Connecting with target device to download the project

12. Then click the "Download project to target system" button.

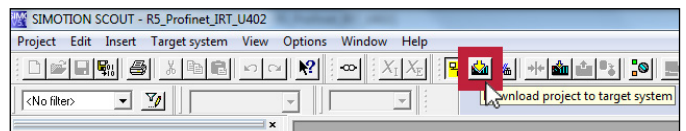

Fig. 106: Downloading the project to the target device

13. To start the project, click the "Control operating state..." button in the menu bar.

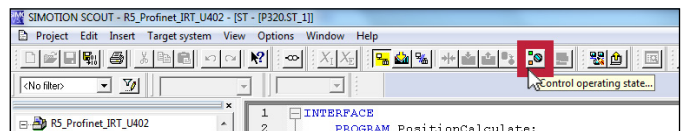

Fig. 107: Starting the project



14. The corresponding window will open. Click in this window the "RUN" button in the column "Control".

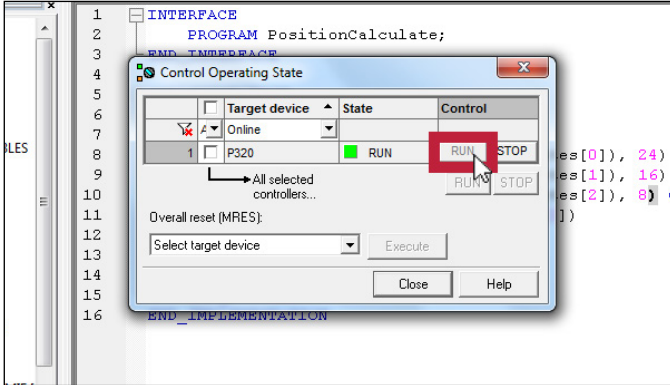

Fig. 108: Running the project to display the position values

15. In the "Global device variables" at the bottom of the software configurator, the raw position value is displayed in the column "Status value". In this example, the value is 231736. To obtain the position value, multiply this value by the resolution set on the controller and on the sensor.

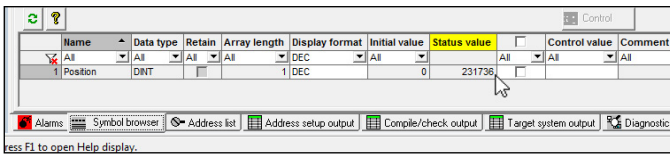

Fig. 109: Displaying the measure position value

## 7.9 Display of failure information

1. The R-Series V PROFINET can output failures such as "power supply out of the specified range" and "wrong number of magnets" (Fig. 66). To display these messages in the event of such failure, the parameters must be set so that failures are output. The following steps describe how these failures can be displayed.

In the hardware configurator, first mark the icon of the sensor on the network. Then click in the upper menu bar under "Station" the entry "Open ONLINE".

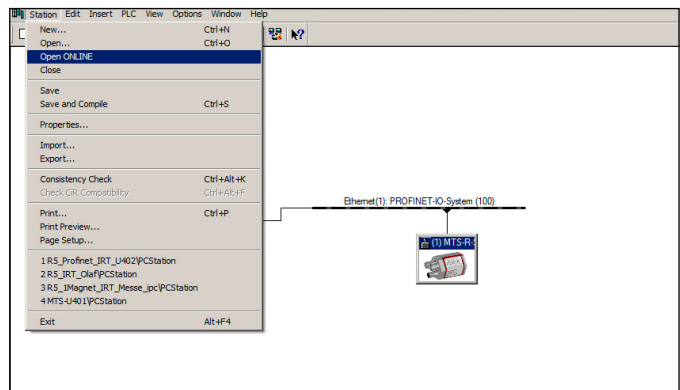

Fig. 110: Starting the hardware configurator (Diagnostics)

2. The "HW Config (Diagonstics)" window opens. In this window, double-click on the icon of the sensor on the network. The "Module Information" window of the sensor opens.

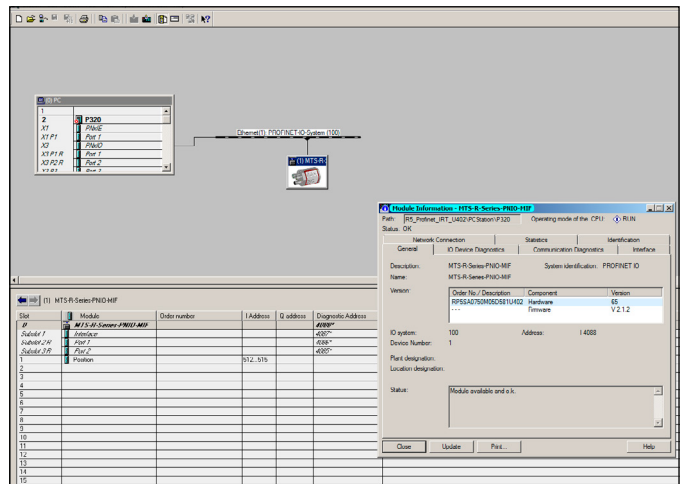

Fig. 111: Opening the window "Module Information"

3. In the "IO Device Diagnostics" tab of the "Module Information" window, current failure messages are displayed in the "Channel-specific Diagnostics" field. The following figure shows the failure message "Power supply failure".

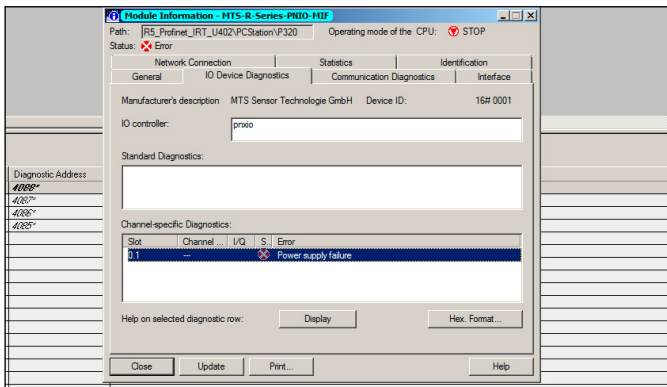

Fig. 112: Display of error messages in the "Module Information" window

4. For more information about this failure, click the "Hex. Format..." button. The window "IO Device Diagnostics in Hexadecimal Format" opens. In the field "Structured Display" under "ChannelErrorType" the error code 0011 is displayed in a hexadecimal number. This corresponds to a decimal number of 17. The alarm ID "17" means invalid operating voltage.

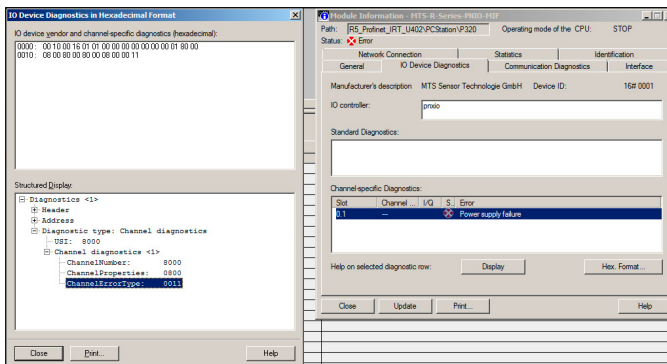

Fig. 113: Display failure messages as a hexadecimal number

## 8. TempoLink smart assistant with R-Series V PROFINET

The TempoLink smart assistant supports the R-Series V PROFINET. The TempoLink smart assistant can be used to read current status information of the sensor and to adjust settings for identification of the sensor in the network. In addition, the current parameter settings can be viewed via the TempoLink smart assistant. This allows the sensor to be checked offline, i.e. without integration into a network. For further information see the TempoLink smart assistant operation manual (document number: 551986).

## 9. Maintenance and troubleshooting

### 9.1 Error conditions, troubleshooting

See chapter "5. Operation" on page 22.

### 9.2 Maintenance

The sensor is maintenance-free.

### 9.3 Repair

Repairs of the sensor may be performed only by MTS Sensors or a repair facility explicitly authorized by MTS Sensors. For return see chapter "2.6 Return" on page 4.

### 9.4 List of spare parts

No spare parts are available for this sensor.

### 9.5 Transport and storage

The conditions of transport and storage of the sensor match the operating conditions mentioned in this document.

## 10. Removal from service/dismantling

The product contains electronic components and must be disposed of in accordance with the local regulations.

## 11. Technical data

### 11.1 Technical data Temposonics® R-Series V RP5

Output							
Interface	PROFINET RT PROFINET IRT version 2.3						
Data protocol	MTS Profile and Encoder Profile 4.1						
Data transmission rate	100 MBit/s (maximum)						
Measured value	Position, velocity/option: Simultaneous multi-position and multi-velocity measurements up to 30 magnets						
Measurement parameters							
Resolution: Position	0.5...100 µm (selectable)						
Cycle time	Stroke length	≤ 50 mm	≤ 715 mm	≤ 2000 mm	≤ 4675 mm	≤ 6350 mm	
	Cycle time	250 µs	500 µs	1000 µs	2000 µs	4000 µs	
Linearity deviation <sup>4</sup>	Stroke length	≤ 500 mm	> 500 mm				
	Linearity deviation	≤ ±50 µm	< 0.01 % F.S.				
	Optional internal linearity: Linearity tolerance (applies for the first magnet for multi-position measurement)						
	Stroke length	25...300 mm	300...600 mm	600...1200 mm	1200...3000 mm	3000...5000 mm	5000...6350 mm
	typical	± 15 µm	± 20 µm	± 25 µm	± 45 µm	± 85 µm	± 95 µm
	maximum	± 25 µm	± 30 µm	± 50 µm	± 90 µm	± 150 µm	± 190 µm
Repeatability	< ±0.001 % F.S. (minimum ±2.5 µm) typical						
Hysteresis	< 4 µm typical						
Temperature coefficient	< 15 ppm/K typical						
Operating conditions							
Operating temperature	-40...+85 °C (-40...+185 °F)						
Humidity	90 % relative humidity, no condensation						
Ingress protection	IP67 (connectors correctly fitted)						
Shock test	150 g/11 ms, IEC standard 60068-2-27						
Vibration test	30 g/10...2000 Hz, IEC standard 60068-2-6 (excluding resonant frequencies)						
EMC test	Electromagnetic emission according to EN 61000-6-3						
	Electromagnetic immunity according to EN 61000-6-2						
	The sensor meets the requirements of the EC directives and is marked with <b>CE</b>						
Magnet movement velocity	Magnet slider: Max. 10 m/s; U-magnet: Any; block magnet: Any						
Design/Material							
Sensor electronics housing	Aluminum (painted), zinc die cast						
Sensor profile	Aluminum						
Stroke length	25...6350 mm (1...250 in.)						
Mechanical mounting							
Mounting position	Any						
Mounting instruction	Please consult the technical drawings on <a href="#">page 9</a>						
Electrical connection							
Connection type	2 × M12 female connectors (5 pin), 1 × M12 male connector (4 pin)						
Operating voltage	+12...30 VDC ±20 % (9.6...36 VDC)						
Power consumption	Less than 4 W typical						
Dielectric strength	500 VDC (DC ground to machine ground)						
Polarity protection	Up to -36 VDC						
Overvoltage protection	Up to 36 VDC						

4/ With position magnet # 252 182

## 11.2 Technical data Temposonics® R-Series V RH5

Output						
Interface	PROFINET RT PROFINET IRT version 2.3					
Data protocol	MTS Profile and Encoder Profile 4.1					
Data transmission rate	100 MBit/s (maximum)					
Measured value	Position, velocity/option: Simultaneous multi-position and multi-velocity measurements up to 30 magnets					
Measurement parameters						
Resolution: Position	0.5...100 µm (selectable)					
Cycle time	Stroke length	≤ 50 mm	≤ 715 mm	≤ 2000 mm	≤ 4675 mm	≤ 7620 mm
	Cycle time	250 µs	500 µs	1000 µs	2000 µs	4000 µs
Linearity deviation <sup>5</sup>	Stroke length	≤ 500 mm	> 500 mm			
	Linearity deviation	≤ ±50 µm	< 0.01 % F.S.			
	Optional internal linearity: Linearity tolerance (applies for the first magnet for multi-position measurement)					
	Stroke length	25...300 mm	300...600 mm	600...1200 mm		
	typical	± 15 µm	± 20 µm	± 25 µm		
	maximum	± 25 µm	± 30 µm	± 50 µm		
Repeatability	< ±0.001 % F.S. (minimum ±2.5 µm) typical					
Hysteresis	< 4 µm typical					
Temperature coefficient	< 15 ppm/K typical					
Operating conditions						
Operating temperature	-40...+85 °C (-40...+185 °F)					
Humidity	90 % relative humidity, no condensation					
Ingress protection	IP67 (connectors correctly fitted)					
Shock test	150 g/11 ms, IEC standard 60068-2-27					
Vibration test	30 g/10...2000 Hz, IEC 60068-2-6 (excluding resonant frequencies) / RH5-J: 15 g/10...2000 Hz, IEC standard 60068-2-6 (excluding resonant frequencies)					
EMC test	Electromagnetic emission according to EN 61000-6-3					
	Electromagnetic immunity according to EN 61000-6-2					
	The sensor meets the requirements of the EC directives and is marked with <b>CE</b>					
Operating pressure	350 bar (5,076 psi)/700 bar (10,153 psi) peak (at 10 × 1 min) for sensor rod/RH5-J: 800 bar (11,603 psi)					
Magnet movement velocity	Any					
Design/Material						
Sensor electronics housing	Aluminum (painted), zinc die cast					
Sensor flange	Stainless steel 1.4305 (AISI 303)					
Sensor rod	Stainless steel 1.4306 (AISI 304L)/RH5-J: Stainless steel 1.4301 (AISI 304)					
Stroke length	25...7620 mm (1...300 in.)/RH5-J: 25...5900 mm (1...232 in.)					
Mechanical mounting						
Mounting position	Any					
Mounting instruction	Please consult the technical drawings on <a href="#">page 10</a>					
Electrical connection						
Connection type	2 × M12 female connectors (5 pin), 1 × M12 male connector (4 pin)					
Operating voltage	+12...30 VDC ±20 % (9.6...36 VDC)					
Power consumption	Less than 4 W typical					
Dielectric strength	500 VDC (DC ground to machine ground)					
Polarity protection	Up to -36 VDC					
Overvoltage protection	Up to 36 VDC					

5/ With position magnet # 251 416-2

## 12. Appendix I

### Safety Declaration

Dear Customer,

If you return one or several sensors for checking or repair, we need you to sign a safety declaration. The purpose of this declaration is to ensure that the returned items do not contain residues of harmful substances and / or that people handling these items will not be in danger.

MTS Sensors order number: \_\_\_\_\_ Sensor type(s): \_\_\_\_\_

Serial number(s): \_\_\_\_\_ Sensor length(s): \_\_\_\_\_

**The sensor has been in contact with the following materials:**

Do not specify chemical formulas.  
Please include safety data sheets of the substances, if applicable.

In the event of suspected penetration of substances into the sensor, consult MTS Sensors to determine measures to be taken before shipment.

**Short description of malfunction:**

#### Corporate information

Company: \_\_\_\_\_

Address: \_\_\_\_\_

\_\_\_\_\_

#### Contact partner

Name: \_\_\_\_\_

Phone: \_\_\_\_\_

E-mail: \_\_\_\_\_

We hereby certify that the measuring equipment has been cleaned and neutralized.  
Equipment handling is safe. Personnel exposure to health risks during transport and repair is excluded.

Stamp

Signature

Date

#### GERMANY

**MTS Sensor Technologie GmbH & Co.KG**  
Auf dem Schüffel 9  
58513 Lüdenscheid, Germany  
Tel. +49-23 51-95 87 0  
Fax. +49-23 51-5 64 91  
info.de@mtssensors.com  
www.mtssensors.com

#### USA

**MTS Systems Corporation Sensors Division**  
3001 Sheldon Drive  
Cary, N.C. 27513, USA  
Tel. +1 919 677-0100  
Fax +1 919 677-0200  
info.us@mtssensors.com  
www.mtssensors.com

### 13. Appendix II

## CYLINDER PORT DETAILS

### PORT DETAIL (PD) FOR RH5-S:

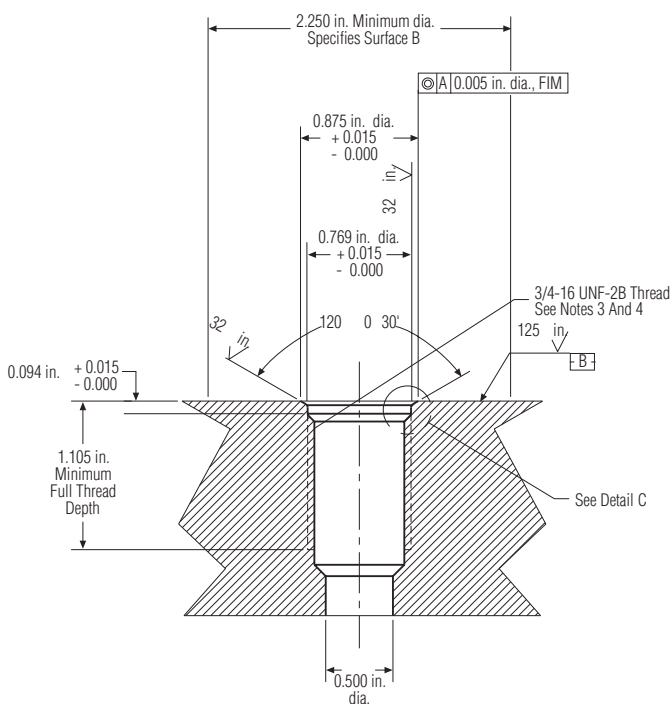

#### NOTES:

1. Dimensions and tolerances based on ANSI Y14.5-1982.
2. MTS has extracted all pertinent information from MS33649 to generate this document.
3. PD must be square with surface B within 0.005 FIM across 2.250 dia minimum.
4. PD must be concentric with 2.250 dia within 0.030 FIM and with 0.769 dia within 0.005 FIM.
5. Surface texture ANSI B46.1-1978
6. Use O-ring MTS part number 560315 for correct sealing.
7. The thread design shall have sufficient threads to meet strength requirements of material used.
8. Finish counter-bore shall be free from longitudinal and spiral tool marks. Annular tool marks up to 32 microinches maximum will be permissible.

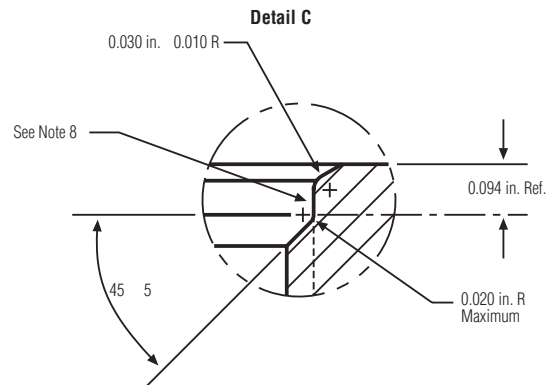

### PORT DETAIL (PD) FOR RH5-T:

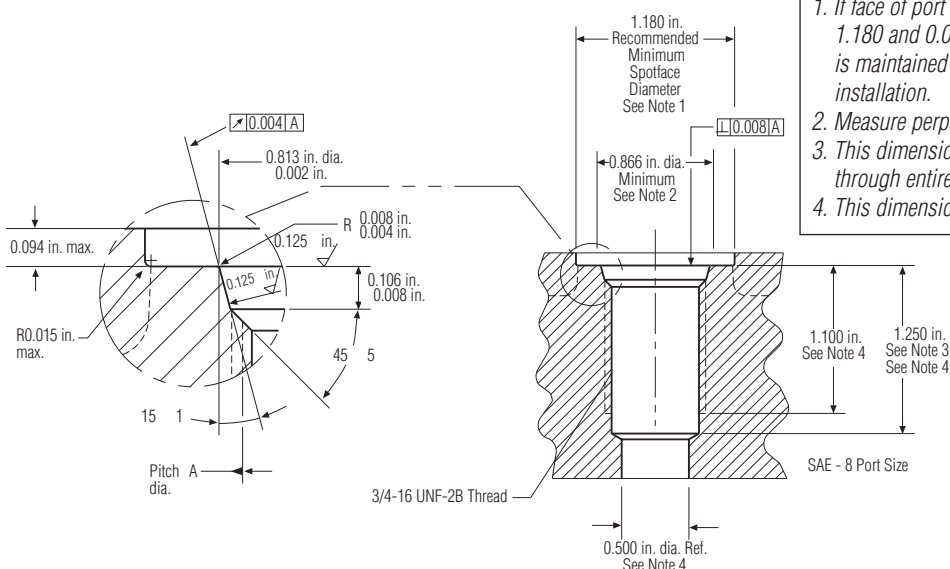

#### NOTES:

1. If face of port is on a machined surface, dimensions 1.180 and 0.094 need not apply as long as R0.008/0.004 is maintained to avoid damage to the O-ring during installation.
2. Measure perpendicularity to A at this diameter.
3. This dimension applies when tap drill cannot pass through entire boss.
4. This dimension does not conform to SAE J1926/1.

## 14. Glossary

### E

#### Encoder Profile

The encoder profile corresponds to the specification of the encoder profile V4.1 (PNO no. 3.162). With this profile, the position and the velocity of one magnet can be measured and transferred simultaneously. (→ MTS Profile)

#### Extrapolation

The native measurement cycle time of a sensor increases with the stroke length. With extrapolation, the sensor is able to report data faster than the native cycle time, independent of the stroke length of the sensor. Without extrapolation, if data is requested faster than the native cycle time, the last measured value is repeated.

### F

#### FIR Filter

The FIR filter (**Finite Impulse Response**) is used to smooth the measured position value before output. To determine the output value, only input values corresponding to the window (filter window size) are used for filter calculation. The output value is calculated from these input values in the form of a moving average value. (→ IIR Filter)

### G

#### GSDML

The properties and functions of a PROFINET IO field device are described in a GSDML file (**General Station Description**). The XML-based GSDML file contains all relevant data that are important for the implementation of the device in the controller as well as for data exchange during operation. The GSDML file of the R-Series V PROFINET is available on the homepage [www.mtssensors.com](http://www.mtssensors.com).

### I

#### IIR Filter

The IIR filter (**Infinite Impulse Response**) is used to smooth the measured position value before output. To determine the output value, the input values corresponding to the window (filter window size) are used for the filter calculation. The previous values are also taken into account when calculating the output value. (→ FIR Filter)

#### Internal Linearization

The internal linearization offers an improved linearity for an overall higher accuracy of the position measurement. The internal linearization is set for the sensor during production.

#### IRT

With PROFINET IRT (**Isochronous Real Time**) a clock-synchronous data transmission takes place. The application, the data transmission as well as the device cycle are synchronous. IRT enables a clock-synchronous data exchange with a minimum cycle time of 250 µs in the network. The R-Series V PROFINET supports PROFINET RT and IRT. (→ RT)

### M

#### Measuring Direction

When moving the position magnet, the position and velocity values increase in the measuring direction.

- Forward: Values increasing from sensor electronics housing to rod end/profile end
- Reverse: Values increasing from rod end/profile end to sensor electronics housing

#### MTS Profile

The MTS profile was developed by MTS Sensors and is tailored to the characteristics of magnetostrictive position sensors. With this profile, the positions and velocities of up to 30 magnets can be reported and transferred simultaneously. (→ Encoder Profile)

#### Multi-position measurement

During the measurement cycle, the positions of every magnet on the sensor are simultaneously reported. The velocity is continuously calculated based on these changing position values as the magnets are moved.

### O

#### Offset

A value which will be added or deducted to the actual position value. This leads to a shift of the measurement range start. (→ Preset)

### P

#### PLC

A PLC (**Programmable Logic Controller**) is a device for controlling or regulating machines and systems.

#### Preset

With the preset, a value is entered for the current position which is to be output at this position in the future. The difference between the entered value and the currently measured position is calculated as an offset. (→ Offset)

#### PROFINET

PROFINET (**Process Field Network**) is an Industrial Ethernet interface and is managed by the **PROFIBUS Nutzerorganisation e.V. (PNO)**. The R-Series V PROFINET and its corresponding GSDML file are certified by the PNO.

### R

#### RO

RO (**Read Only**) means that the value of the variable can only be read but is not modifiable.

#### RT

With PROFINET RT (**Real Time**) the data exchange is without clock synchronization. In this case, the application, the data transmission and the field devices operate according to their own processing cycle. The R-Series V PROFINET supports PROFINET RT and IRT. (→ IRT)

#### RW

RW (**Read/Write**) means that the value of the variable can be read and written. The value of the variable is modifiable.



**UNITED STATES** 3001 Sheldon Drive  
**MTS Systems Corporation** Cary, N.C. 27513  
**Sensors Division** Phone: +1 919 677-0100  
Americas & APAC Region E-mail: info.us@mtssensors.com

---

**GERMANY** Auf dem Schüffel 9  
**MTS Sensor Technologie** 58513 Lüdenscheid  
**GmbH & Co. KG** Phone: +49 2351 9587-0  
EMEA Region & India E-mail: info.de@mtssensors.com

---

**ITALY** Phone: +39 030 988 3819  
Branch Office E-mail: info.it@mtssensors.com

---

**FRANCE** Phone: +33 1 58 4390-28  
Branch Office E-mail: info.fr@mtssensors.com

---

**UK** Phone: +44 79 44 15 03 00  
Branch Office E-mail: info.uk@mtssensors.com

---

**SCANDINAVIA** Phone: +46 70 29 91 281  
Branch Office E-mail: info.sca@mtssensors.com

---

**CHINA** Phone: +86 21 2415 1000 / 2415 1001  
Branch Office E-mail: info.cn@mtssensors.com

---

**JAPAN** Phone: +81 3 6416 1063  
Branch Office E-mail: info.jp@mtssensors.com

---

**Document Part Number:**  
551973 Revision C (EN) 09/2020



[www.mtssensors.com](http://www.mtssensors.com)